

SECTION **SEC**

SECURITY CONTROL SYSTEM

A
B
C
D
E
F
G
H
I
J
L
M
N
O
P

CONTENTS

<p>BASIC INSPECTION 5</p> <p>DIAGNOSIS AND REPAIR WORK FLOW 5</p> <p style="padding-left: 20px;">Work Flow5</p> <p>INSPECTION AND ADJUSTMENT 8</p> <p>ECM RE-COMMUNICATING FUNCTION8</p> <p style="padding-left: 20px;">ECM RE-COMMUNICATING FUNCTION : De- scription8</p> <p style="padding-left: 20px;">ECM RE-COMMUNICATING FUNCTION : Spe- cial Repair Requirement8</p> <p>SYSTEM DESCRIPTION 9</p> <p>INTELLIGENT KEY SYSTEM/ENGINE</p> <p>START FUNCTION 9</p> <p style="padding-left: 20px;">System Diagram9</p> <p style="padding-left: 20px;">System Description9</p> <p style="padding-left: 20px;">Component Parts Location13</p> <p style="padding-left: 20px;">Component Description14</p> <p>INFINITI VEHICLE IMMOBILIZER SYSTEM-</p> <p>NATS16</p> <p style="padding-left: 20px;">System Diagram16</p> <p style="padding-left: 20px;">System Description16</p> <p style="padding-left: 20px;">Component Parts Location17</p> <p style="padding-left: 20px;">Component Description18</p> <p>VEHICLE SECURITY SYSTEM20</p> <p style="padding-left: 20px;">System Diagram20</p> <p style="padding-left: 20px;">System Description20</p> <p style="padding-left: 20px;">Component Parts Location22</p> <p style="padding-left: 20px;">Component Description23</p> <p>DIAGNOSIS SYSTEM (BCM)24</p> <p>COMMON ITEM24</p> <p style="padding-left: 20px;">COMMON ITEM : CONSULT-III Function (BCM - COMMON ITEM)24</p> <p>INTELLIGENT KEY25</p>	<p>INTELLIGENT KEY : CONSULT-III Function (BCM - INTELLIGENT KEY)25</p> <p>THEFT ALM29</p> <p style="padding-left: 20px;">THEFT ALM : CONSULT-III Function (BCM - THEFT)29</p> <p>IMMU30</p> <p style="padding-left: 20px;">IMMU : CONSULT-III Function (BCM - IMMU)30</p> <p>DIAGNOSIS SYSTEM (IPDM E/R)31</p> <p style="padding-left: 20px;">CONSULT-III Function (IPDM E/R)31</p> <p>DTC/CIRCUIT DIAGNOSIS33</p> <p>P1610 LOCK MODE33</p> <p style="padding-left: 20px;">Description33</p> <p style="padding-left: 20px;">DTC Logic33</p> <p style="padding-left: 20px;">Diagnosis Procedure33</p> <p>P1611 ID DISCORD, IMMU-ECM34</p> <p style="padding-left: 20px;">Description34</p> <p style="padding-left: 20px;">DTC Logic34</p> <p style="padding-left: 20px;">Diagnosis Procedure34</p> <p>P1612 CHAIN OF ECM-IMMU36</p> <p style="padding-left: 20px;">Description36</p> <p style="padding-left: 20px;">DTC Logic36</p> <p style="padding-left: 20px;">Diagnosis Procedure36</p> <p>P1614 CHAIN OF IMMU-KEY37</p> <p style="padding-left: 20px;">Description37</p> <p style="padding-left: 20px;">DTC Logic37</p> <p style="padding-left: 20px;">Diagnosis Procedure37</p> <p>P1615 DIFFERENCE OF KEY40</p> <p style="padding-left: 20px;">Description40</p> <p style="padding-left: 20px;">DTC Logic40</p> <p style="padding-left: 20px;">Diagnosis Procedure40</p> <p>B2190 NATS ANTENNA AMP.41</p> <p style="padding-left: 20px;">Description41</p> <p style="padding-left: 20px;">DTC Logic41</p>
---------------------------------------------------------------------------------------------------------------------------------------------------------------------------------------------------------------------------------------------------------------------------------------------------------------------------------------------------------------------------------------------------------------------------------------------------------------------------------------------------------------------------------------------------------------------------------------------------------------------------------------------------------------------------------------------------------------------------------------------------------------------------------------------------------------------------------------------------------------------------------------------------------------------------------------------------------------------------------------------------------------------------------------------------------------------------------------------------------------------------------------------------------------------------------------------------------------------------------------------------------------------------------------------------------------------------------------------------------------------------------------------------------------------------------------------------------------------------------------------------------------------------------------------------------------------------------------------------------------------------------------------------------------------------------------------------------------------------------	-------------------------------------------------------------------------------------------------------------------------------------------------------------------------------------------------------------------------------------------------------------------------------------------------------------------------------------------------------------------------------------------------------------------------------------------------------------------------------------------------------------------------------------------------------------------------------------------------------------------------------------------------------------------------------------------------------------------------------------------------------------------------------------------------------------------------------------------------------------------------------------------------------------------------------------------------------------------------------------------------------------------------------------------------------------------------------------------------------------------------------------------------------------------------------------------------------------------------------------------------------------------------------------------------------------------------------------------------------------------------------------------------------------------------------------------------------------------------------------------------------------------------------------------------------------------------------------------------------------------------------------------------------------------------------------------------------------------------------------------------------------------------------------------

SEC

Diagnosis Procedure	41	DTC Logic	62
B2191 DIFFERENCE OF KEY	44	Diagnosis Procedure	62
Description	44	B2603 SHIFT POSITION	64
DTC Logic	44	Description	64
Diagnosis Procedure	44	DTC Logic	64
B2192 ID DISCORD, IMMU-ECM	45	Diagnosis Procedure	64
Description	45	B2604 SHIFT POSITION	67
DTC Logic	45	Description	67
Diagnosis Procedure	45	DTC Logic	67
B2193 CHAIN OF ECM-IMMU	47	Diagnosis Procedure	67
Description	47	B2605 SHIFT POSITION	69
DTC Logic	47	Description	69
Diagnosis Procedure	47	DTC Logic	69
B2195 ANTI-SCANNING	48	Diagnosis Procedure	69
Description	48	B2606 STEERING LOCK RELAY	71
DTC Logic	48	Description	71
Diagnosis Procedure	48	DTC Logic	71
B2013 STEERING LOCK UNIT	49	Diagnosis Procedure	71
Description	49	B2607 STEERING LOCK RELAY	72
DTC Logic	49	Description	72
Diagnosis Procedure	49	DTC Logic	72
B2014 CHAIN OF STRG-IMMU	50	Diagnosis Procedure	72
Description	50	B2608 STARTER RELAY	74
DTC Logic	50	Description	74
Diagnosis Procedure	50	DTC Logic	74
B2555 STOP LAMP	53	Diagnosis Procedure	74
Description	53	B2609 STEERING STATUS	76
DTC Logic	53	Description	76
Diagnosis Procedure	53	DTC Logic	76
Component Inspection	54	Diagnosis Procedure	76
B2556 PUSH-BUTTON IGNITION SWITCH	55	B260B STEERING LOCK UNIT	80
Description	55	Description	80
DTC Logic	55	DTC Logic	80
Diagnosis Procedure	55	Diagnosis Procedure	80
Component Inspection	56	B260C STEERING LOCK UNIT	81
B2557 VEHICLE SPEED	57	Description	81
Description	57	DTC Logic	81
DTC Logic	57	Diagnosis Procedure	81
Diagnosis Procedure	57	B260D STEERING LOCK UNIT	82
B2560 STARTER CONTROL RELAY	58	Description	82
Description	58	DTC Logic	82
DTC Logic	58	Diagnosis Procedure	82
Diagnosis Procedure	58	B260F ENGINE STATUS	83
B2601 SHIFT POSITION	59	Description	83
Description	59	DTC Logic	83
DTC Logic	59	Diagnosis Procedure	83
Diagnosis Procedure	59	B26E8 CLUTCH INTERLOCK SWITCH	84
Component Inspection	61	Description	84
B2602 SHIFT POSITION	62	DTC Logic	84
Description	62	Diagnosis Procedure	84

Component Inspection	85	B210D STARTER RELAY	107	A
		Description	107	
B26E9 STEERING STATUS	86	DTC Logic	107	B
Description	86	Diagnosis Procedure	107	
DTC Logic	86	B210E STARTER RELAY	108	C
Diagnosis Procedure	86	Description	108	
B26EA KEY REGISTRATION	87	DTC Logic	108	
Description	87	Diagnosis Procedure	108	D
DTC Logic	87	B210F SHIFT POSITION/CLUTCH INTER-LOCK SWITCH	110	E
Diagnosis Procedure	87	Description	110	
B2612 STEERING STATUS	88	DTC Logic	110	
Description	88	Diagnosis Procedure	110	F
DTC Logic	88	B2110 SHIFT POSITION/CLUTCH INTER-LOCK SWITCH	112	G
Diagnosis Procedure	88	Description	112	
B2617 STARTER RELAY CIRCUIT	92	DTC Logic	112	
Description	92	Diagnosis Procedure	112	H
DTC Logic	92	POWER SUPPLY AND GROUND CIRCUIT ..	114	
Diagnosis Procedure	92	BCM	114	I
B2619 BCM	94	BCM : Diagnosis Procedure	114	J
Description	94	IPDM E/R	114	
DTC Logic	94	IPDM E/R : Diagnosis Procedure	114	
Diagnosis Procedure	94	HOOD SWITCH	116	
B261E VEHICLE TYPE	95	Description	116	
Description	95	Component Function Check	116	
DTC Logic	95	Diagnosis Procedure	116	
Diagnosis Procedure	95	Component Inspection	117	
B261F ASCD CLUTCH SWITCH	96	SECURITY INDICATOR LAMP	118	SEC
Description	96	Description	118	
DTC Logic	96	Component Function Check	118	
Diagnosis Procedure	96	Diagnosis Procedure	118	L
Component Inspection	97	HORN FUNCTION	120	
B2108 STEERING LOCK RELAY	98	Description	120	
Description	98	Component Function Check	120	M
DTC Logic	98	Diagnosis Procedure	120	
Diagnosis Procedure	98	HEADLAMP FUNCTION	122	
B2109 STEERING LOCK RELAY	100	Description	122	N
Description	100	Component Function Check	122	
DTC Logic	100	Diagnosis Procedure	122	O
Diagnosis Procedure	100	INTELLIGENT KEY SYSTEM/ENGINE START FUNCTION	123	
B210A STEERING LOCK UNIT	101	Wiring Diagram - INTELLIGENT KEY SYSTEM/ ENGINE START FUNCTION -	123	P
Description	101	INFINITI VEHICLE IMMOBILIZER SYSTEM-NATS	135	
DTC Logic	101	Wiring Diagram - INFINITI VEHICLE IMMOBILIZ- ER SYSTEM -	135	
Diagnosis Procedure	101	VEHICLE SECURITY SYSTEM	146	
B210B STARTER CONTROL RELAY	105			
Description	105			
DTC Logic	105			
Diagnosis Procedure	105			
B210C STARTER CONTROL RELAY	106			
Description	106			
DTC Logic	106			
Diagnosis Procedure	106			

Wiring Diagram - VEHICLE SECURITY SYSTEM	206
-	146
ECU DIAGNOSIS INFORMATION	156
BCM (BODY CONTROL MODULE)	156
Reference Value	156
Wiring Diagram - BCM -	179
Fail-safe	184
DTC Inspection Priority Chart	186
DTC Index	187
IPDM E/R (INTELLIGENT POWER DISTRIBUTION MODULE ENGINE ROOM)	190
Reference Value	190
Wiring Diagram - IPDM E/R -	197
Fail-safe	200
DTC Index	202
SYMPTOM DIAGNOSIS	203
ENGINE DOES NOT START WHEN INTELLIGENT KEY IS INSIDE OF VEHICLE	203
Description	203
Diagnosis Procedure	203
STEERING DOES NOT LOCK	204
Description	204
Diagnosis Procedure	204
SECURITY INDICATOR LAMP DOES NOT TURN ON OR FLASH	205
Description	205
Diagnosis Procedure	205
VEHICLE SECURITY SYSTEM CANNOT BE SET	206
INTELLIGENT KEY	206
INTELLIGENT KEY : Description	206
INTELLIGENT KEY : Diagnosis Procedure	206
DOOR REQUEST SWITCH	206
DOOR REQUEST SWITCH : Description	206
DOOR REQUEST SWITCH : Diagnosis Procedure	206
VEHICLE SECURITY ALARM DOES NOT ACTIVATE	208
Description	208
Diagnosis Procedure	208
INTELLIGENT KEY INSERT INFORMATION DOES NOT OPERATE	209
Description	209
Diagnosis Procedure	209
PANIC ALARM FUNCTION DOES NOT OPERATE	211
Description	211
Diagnosis Procedure	211
PRECAUTION	212
PRECAUTIONS	212
Precaution for Supplemental Restraint System (SRS) "AIR BAG" and "SEAT BELT PRE-TENSIONER"	212
Service Procedure Precautions for Models with a Pop-up Roll Bar	212
Precautions Necessary for Steering Wheel Rotation After Battery Disconnection	212
Precaution for Procedure without Cowl Top Cover	213
Precaution for Battery Service	213
REMOVAL AND INSTALLATION	214
KEY SLOT	214
Exploded View	214
Removal and Installation	214
PUSH BUTTON IGNITION SWITCH	215
Exploded View	215
Removal and Installation	215

DIAGNOSIS AND REPAIR WORK FLOW

< BASIC INSPECTION >

BASIC INSPECTION

DIAGNOSIS AND REPAIR WORK FLOW

Work Flow

INFOID:000000006471861

OVERALL SEQUENCE

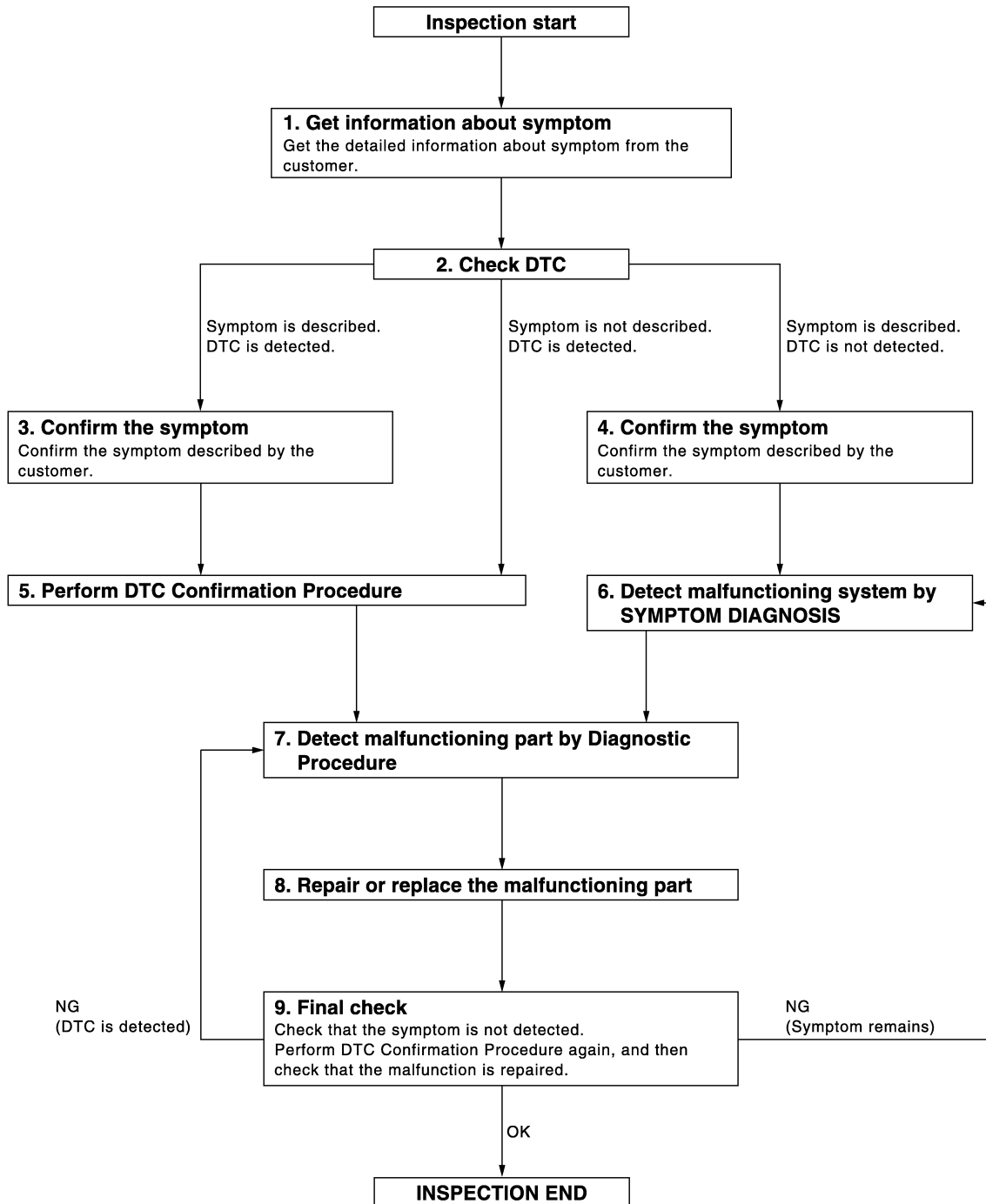

A
B
C
D
E
F
G
H
I
J
L
M
N
O
P

SEC

DETAILED FLOW

JMKIA3449GB

DIAGNOSIS AND REPAIR WORK FLOW

< BASIC INSPECTION >

1.GET INFORMATION ABOUT SYMPTOM

Get detailed information from the customer about the symptom (the condition and the environment when the incident/malfunction occurs).

>> GO TO 2.

2.CHECK DTC

1. Check BCM and IPDM E/R for DTC.
2. Perform the following procedure if DTC is detected.
 - Record DTC and freeze frame data (Print them out using CONSULT-III.)
 - Erase DTC.
 - Study the relationship between the cause detected by DTC and the symptom described by the customer.
3. Check related service bulletins for information.

Are any symptoms described and any DTC detected?

Symptom is described, DTC is detected>>GO TO 3.

Symptom is described, DTC is not detected>>GO TO 4.

Symptom is not described, DTC is detected>>GO TO 5.

3.CONFIRM THE SYMPTOM

Confirm the symptom described by the customer.

Connect CONSULT-III to the vehicle in the "DATA MONITOR" mode and check real time diagnosis results.

Verify relation between the symptom and the condition when the symptom is detected.

>> GO TO 5.

4.CONFIRM THE SYMPTOM

Confirm the symptom described by the customer.

Connect CONSULT-III to the vehicle in the "DATA MONITOR " mode and check real time diagnosis results.

Verify relation between the symptom and the condition when the symptom is detected.

>> GO TO 6.

5.PERFORM DTC CONFIRMATION PROCEDURE

Perform DTC Confirmation Procedure for the detected DTC, and then check that DTC is detected again.

At this time, always connect CONSULT-III to the vehicle, and check diagnostic results in real time.

If two or more DTCs are detected, refer to [SEC-186. "DTC Inspection Priority Chart"](#) (BCM) or [SEC-187. "DTC Index"](#) (IPDM E/R), and determine trouble diagnosis order.

Is DTC detected?

YES >> GO TO 7.

NO >> Refer to [GI-43. "Intermittent Incident"](#).

6.DETECT MALFUNCTIONING SYSTEM BY SYMPTOM DIAGNOSIS

Detect malfunctioning system according to SYMPTOM DIAGNOSIS based on the confirmed symptom in step 4, and determine the trouble diagnosis order based on possible causes and symptom.

>> GO TO 7.

7.DETECT MALFUNCTIONING PART BY DIAGNOSTIC PROCEDURE

Inspect according to Diagnostic Procedure of the system.

NOTE:

The Diagnostic Procedure is described based on open and short circuit inspection.

Is malfunctioning part detected?

YES >> GO TO 8.

NO >> Check voltage of related BCM terminals using CONSULT-III.

8.REPAIR OR REPLACE THE MALFUNCTIONING PART

1. Repair or replace the malfunctioning part.

DIAGNOSIS AND REPAIR WORK FLOW

< BASIC INSPECTION >

2. Reconnect parts or connectors disconnected during Diagnostic Procedure again after repair and replacement.
3. Check DTC. If DTC is detected, erase it.

>> GO TO 9.

9. FINAL CHECK

When DTC is detected in step 2, perform DTC Confirmation Procedure or Component Function Check again, and then check that the malfunction is repaired securely.

When symptom is described by the customer, refer to confirmed symptom in step 3 or 4, and check that the symptom is not detected.

Does the symptom reappear?

YES (DTC is detected)>>GO TO 7.

YES (Symptom remains)>>GO TO 6.

NO >> INSPECTION END

A
B
C
D
E
F
G
H
I
J
L
M
N
O
P

SEC

INSPECTION AND ADJUSTMENT

< BASIC INSPECTION >

INSPECTION AND ADJUSTMENT ECM RE-COMMUNICATING FUNCTION

ECM RE-COMMUNICATING FUNCTION : Description

INFOID:000000006471862

Performing the following procedure can automatically activate re-communication of ECM and BCM, but only when the ECM is replaced with a new one*.

*: New one means a virgin ECM that is never energized on-board.

(In this step, initialization procedure by CONSULT-III is not necessary)

NOTE:

- When registering new Key IDs or replacing the ECM that is not brand new, refer to **CONSULT-III Operation Manual NATS-IVIS/NVIS**.
- If multiple keys are attached to the key holder, separate them before beginning work.
- Distinguish keys with unregistered key IDs from those with registered IDs.

ECM RE-COMMUNICATING FUNCTION : Special Repair Requirement

INFOID:000000006471863

1. PERFORM ECM RECOMMUNICATING FUNCTION

1. Install ECM.
2. Insert the registered Intelligent Key* into key slot, turn ignition switch to "ON".
*: To perform this step, use the key that is used before performing ECM replacement.
3. Maintain ignition switch in the "ON" position for 5 seconds or more.
4. Turn ignition switch to "OFF".
5. Start engine.

Can engine be started?

YES >> Procedure is complete.

NO >> Initialize control unit. Refer to CONSULT-III Operation Manual NATS-IVIS/NVIS.

INTELLIGENT KEY SYSTEM/ENGINE START FUNCTION

< SYSTEM DESCRIPTION >

SYSTEM DESCRIPTION

INTELLIGENT KEY SYSTEM/ENGINE START FUNCTION

System Diagram

INFOID:000000006471864

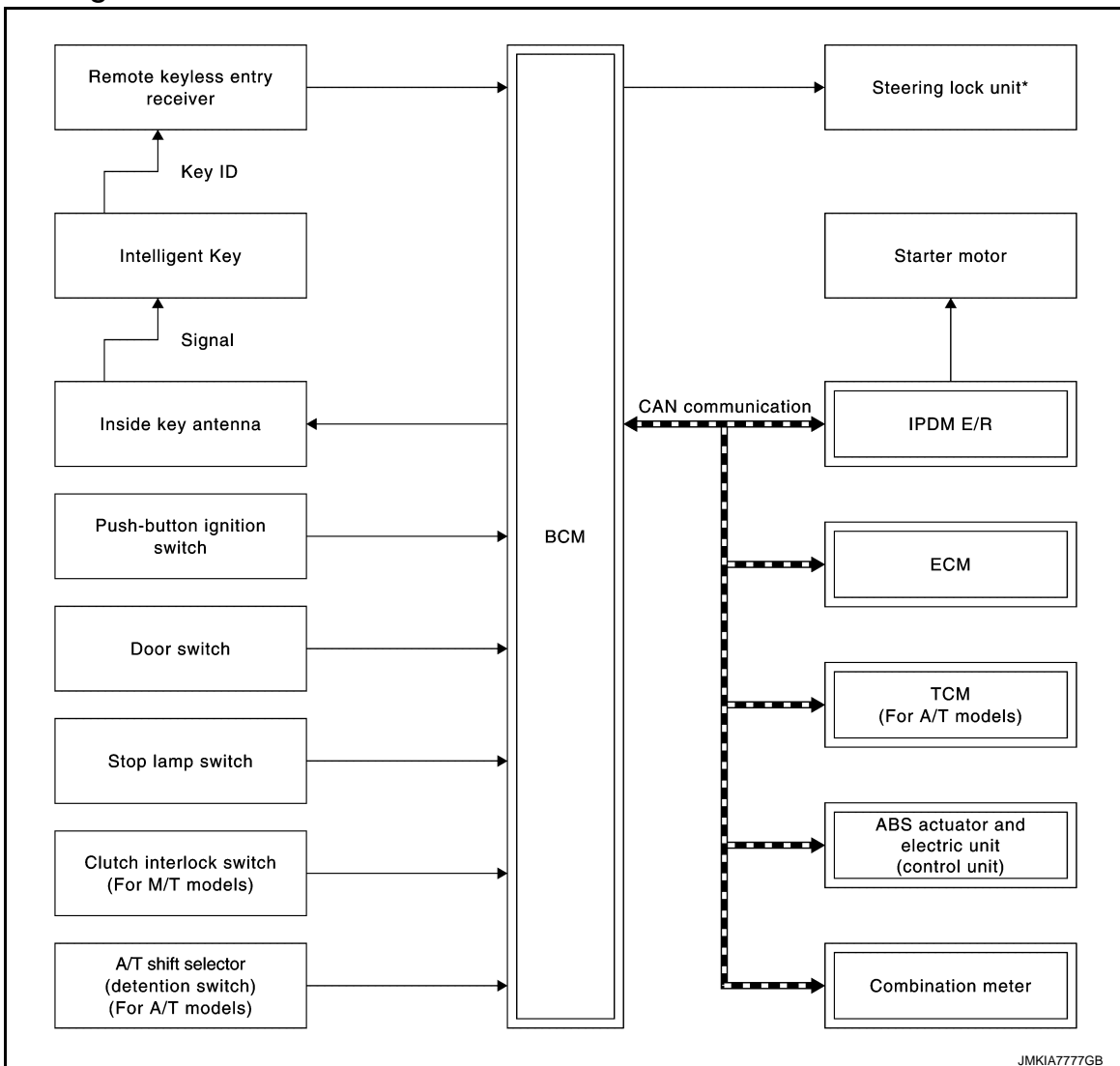

*: Models with steering lock unit

System Description

INFOID:000000006471865

SYSTEM DESCRIPTION

- The engine start function of Intelligent Key system is a system that makes it possible to start and stop the engine without removing the key. It verifies an electronic ID using two-way communication when pressing the push-button ignition switch while carrying the Intelligent Key, which operates based on the results of electronic ID verification of Intelligent Key using two-way communication between the Intelligent Key and the vehicle.

NOTE:

- The driver should carry the Intelligent Key at all times.
- Intelligent Key has 2 IDs [Intelligent Key and IVIS (NATS)]. It can perform the door lock/unlock operation and the push-button ignition switch operation when the registered Intelligent Key is carried.
- When the Intelligent Key battery is discharged, it can be used as emergency back-up by inserting the Intelligent Key to the key slot. At that time, perform the IVIS (NATS) ID verification. If it is used when the Intelligent Key is carried, perform the Intelligent Key ID verification.
- If the ID is successfully verified, and when push-button ignition switch is pressed, steering lock is released and the engine can be started (Models with steering lock unit).

A
B
C
D
E
F
G
H
I
J
L
M
N
O
P

SEC

INTELLIGENT KEY SYSTEM/ENGINE START FUNCTION

< SYSTEM DESCRIPTION >

- Up to 4 Intelligent Keys can be registered (Including the standard Intelligent Key) upon request from the customer.

NOTE:

Refer to [DLK-15. "INTELLIGENT KEY SYSTEM : System Description"](#) for any functions other than engine start function of Intelligent Key system.

PRECAUTIONS FOR INTELLIGENT KEY SYSTEM

In the Intelligent Key system, the transponder [the chip for IVIS (NATS) ID verification] is integrated into the Intelligent Key. (For the conventional models, it is integrated into the mechanical key.) Therefore, the mechanical key cannot perform ID verification, and thus it cannot start the engine. Instead, IVIS (NATS) ID verification can be performed by inserting the Intelligent Key to the key slot, and then it can start the engine.

OPERATION WHEN INTELLIGENT KEY IS CARRIED

Models with steering lock unit

1. When the push-button ignition switch is pressed, the BCM activates the inside key antenna and transmits the request signal to the Intelligent Key.
2. The Intelligent Key receives the request signal and transmits the Intelligent Key ID signal to the BCM via the remote keyless entry receiver.
3. The Intelligent Key receives the Intelligent Key ID signal and verifies it with the registered ID.
4. BCM transmits the steering lock unlock signal to steering lock unit and IPDM E/R if the verification results are OK.
5. IPDM E/R turns the steering lock relay ON and supplies power supply to the steering lock unit.
6. The steering lock releases.
7. BCM transmits the power supply stop signal to IPDM E/R when detecting that the steering lock is in the unlock condition.
8. IPDM E/R turns the steering lock relay OFF and stops power supply to the steering lock unit.
9. BCM turns ACC relay ON and transmits the ignition power supply ON signal to IPDM E/R.
10. IPDM E/R turns the ignition relay ON and starts the ignition power supply.
11. BCM detects that the selector lever position and brake pedal operating condition (A/T models) or shift lever position and clutch pedal operation condition (M/T models).
12. BCM transmits the starter request signal via CAN communication to IPDM E/R and turns the starter relay in IPDM E/R ON if BCM judges that the engine start condition is satisfied.
13. IPDM E/R turns the starter control relay ON when receiving the starter request signal.
14. Power supply is supplied through the starter relay and the starter control relay to operate the starter motor and start cranking.

CAUTION:

If a malfunction is detected in the Intelligent Key system, the "KEY" warning lamp in the combination meter illuminates. At that time, the engine cannot be started.

15. When BCM receives feedback signal from ECM indicating that the engine is started, the BCM transmits a stop signal to IPDM E/R and stops cranking by turning OFF the starter motor relay. (If engine start is unsuccessful, cranking stops automatically within 5 seconds.)

CAUTION:

When the Intelligent Key is carried outside of the vehicle (inside key antenna detection area) while the power supply is in the ACC or ON position, even if the engine start condition* is satisfied, the engine cannot be started.

*: For the engine start condition, refer to "PUSH-BUTTON IGNITION SWITCH OPERATION PROCEDURE".

Models without steering lock unit

1. When the push-button ignition switch is pressed, the BCM activates the inside key antenna and transmits the request signal to the Intelligent Key.
2. The Intelligent Key receives the request signal and transmits the Intelligent Key ID signal to the BCM via the remote keyless entry receiver.
3. The Intelligent Key receives the Intelligent Key ID signal and verifies it with the registered ID.
4. BCM turns ACC relay ON and transmits the ignition power supply ON signal to IPDM E/R.
5. IPDM E/R turns the ignition relay ON and starts the ignition power supply.

INTELLIGENT KEY SYSTEM/ENGINE START FUNCTION

< SYSTEM DESCRIPTION >

6. BCM detects that the selector lever position and brake pedal operating condition (A/T models) or shift lever position and clutch pedal operation condition (M/T models). A
7. BCM transmits the starter request signal via CAN communication to IPDM E/R and turns the starter relay in IPDM E/R ON if BCM judges that the engine start condition is satisfied. B
8. IPDM E/R turns the starter control relay ON when receiving the starter request signal. C
9. Power supply is supplied through the starter relay and the starter control relay to operate the starter motor and start cranking. D

CAUTION:

If a malfunction is detected in the Intelligent Key system, the “KEY” warning lamp in the combination meter illuminates. At that time, the engine cannot be started.

10. When BCM receives feedback signal from ECM indicating that the engine is started, the BCM transmits a stop signal to IPDM E/R and stops cranking by turning OFF the starter motor relay. (If engine start is unsuccessful, cranking stops automatically within 5 seconds.) E

CAUTION:

When the Intelligent Key is carried outside of the vehicle (inside key antenna detection area) while the power supply is in the ACC or ON position, even if the engine start condition* is satisfied, the engine cannot be started.

*: For the engine start condition, refer to “PUSH-BUTTON IGNITION SWITCH OPERATION PROCEDURE”. F

OPERATION RANGE

Engine can be started when Intelligent Key is inside the vehicle. However, sometimes engine may not start when Intelligent Key is on instrument panel or in glove box. G

OPERATION WHEN KEY SLOT IS USED

When the Intelligent Key battery is discharged, it performs IVIS (NATS) ID verification between the integrated transponder and BCM by inserting the Intelligent Key into the key slot, and then the engine can be started. H

For details relating to starting the engine using key slot, refer to [SEC-16, "System Description"](#).

BATTERY SAVER SYSTEM

When all the following conditions are met for 60 minutes, the battery saver system cuts off the power supply to prevent battery discharge. I

- The ignition switch is in the ACC position
- All doors are closed
- Selector lever is in the P position J

Reset Condition of Battery Saver System

A/T models

In order to prevent the battery from discharging, the battery saver system cuts off the power supply when all doors are closed, the selector lever is in the P position, and the ignition switch is left in the ACC position for 60 minutes. If any of the following conditions are met the battery saver system is released and the steering changes automatically to the LOCK position from the OFF position (Models with steering lock unit). L

- Opening any door
- Operating door lock using door request switch
- Operating door lock using Intelligent Key M

Press push-button ignition switch and ignition switch changes to the ACC position from the OFF position.

M/T models

If any of the above conditions are met, the battery saver system is released but the steering is not lock. In this case, the steering operation OFF to LOCK is prohibited. N

STEERING LOCK OPERATION (MODELS WITH STEERING LOCK UNIT)

Steering is locked by steering lock unit when ignition switch is in the OFF position, selector lever is in the P position, and any of the following conditions are met. O

- Opening door
- Closing door
- Door is locked using door request switch
- Door is locked using Intelligent Key P

NOTE:

For models without steering lock unit, power supply position changes to LOCK even though the steering lock operation is not performed.

POWER SUPPLY POSITION CHANGE TABLE BY PUSH-BUTTON IGNITION SWITCH OPERATION

INTELLIGENT KEY SYSTEM/ENGINE START FUNCTION

< SYSTEM DESCRIPTION >

The power supply position changing operation can be performed with the following operations.

NOTE:

- When an Intelligent Key is within the detection area of inside key antenna and when it is inserted to the key slot, it is equivalent to the operations below.
- When starting the engine, the BCM monitors under the engine start conditions,

A/T models

- Brake pedal operating condition
- Selector lever position
- Vehicle speed

M/T models

- Clutch pedal operating condition
- Vehicle speed

Vehicle speed: less than 4 km/h (2.5 MPH)

Power supply position	Engine start/stop condition			Push-button ignition switch operation frequency
	A/T models		M/T models	
	Selector lever position	Brake pedal operation condition	Clutch pedal operation condition	
LOCK → ACC	—	Not depressed	Not depressed	1
LOCK → ACC → ON	—	Not depressed	Not depressed	2
LOCK → ACC → ON → OFF	—	Not depressed	Not depressed	3
LOCK → START ACC → START ON → START	P or N position	Depressed	Depressed	1
Engine is running → OFF	—	—	—	1

Vehicle speed: 4 km/h (2.5 MPH) or more

Power supply position	Engine start/stop condition			Push-button ignition switch operation frequency
	A/T models		M/T models	
	Selector lever position	Brake pedal operation condition	Clutch pedal operation condition	
Engine is running → ACC	—	—	—	Emergency stop operation
Engine stall return operation while driving	N position	Not depressed	Depressed	1

Emergency stop operation

- Press and hold the push-button ignition switch for 2 seconds or more.
- Press the push-button ignition switch 3 times or more within 1.5 seconds.

INTELLIGENT KEY SYSTEM/ENGINE START FUNCTION

< SYSTEM DESCRIPTION >

Component Parts Location

INFOID:000000006471866

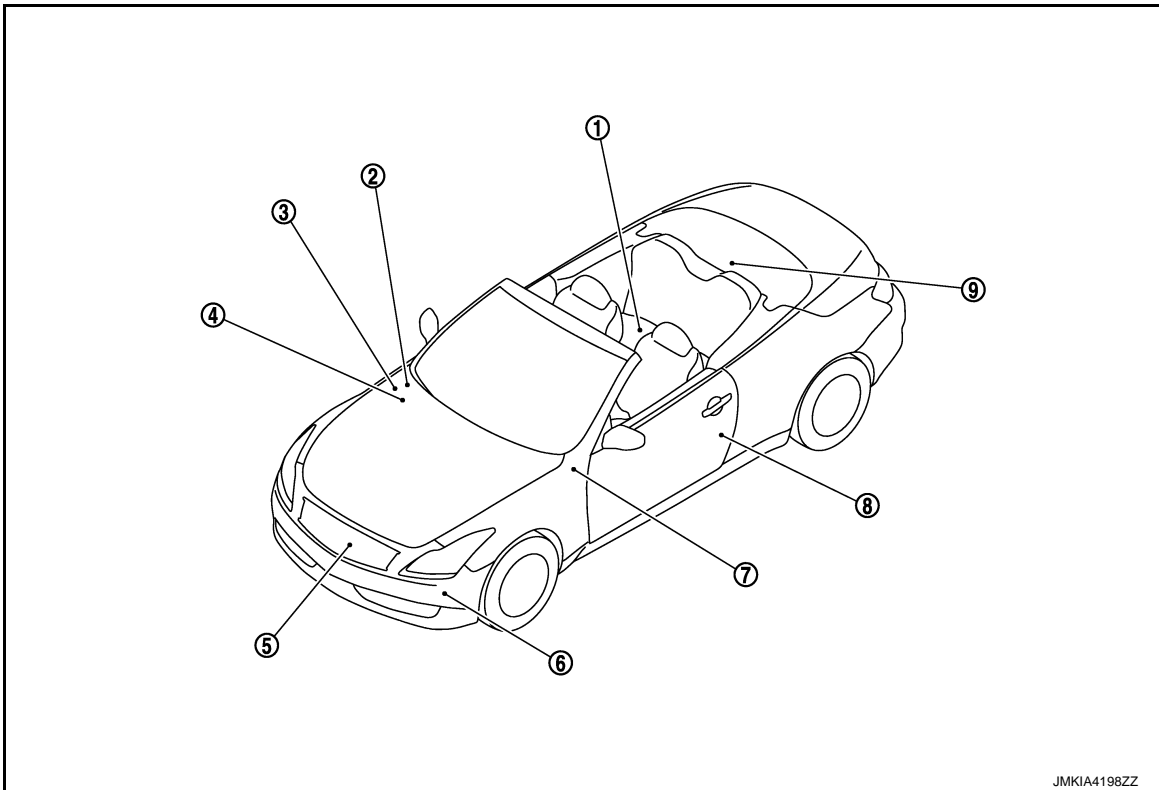

- | | | |
|--------------------------------------|---------------------------------------|----------------------------------------|
| 1. Inside key antenna (console) M146 | 2. Remote keyless entry receiver M104 | 3. IPDM E/R E5, E6, E7, E9, |
| 4. BCM M118, M119, M121, M122, M123 | 5. Horn (low) E67, E70 | 6. Horn (high) E61, E62 |
| 7. Key slot M22 | 8. Driver side door switch B16 | 9. Inside key antenna (trunk room) B49 |

A
B
C
D
E
F
G
H
I
J
L
M
N
O
P

SEC

INTELLIGENT KEY SYSTEM/ENGINE START FUNCTION

< SYSTEM DESCRIPTION >

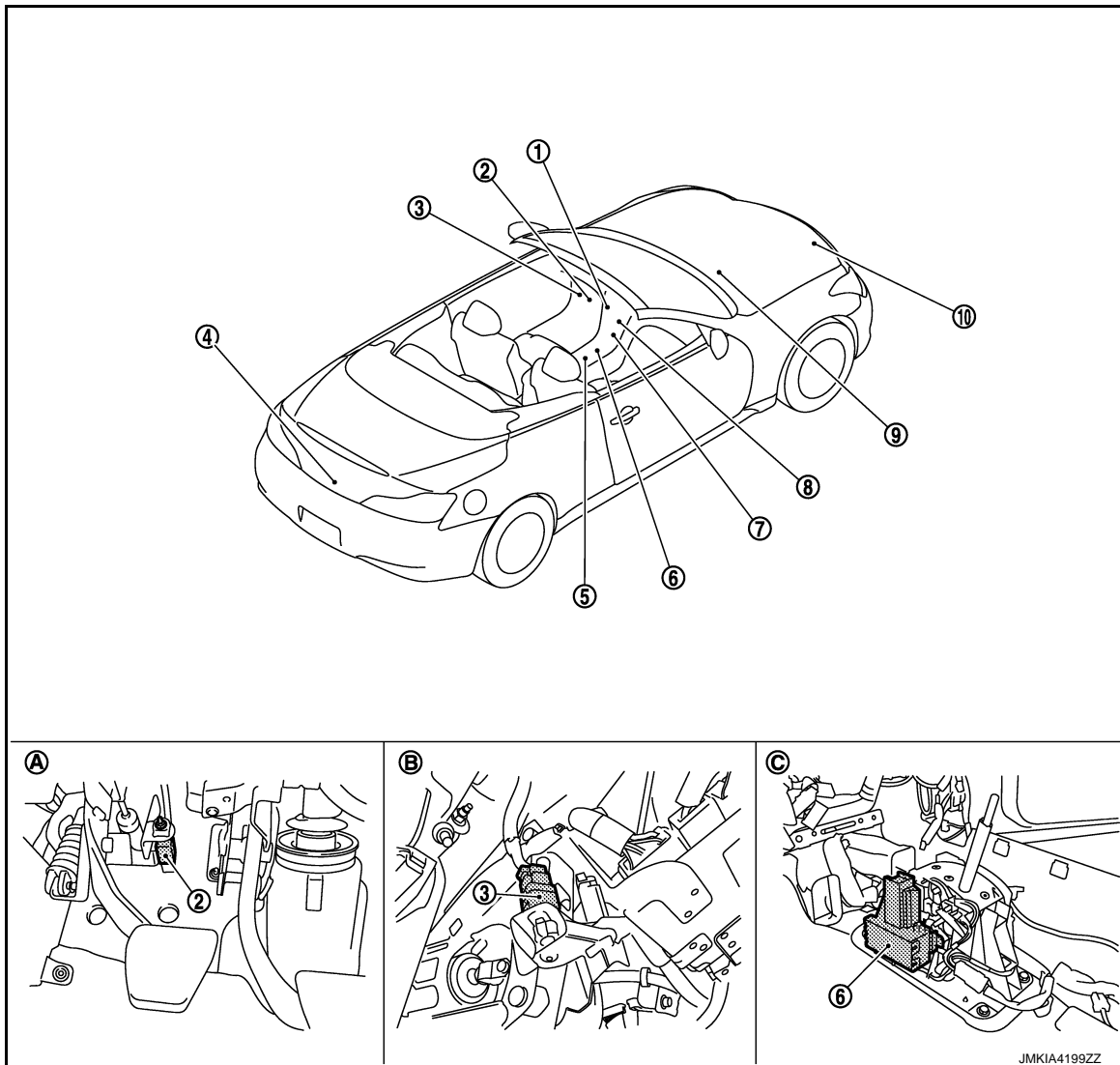

- | | | |
|-----------------------------------------------------|-----------------------------------------------------|------------------------------------------------------------|
| 1. Push-button ignition switch M50 | 2. Stop lamp switch E110 | 3. Clutch interlock switch E111 (M/T models) |
| 4. Trunk room lamp switch B306 | 5. TCM F157 (A/T models) | 6. A/T shift selector (detention switch) M137 (A/T models) |
| 7. Inside key antenna (instrument center) M131 | 8. Unified meter and A/C amp. M66, M67 | 9. ECM M107 |
| A. View with instrument driver lower cover removed. | B. View with instrument driver lower cover removed. | C. View with center console assembly removed |

Component Description

INFOID:000000006471867

Component	Reference
BCM	SEC-94
Steering lock unit (Models with steering lock unit)	SEC-80
Push-button ignition switch	SEC-55
Door switch	DLK-71
A/T shift selector (detention switch) (A/T models)	SEC-67
Inside key antenna	DLK-62
Remote keyless entry receiver	DLK-89

INTELLIGENT KEY SYSTEM/ENGINE START FUNCTION

< SYSTEM DESCRIPTION >

Component	Reference	
Stop lamp switch	SEC-53	A
TCM (A/T models)	SEC-59	
Clutch interlock switch (M/T models)	SEC-84	B
Steering lock relay (Models with steering lock unit)	SEC-71	
Starter relay	SEC-74	
Starter control relay	SEC-58	C
Security indicator lamp	SEC-118	
Key warning lamp	DLK-116	D

E

F

G

H

I

J

SEC

L

M

N

O

P

INFINITI VEHICLE IMMOBILIZER SYSTEM-NATS

< SYSTEM DESCRIPTION >

- Possible symptom of IVIS (NATS) malfunction is “Engine cannot start”. The engine can be started with the Intelligent Key system and IVIS (NATS). Identify the possible causes according to “Work Flow”. Refer to [SEC-5, "Work Flow"](#).
- If ECM other than genuine part is installed, the engine cannot be started. For ECM replacement procedure, refer to [EC-17, "ADDITIONAL SERVICE WHEN REPLACING CONTROL UNIT \(ECM\) : Special Repair Requirement"](#).

PRECAUTIONS FOR KEY REGISTRATION

- The key registration is a procedure that erases the current IVIS (NATS) ID once, and then reregisters a new ID operation. Therefore a registered Intelligent Key is necessary for this procedure. Before starting the registration operation collect all registered Intelligent Keys from the customer.
- When registering the Intelligent Key, perform only one procedure to simultaneously register both ID (IVIS “NATS” ID and Intelligent Key ID).
The IVIS (NATS) ID registration is the procedure that registers the ID stored into the transponder (integrated in Intelligent Key) to BCM.
The Intelligent key ID registration is the procedure that registers the ID to BCM.
- When performing the Intelligent Key system registration only, the engine cannot be started by inserting the key into the key slot. When performing the IVIS (NATS) registration only, the engine cannot be started by the operation when carrying the key. The registrations of both systems should be performed.

SECURITY INDICATOR LAMP

- Warns that the vehicle is equipped with IVIS (NATS).
- Security indicator lamp always blinks when the ignition switch is in the except ON position.

NOTE:

Because security indicator lamp is highly efficient, the battery is barely affected.

Component Parts Location

INFOID:000000006956351

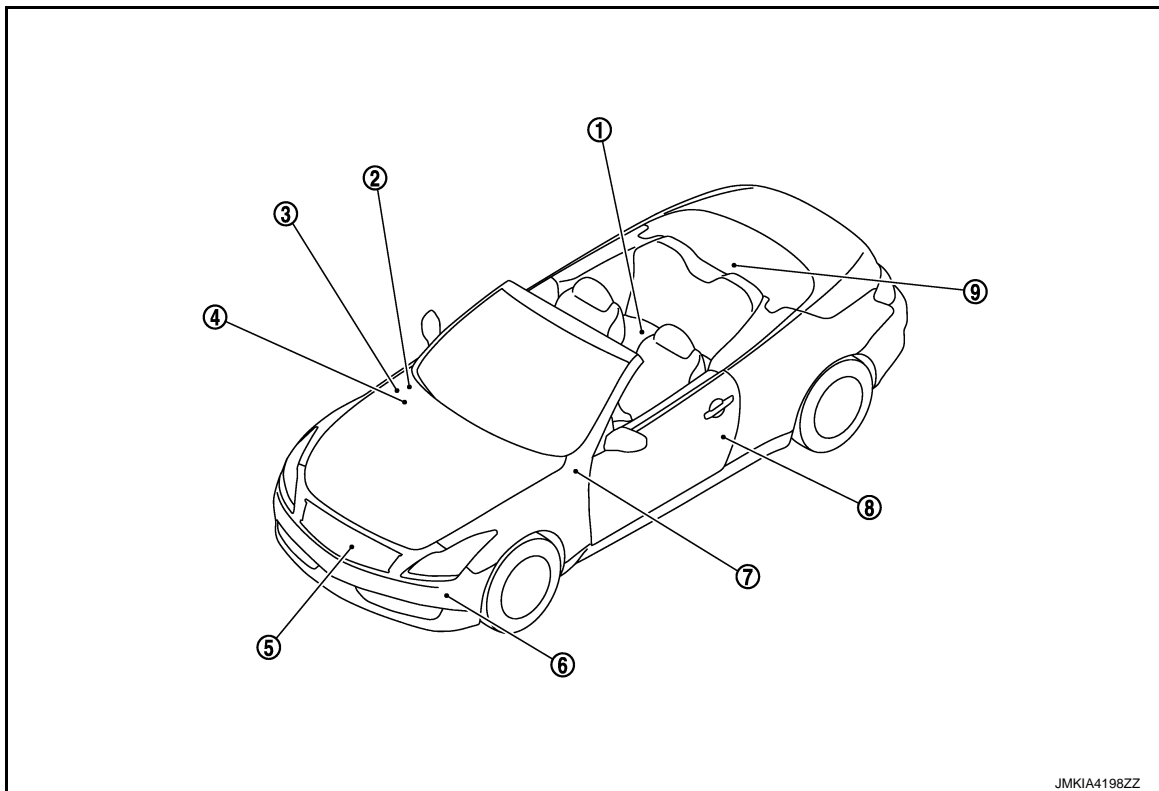

- | | | |
|--------------------------------------|---------------------------------------|----------------------------------------|
| 1. Inside key antenna (console) M146 | 2. Remote keyless entry receiver M104 | 3. IPDM E/R E5, E6, E7, E9, |
| 4. BCM M118, M119, M121, M122, M123 | 5. Horn (low) E67, E70 | 6. Horn (high) E61, E62 |
| 7. Key slot M22 | 8. Driver side door switch B16 | 9. Inside key antenna (trunk room) B49 |

INFINITI VEHICLE IMMOBILIZER SYSTEM-NATS

< SYSTEM DESCRIPTION >

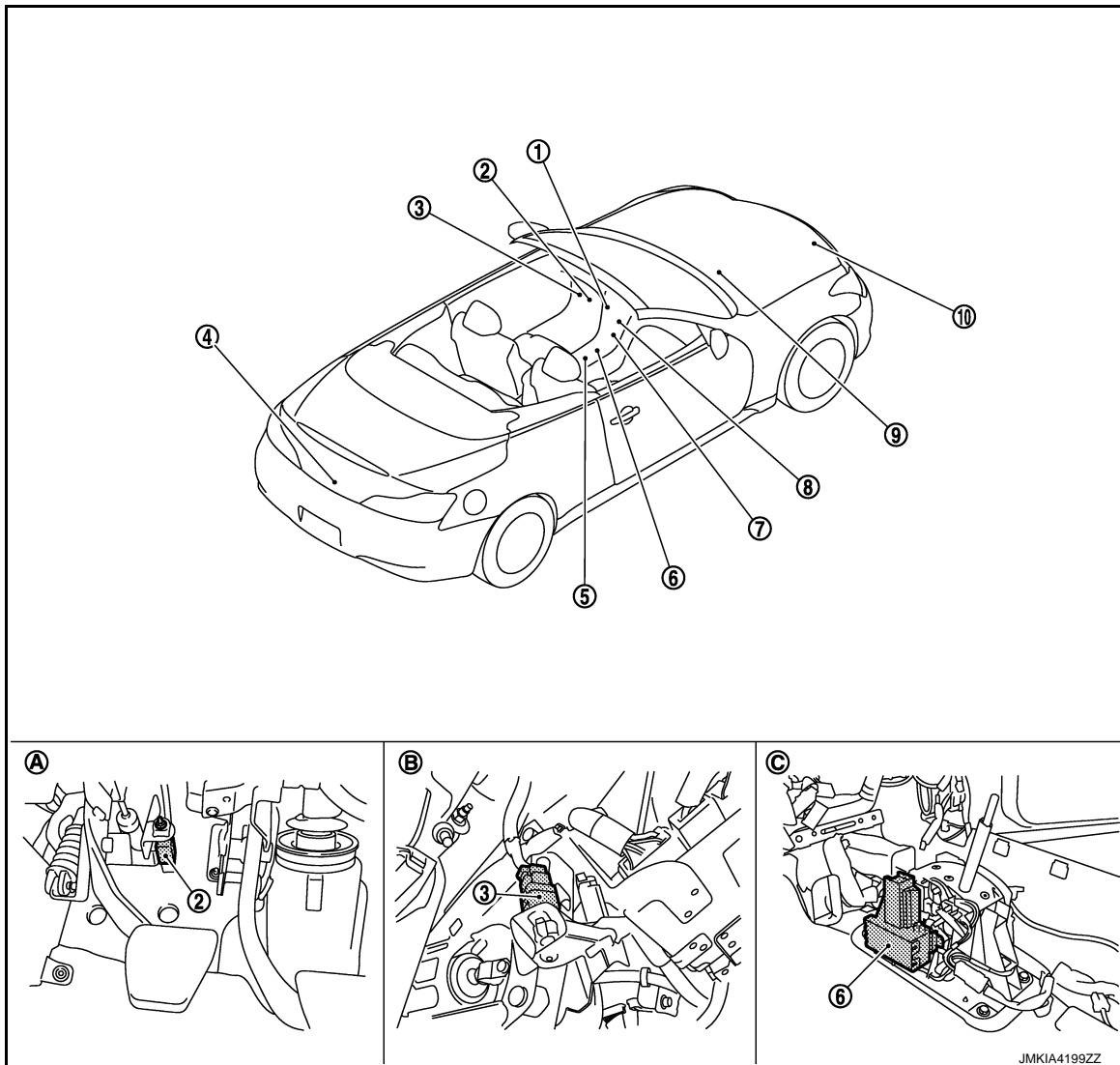

- | | | |
|-----------------------------------------------------|-----------------------------------------------------|------------------------------------------------------------|
| 1. Push-button ignition switch M50 | 2. Stop lamp switch E110 | 3. Clutch interlock switch E111 (M/T models) |
| 4. Trunk room lamp switch B306 | 5. TCM F157 (A/T models) | 6. A/T shift selector (detention switch) M137 (A/T models) |
| 7. Inside key antenna (instrument center) M131 | 8. Unified meter and A/C amp. M66,M67 | 9. ECM M107 |
| A. View with instrument driver lower cover removed. | B. View with instrument driver lower cover removed. | C. View with center console assembly removed |

Component Description

INFOID:000000006471871

Component	Reference
BCM	SEC-94
Steering lock unit (Models with steering lock unit)	SEC-80
Push-button ignition switch	SEC-55
Door switch	DLK-71
Key slot	DLK-110
A/T shift selector (detention switch) (A/T models)	SEC-67
Stop lamp switch	SEC-53

INFINITI VEHICLE IMMOBILIZER SYSTEM-NATS

< SYSTEM DESCRIPTION >

Component	Reference	
TCM (A/T models)	SEC-59	A
Clutch interlock switch (M/T models)	SEC-84	
Steering lock relay (Models with steering lock unit)	SEC-71	B
Starter relay	SEC-74	
Starter control relay	SEC-58	
Security indicator lamp	SEC-118	C

D

E

F

G

H

I

J

SEC

L

M

N

O

P

VEHICLE SECURITY SYSTEM

< SYSTEM DESCRIPTION >

VEHICLE SECURITY SYSTEM

System Diagram

INFOID:000000006471872

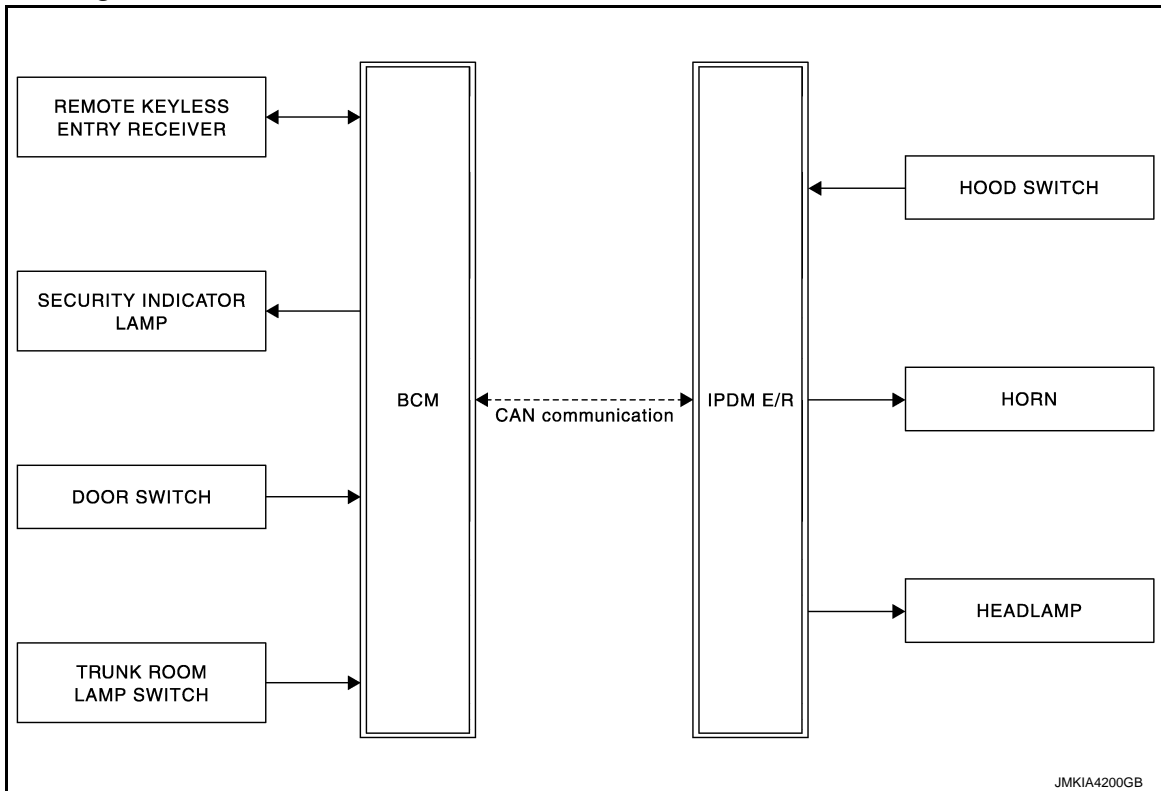

JMKIA4200GB

System Description

INFOID:000000006471873

OPERATION FLOW

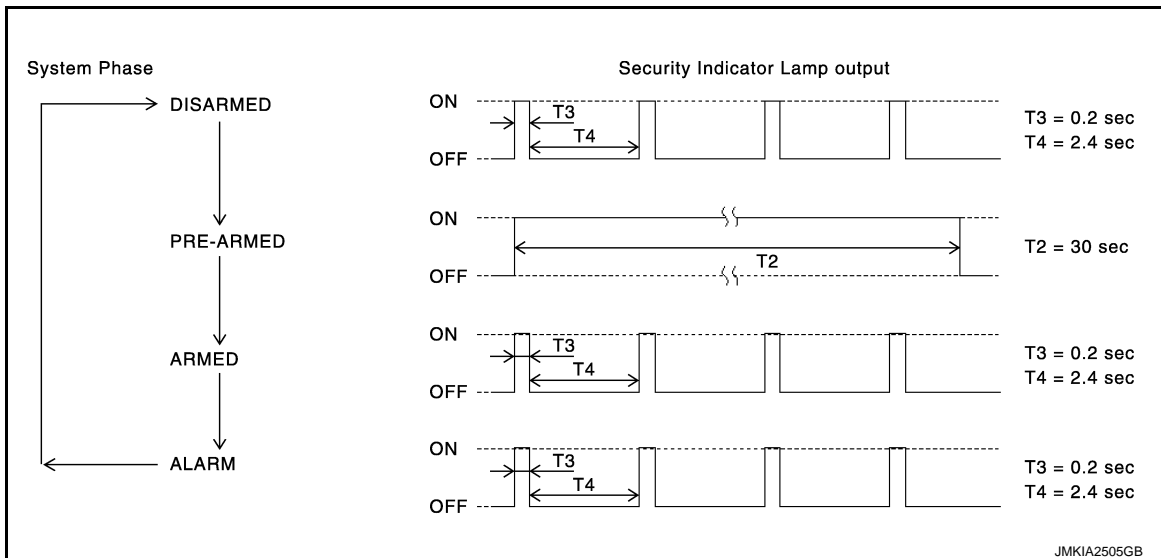

JMKIA2505GB

SETTING THE VEHICLE SECURITY SYSTEM

Initial Condition

Ignition switch is in OFF position.

Disarmed Phase

- When any door or trunk lid is open, the vehicle security system is set in the disarmed phase on the assumption that the owner is inside or near the vehicle.

VEHICLE SECURITY SYSTEM

< SYSTEM DESCRIPTION >

- When the vehicle security system is in the disarmed phase, the security indicator lamp blinks every 2.4 seconds.

Pre-armed Phase and Armed Phase

When the following operation 1 or 2 is performed, the vehicle security system turns into the “pre-armed” phase. (Security indicator lamp illuminates.)

1. BCM receives LOCK signal from door lock and unlock switch, door key cylinder switch door request switch or Intelligent Key, after all doors are closed.
2. All doors are closed after all doors are locked by mechanical key or door lock and unlock switch.

CANCELING THE ARMED PHASE VEHICLE SECURITY SYSTEM

When one of the following operations is performed, the armed phase is canceled.

1. Unlock all doors with the door lock and unlock switch, door key cylinder switch, door request switch or Intelligent Key.
2. Turn ignition switch “ON” or “ACC” position.

CANCELING THE ALARM OPERATION OF THE VEHICLE SECURITY SYSTEM

When on of the following operations is performed, the alarm operation is canceled.

1. Unlock all doors with the door request switch or Intelligent Key.
2. Turn ignition switch “ON” or “ACC” position.

ACTIVATING THE ALARM OPERATION OF THE VEHICLE SECURITY SYSTEM

Check that the system is in the armed phase. (Security indicator lamp blinks every 2.4 seconds.)

When the following operation 1 or 2 is performed, the system sounds the horns and blinks the headlamps for about 50 seconds.

1. Trunk lid, any door or hood is opened during armed phase.
2. Disconnecting and connecting the battery connector before canceling armed phase.

PANIC ALARM OPERATION

When BCM receives panic alarm signal from Intelligent Key, ground is supplied intermittently to both headlamp relay and horn relay.

When headlamp relay and horn relay are energized, then power is supplied to headlamps (HI) and horns (high, low).

The headlamps flash and the horn sounds intermittently.

The alarm automatically turns off after 50 seconds or when BCM receives any signal from Intelligent Key or door request switch.

A
B
C
D
E
F
G
H
I
J
L
M
N
O
P

SEC

VEHICLE SECURITY SYSTEM

< SYSTEM DESCRIPTION >

Component Parts Location

INFOID:000000006956352

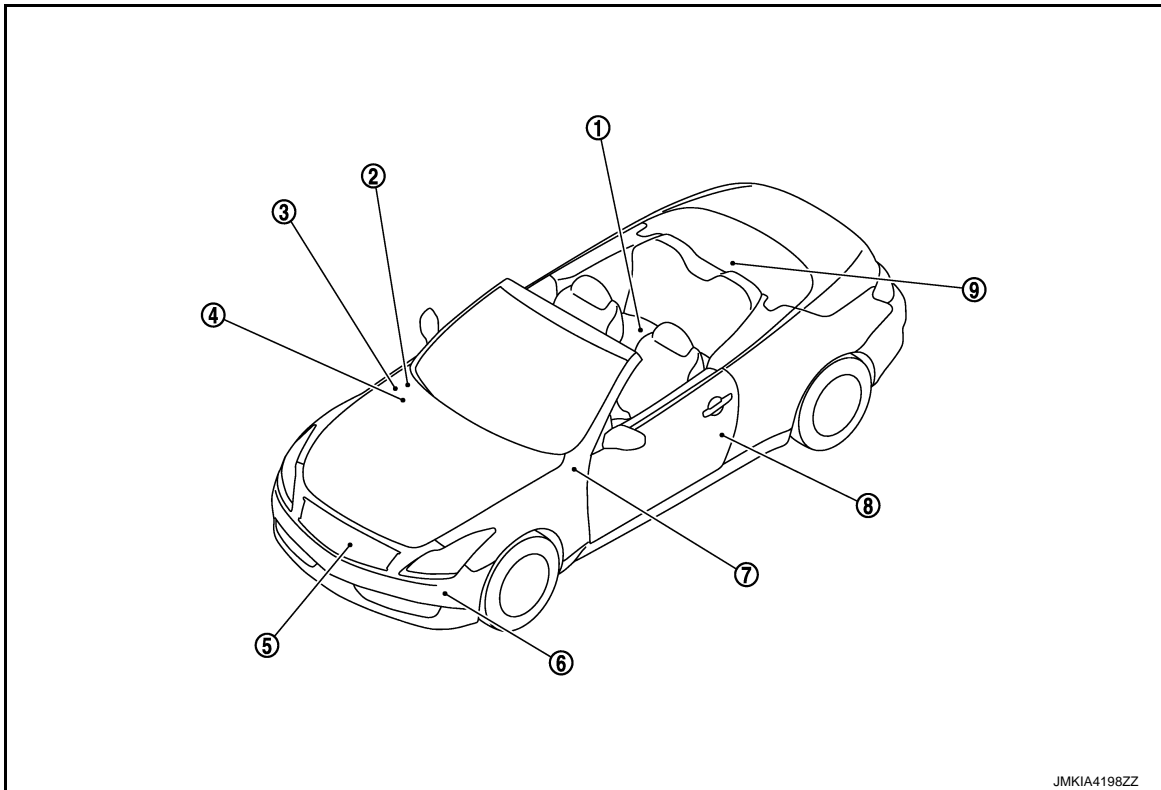

- | | | |
|--------------------------------------|---------------------------------------|----------------------------------------|
| 1. Inside key antenna (console) M146 | 2. Remote keyless entry receiver M104 | 3. IPDM E/R E5, E6, E7, E9, |
| 4. BCM M118, M119, M121, M122, M123 | 5. Horn (low) E67, E70 | 6. Horn (high) E61, E62 |
| 7. Key slot M22 | 8. Driver side door switch B16 | 9. Inside key antenna (trunk room) B49 |

VEHICLE SECURITY SYSTEM

< SYSTEM DESCRIPTION >

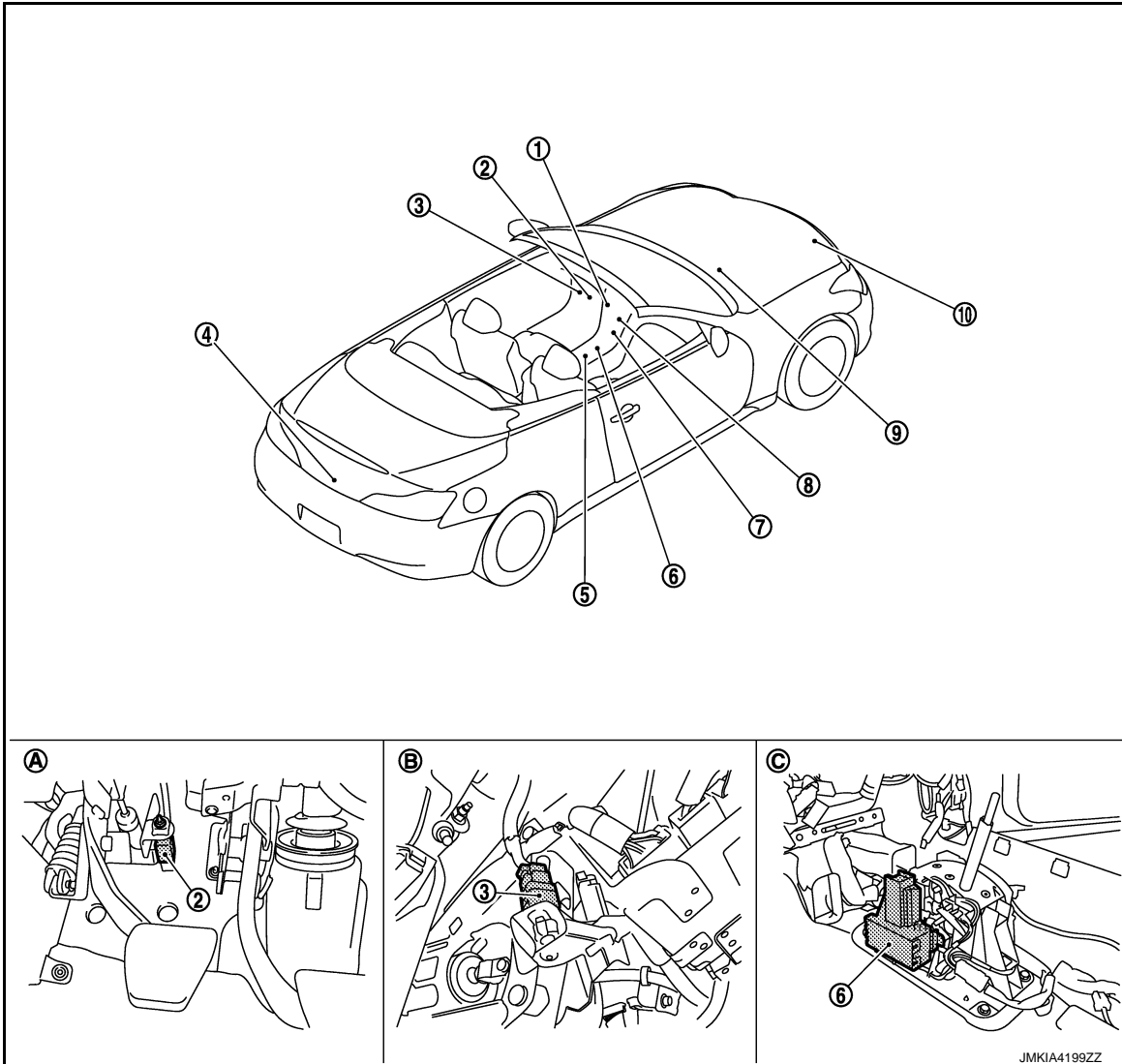

- | | | |
|-----------------------------------------------------|-----------------------------------------------------|------------------------------------------------------------|
| 1. Push-button ignition switch M50 | 2. Stop lamp switch E110 | 3. Clutch interlock switch E111 (M/T models) |
| 4. Trunk room lamp switch B306 | 5. TCM F157 (A/T models) | 6. A/T shift selector (detention switch) M137 (A/T models) |
| 7. Inside key antenna (instrument center) M131 | 8. Unified meter and A/C amp. M66, M67 | 9. ECM M107 |
| A. View with instrument driver lower cover removed. | B. View with instrument driver lower cover removed. | C. View with center console assembly removed |

Component Description

INFOID:000000006471875

Component	Reference
BCM	SEC-94
Security indicator lamp	SEC-118
Door switch	DLK-71
Trunk room lamp switch	DLK-82
Hood switch	SEC-116

A
B
C
D
E
F
G
H
I
J
K
L
M
N
O
P

SEC

DIAGNOSIS SYSTEM (BCM)

< SYSTEM DESCRIPTION >

DIAGNOSIS SYSTEM (BCM)

COMMON ITEM

COMMON ITEM : CONSULT-III Function (BCM - COMMON ITEM)

INFOID:000000006956343

APPLICATION ITEM

CONSULT-III performs the following functions via CAN communication with BCM.

Diagnosis mode	Function Description
Work Support	Changes the setting for each system function.
Self Diagnostic Result	Displays the diagnosis results judged by BCM.
CAN Diag Support Monitor	Monitors the reception status of CAN communication viewed from BCM. Refer to CONSULT-III operation manual.
Data Monitor	The BCM input/output signals are displayed.
Active Test	The signals used to activate each device are forcibly supplied from BCM.
Ecu Identification	The BCM part number is displayed.
Configuration	This function is not used even though it is displayed.

SYSTEM APPLICATION

BCM can perform the following functions for each system.

NOTE:

It can perform the diagnosis modes except the following for all sub system selection items.

×: Applicable item

System	Sub system selection item	Diagnosis mode		
		Work Support	Data Monitor	Active Test
Door lock	DOOR LOCK	×	×	×
Rear window defogger	REAR DEFOGGER		×	×
Warning chime	BUZZER		×	×
Interior room lamp timer	INT LAMP	×	×	×
—	MULTI REMOTE ENT*1			
Exterior lamp	HEAD LAMP	×	×	×
Wiper and washer	WIPER	×*2	×	×
Turn signal and hazard warning lamps	FLASHER	×	×	×
—	AIR CONDITONER*1			
• Intelligent Key system • Engine start system	INTELLIGENT KEY	×	×	×
Combination switch	COMB SW		×	
Body control system	BCM	×		
IVIS - NATS	IMMU		×	×
Interior room lamp battery saver	BATTERY SAVER	×	×	×
Trunk lid open	TRUNK		×	×
Vehicle security system	THEFT ALM	×	×	×
RAP system	RETAINED PWR		×	
Signal buffer system	SIGNAL BUFFER		×	×
TPMS	TPMS (AIR PRESSURE MONITOR)	×	×	×

NOTE:

- *1: This item is displayed, but is not used.
- *2: At models with rain sensor this mode is displayed, but is not used.

FREEZE FRAME DATA (FFD)

DIAGNOSIS SYSTEM (BCM)

< SYSTEM DESCRIPTION >

The BCM records the following vehicle condition at the time a particular DTC is detected, and displays on CONSULT-III.

CONSULT screen item	Indication/Unit	Description
Vehicle Speed	km/h	Vehicle speed of the moment a particular DTC is detected
Odo/Trip Meter	km	Total mileage (Odometer value) of the moment a particular DTC is detected
Vehicle Condition	SLEEP>LOCK	While turning BCM status from low power consumption mode to normal mode (Power supply position is "LOCK"*)
	SLEEP>OFF	While turning BCM status from low power consumption mode to normal mode (Power supply position is "OFF".)
	LOCK>ACC	While turning power supply position from "LOCK"* to "ACC"
	ACC>ON	While turning power supply position from "ACC" to "IGN"
	RUN>ACC	While turning power supply position from "RUN" to "ACC" (Except emergency stop operation)
	CRANK>RUN	While turning power supply position from "CRANKING" to "RUN" (From cranking up the engine to run it)
	RUN>URGENT	While turning power supply position from "RUN" to "ACC" (Emergency stop operation)
	ACC>OFF	While turning power supply position from "ACC" to "OFF"
	OFF>LOCK	While turning power supply position from "OFF" to "LOCK"*
	OFF>ACC	While turning power supply position from "OFF" to "ACC"
	ON>CRANK	While turning power supply position from "IGN" to "CRANKING"
	OFF>SLEEP	While turning BCM status from normal mode (Power supply position is "OFF".) to low power consumption mode
	LOCK>SLEEP	While turning BCM status from normal mode (Power supply position is "LOCK"*.) to low power consumption mode
	LOCK	Power supply position is "LOCK" (Ignition switch OFF with steering is locked.)*
	OFF	Power supply position is "OFF" (Ignition switch OFF with steering is unlocked.)
	ACC	Power supply position is "ACC" (Ignition switch ACC)
	ON	Power supply position is "IGN" (Ignition switch ON with engine stopped)
ENGINE RUN	Power supply position is "RUN" (Ignition switch ON with engine running)	
CRANKING	Power supply position is "CRANKING" (At engine cranking)	
IGN Counter	0 - 39	<p>The number of times that ignition switch is turned ON after DTC is detected</p> <ul style="list-style-type: none"> • The number is 0 when a malfunction is detected now. • The number increases like 1 → 2 → 3...38 → 39 after returning to the normal condition whenever ignition switch OFF → ON. • The number is fixed to 39 until the self-diagnosis results are erased if it is over 39.

NOTE:

*: For models without steering lock unit, power supply position changes from "OFF" to "LOCK" when steering lock conditions are satisfied.

INTELLIGENT KEY

INTELLIGENT KEY : CONSULT-III Function (BCM - INTELLIGENT KEY)

INFOID:000000006956485

WORK SUPPORT

DIAGNOSIS SYSTEM (BCM)

< SYSTEM DESCRIPTION >

Monitor item	Description
CONFIRM KEY FOB ID	It can be checked whether Intelligent Key ID code is registered or not in this mode
AUTO LOCK SET	Auto door lock time can be changed in this mode <ul style="list-style-type: none"> • MODE 1: 1 minute • MODE 2: 5 minutes • MODE 3: 30 seconds • MODE 4: 2 minutes
LOCK/UNLOCK BY I-KEY	Door lock/unlock function by door request switch (driver side and passenger side) mode can be changed to operate (ON) or not operate (OFF) in this mode
ENGINE START BY I-KEY	Engine start function mode can be changed to operate (ON) or not operate (OFF) with this mode
TRUNK/GLASS HATCH OPEN	Buzzer reminder function mode by trunk lid opener request switch can be changed to operate (ON) or not operate (OFF) with this mode
PANIC ALARM SET	Panic alarm button pressing time on Intelligent Key remote control button can be selected from the following with this mode <ul style="list-style-type: none"> • MODE 1: 0.5 sec • MODE 2: Non-operation • MODE 3: 1.5 sec
PW DOWN SET	Unlock button pressing time on Intelligent Key button can be selected from the following with this mode <ul style="list-style-type: none"> • MODE 1: 3 sec • MODE 2: Non-operation • MODE 3: 5 sec
TRUNK OPEN DELAY	Trunk button pressing on Intelligent Key button can be selected as per the following in this mode <ul style="list-style-type: none"> • MODE 1: Press and hold • MODE 2: Press twice • MODE 3: Press and hold, or press twice
LO- BATT OF KEY FOB WARN	Intelligent Key low battery warning mode can be changed to operate (ON) or not operate (OFF) with this mode
ANTI KEY LOCK IN FUNCTI	Key reminder function mode can be changed to operate (ON) or not operate (OFF) with this mode
HAZARD ANSWER BACK	Hazard reminder function mode can be selected from the following with this mode <ul style="list-style-type: none"> • LOCK ONLY: Door lock operation only • UNLOCK ONLY: Door unlock operation only • LOCK/UNLOCK: Lock/unlock operation • OFF: Non-operation
ANS BACK I-KEY LOCK	Buzzer reminder function (lock operation) mode by door request switch (driver side and passenger side) can be selected from the following with this mode <ul style="list-style-type: none"> • Horn chirp: Sound horn • Buzzer: Sound Intelligent Key warning buzzer • OFF: Non-operation
ANS BACK I-KEY UNLOCK	Buzzer reminder function (unlock operation) mode by door request switch can be changed to operate (ON) or not operate (OFF) with this mode
SHORT CRANKING OUTPUT	Starter motor can operate during the times below <ul style="list-style-type: none"> • 70 msec • 100 msec • 200 msec
INSIDE ANT DIAGNOSIS	This function allows inside key antenna self-diagnosis
HORN WITH KEYLESS LOCK	Horn reminder function mode by Intelligent Key button can be changed to operate (ON) or not operate (OFF) with this mode

SELF-DIAG RESULT

Refer to [BCS-75, "DTC Index"](#).

DATA MONITOR

DIAGNOSIS SYSTEM (BCM)

< SYSTEM DESCRIPTION >

Monitor Item	Condition	
REQ SW -DR	Indicates [ON/OFF] condition of door request switch (driver side)	A
REQ SW -AS	Indicates [ON/OFF] condition of door request switch (passenger side)	
REQ SW -BD/TR	Indicates [ON/OFF] condition of trunk lid opener request switch	B
PUSH SW	Indicates [ON/OFF] condition of push-button ignition switch	
IGN RLY2 -F/B	Indicates [ON/OFF] condition of ignition relay 2	C
ACC RLY-FB	NOTE: This item is displayed, but cannot be monitored	
CLUTCH SW*1	Indicates [ON/OFF] condition of clutch switch	D
BRAKE SW 1	Indicates [ON/OFF]*3 condition of brake switch power supply	
BRAKE SW 2	Indicates [ON/OFF] condition of brake switch	E
DETE/CANCL SW*2	Indicates [ON/OFF] condition of P position	
SFT PN/N SW*2	Indicates [ON/OFF] condition of P or N position	
S/L -LOCK	Indicates [ON/OFF] condition of steering lock unit (LOCK) NOTE: For models without steering lock unit, this item is not monitored.	F
S/L -UNLOCK	Indicates [ON/OFF] condition of steering lock unit (UNLOCK) NOTE: For models without steering lock unit, this item is not monitored.	G
S/L RELAY -F/B	Indicates [ON/OFF] condition of steering lock relay NOTE: For models without steering lock unit, this item is not monitored.	H
UNLK SEN -DR	Indicates [ON/OFF] condition of driver door UNLOCK status	I
PUSH SW -IPDM	Indicates [ON/OFF] condition of push-button ignition switch	
IGN RLY1 -F/B	Indicates [ON/OFF] condition of ignition relay 1	J
DETE SW -IPDM*2	Indicates [ON/OFF] condition of P position	
SFT PN -IPDM*2	Indicates [ON/OFF] condition of P or N position	
SFT P -MET*2	Indicates [ON/OFF] condition of P position	SEC
SFT N -MET*2	Indicates [ON/OFF] condition of N position	
ENGINE STATE	Indicates [STOP/STALL/CRANK/RUN] condition of engine states	L
S/L LOCK-IPDM	Indicates [ON/OFF] condition of steering lock unit (LOCK) NOTE: For models without steering lock unit, this item is not monitored.	M
S/L UNLK-IPDM	Indicates [ON/OFF] condition of steering lock unit (UNLOCK) NOTE: For models without steering lock unit, this item is not monitored.	N
S/L RELAY-REQ	Indicates [ON/OFF] condition of steering lock relay NOTE: For models without steering lock unit, this item is not monitored.	O
VEH SPEED 1	Display the vehicle speed signal received from combination meter by numerical value [Km/h]	P
VEH SPEED 2	Display the vehicle speed signal received from ABS or VDC or TCM by numerical value [Km/h]	
DOOR STAT-DR	Indicates [LOCK/READY/UNLOCK] condition of driver side door status	
DOOR STAT-AS	Indicates [LOCK/READY/UNLOCK] condition of passenger side door status	
ID OK FLAG	Indicates [SET/RESET] condition of key ID	
PRMT ENG STRT	Indicates [SET/RESET] condition of engine start possibility	
PRMT RKE STRT	NOTE: This item is displayed, but cannot be monitored	
KEY SW -SLOT	Indicates [ON/OFF] condition of key slot	

DIAGNOSIS SYSTEM (BCM)

< SYSTEM DESCRIPTION >

Monitor Item	Condition
TRNK/HAT MNTR	Indicates [ON/OFF] condition of trunk lid
RKE-LOCK	Indicates [ON/OFF] condition of LOCK signal from Intelligent Key
RKE-UNLOCK	Indicates [ON/OFF] condition of UNLOCK signal from Intelligent Key
RKE-TR/BD	Indicates [ON/OFF] condition of TRUNK LID OPEN signal from Intelligent Key
RKE-PANIC	Indicates [ON/OFF] condition of PANIC button of Intelligent Key
RKE-P/W OPEN	Indicates [ON/OFF] condition of P/W DOWN signal from Intelligent Key
RKE-MODE CHG	Indicates [ON/OFF] condition of MODE CHANGE signal from Intelligent Key
RKE OPE COUN1	When remote keyless entry receiver receives the signal transmitted while operating on Intelligent Key, the numerical value start changing
RKE OPE COUN2	NOTE: This item is displayed, but cannot be monitored
REVERSE SW*1	Indicates [ON/OFF] condition of R position

*1: It is displayed but does not operate on A/T models.

*2: It is displayed but does not operate on M/T models.

*3: OFF is displayed when brake pedal is depressed while brake switch power supply is OFF.

ACTIVE TEST

Test item	Description
BATTERY SAVER	This test is able to check interior room lamp operation The interior room lamp is activated after "On" on CONSULT-III screen is touched
PW REMOTO DOWN SET	This test is able to check power window down operation The power window down is activated after "On" on CONSULT-III screen is touched
OUTSIDE BUZZER	This test is able to check Intelligent Key warning buzzer operation The Intelligent Key warning buzzer is activated after "On" on CONSULT-III screen is touched
INSIDE BUZZER	This test is able to check warning chime in combination meter operation <ul style="list-style-type: none"> • Take away warning chime sounds when "Take out" on CONSULT-III screen is touched • Key warning chime sounds when "Key" on CONSULT-III screen is touched • OFF position warning chime sounds when "Knob" on CONSULT-III screen is touched
INDICATOR	This test is able to check warning lamp operation <ul style="list-style-type: none"> • "KEY" Warning lamp illuminates when "KEY ON" on CONSULT-III screen is touched • "KEY" Warning lamp blinks when "KEY IND" on CONSULT-III screen is touched
INT LAMP	This test is able to check interior room lamp operation The interior room lamp is activated after "On" on CONSULT-III screen is touched
LCD	This test is able to check meter display information <ul style="list-style-type: none"> • Engine start information displays when "BP N" on CONSULT-III screen is touched • Engine start information displays when "BP I" on CONSULT-III screen is touched • Key ID warning displays when "ID NG" on CONSULT-III screen is touched • Steering lock information displays when "ROTAT" on CONSULT-III screen is touched <p>NOTE: For models without steering lock unit, "ROTAT" is displayed, but cannot be tasted.</p> <ul style="list-style-type: none"> • P position warning displays when "SFT P" on CONSULT-III screen is touched • Intelligent Key insert information displays when "INSRT" on CONSULT-III screen is touched • Intelligent Key low battery warning displays when "BATT" on CONSULT-III screen is touched • Take away through window warning displays when "NO KY" on CONSULT-III screen is touched • Take away warning display when "OUTKEY" on CONSULT-III screen is touched • OFF position warning display when "LK WN" on CONSULT-III screen is touched
TRUNK/GLASS HATCH	This test is able to check trunk lid opener actuator open operation This actuator opens when "Open" on CONSULT-III screen is touched
FLASHER	This test is able to check security hazard lamp operation The hazard lamps are activated after "LH/RH/Off" on CONSULT-III screen is touched

DIAGNOSIS SYSTEM (BCM)

< SYSTEM DESCRIPTION >

Test item	Description
HORN	This test is able to check horn operation The horn is activated after "On" on CONSULT-III screen is touched
P RANGE	This test is able to check control device power supply Control device power is supplied when "On" on CONSULT-III screen is touched
ENGINE SW ILLUMI	This test is able to check push-ignition switch illumination operation Push-ignition switch illumination illuminates when "On" on CONSULT-III screen is touched
LOCK INDICATOR	This test is able to check LOCK indicator in push-ignition switch operation LOCK indicator in push-ignition switch illuminates when "On" on CONSULT-III screen is touched
ACC INDICATOR	This test is able to check ACC indicator in push-ignition switch operation ACC indicator in push-ignition switch illuminates when "On" on CONSULT-III screen is touched
IGNITION ON IND	This test is able to check on indicator in push-ignition switch operation ON indicator in push-ignition switch illuminates when "On" on CONSULT-III screen is touched
KEY SLOT ILLUMI	This test is able to check key slot illumination operation Key slot illumination blinks when "On" on CONSULT-III screen is touched
TRUNK/BACK DOOR	This test is able to check trunk lid opener actuator open operation This actuator opens when "Open" on CONSULT-III screen is touched

THEFT ALM

THEFT ALM : CONSULT-III Function (BCM - THEFT)

INFOID:000000006471878

DATA MONITOR

Monitored Item	Description
REQ SW-DR	Indicates [ON/OFF] condition of door request switch (driver side).
REQ SW-AS	Indicates [ON/OFF] condition of door request switch (passenger side).
REQ SW-BD/TR	Indicates [ON/OFF] condition of trunk opener request switch.
PUSH SW	Indicates [ON/OFF] condition of push-button ignition switch
UNLK SEN-DR	Indicates [ON/OFF] condition of driver door UNLOCK status.
KEY SW -SLOT	Indicates [ON/OFF] condition of key slot.
DOOR SW-DR	Indicates [ON/OFF] condition of front door switch LH.
DOOR SW-AS	Indicates [ON/OFF] condition of front door switch RH.
DOOR SW-RR	Indicates [ON/OFF] condition of rear door switch RH.
DOOR SW-RL	Indicates [ON/OFF] condition of rear door switch LH.
DOOR SW-BK	This is displayed even when it is not equipped.
CDL LOCK SW	Indicates [ON/OFF] condition of lock signal from door lock/unlock switch LH and RH.
CDL UNLOCK SW	Indicates [ON/OFF] condition of unlock signal from door lock/unlock switch LH and RH.
KEY CYL LK-SW	Indicates [ON/OFF] condition of lock signal from front door key cylinder switch.
KEY CYL UN-SW	Indicates [ON/OFF] condition of unlock signal from front door key cylinder switch.
KEY CYL SW-TR	This is displayed even when it is not equipped.
TR/BD OPEN SW	Indicates [ON/OFF] condition of trunk lid opener switch.
TRNK/HAT MNTR	Indicates [ON/OFF] condition of trunk room lamp switch.
RKE-LOCK	Indicates [ON/OFF] condition of LOCK signal from Intelligent Key.
RKE-UNLOCK	Indicates [ON/OFF] condition of UNLOCK signal from Intelligent Key.
RKE-TR/BD	Indicates [ON/OFF] condition of TRUNK OPEN signal from Intelligent Key.

WORK SUPPORT

DIAGNOSIS SYSTEM (BCM)

< SYSTEM DESCRIPTION >

Test Item	Description
SECURITY ALARM SET	This mode is able to confirm and change security alarm ON-OFF setting.
THEFT ALM TRG	The switch which triggered vehicle security alarm is recorded. This mode is able to confirm and erase the record of vehicle security alarm. The trigger data can be erased by touching "CLEAR" on CONSULT-III screen.

ACTIVE TEST

Test Item	Description
THEFT IND	This test is able to check security indicator lamp operation. Security indicator lamp will be turned on when "ON" on CONSULT-III screen is touched.
VEHICLE SECURITY HORN	This test is able to check horn operation. Horns will be activated for 0.5 seconds after "ON" on CONSULT-III screen is touched.
HEADLAMP(HI)	This test is able to check headlamp operation. Headlamps will be activated for 0.5 seconds after "ON" on CONSULT-III screen is touched.
FLASHER	This test is able to check hazard warning lamp operation. Hazard warning lamps will be activated after "ON" on CONSULT-III screen is touched.

IMMU

IMMU : CONSULT-III Function (BCM - IMMU)

INFOID:000000006471879

DATA MONITOR

Monitor item	Content
CONFIRM ID ALL	Indicates [YET] at all time. Switch to [DONE] when a registered Intelligent Key is inserted into the key slot.
CONFIRM ID4	
CONFIRM ID3	
CONFIRM ID2	
CONFIRM ID1	
TP 4	Indicates the number of ID which has been registered.
TP 3	
TP 2	
TP 1	
PUSH SW	Indicates [ON/OFF] condition of push-button ignition switch.
KEY SW -SLOT	Indicates [ON/OFF] condition of key slot.

ACTIVE TEST

Test item	Description
THEFT IND	This test is able to check security indicator lamp operation. Security indicator lamp will be turned on when "ON" on CONSULT-III screen touched.

DIAGNOSIS SYSTEM (IPDM E/R)

< SYSTEM DESCRIPTION >

DIAGNOSIS SYSTEM (IPDM E/R)

CONSULT-III Function (IPDM E/R)

INFOID:000000006956319

APPLICATION ITEM

CONSULT-III performs the following functions via CAN communication with IPDM E/R.

Diagnosis mode	Description
Ecu Identification	Allows confirmation of IPDM E/R part number.
Self Diagnostic Result	Displays the diagnosis results judged by IPDM E/R.
Data Monitor	Displays the real-time input/output data from IPDM E/R input/output data.
Active Test	IPDM E/R can provide a drive signal to electronic components to check their operations.
CAN Diag Support Monitor	The results of transmit/receive diagnosis of CAN communication can be read.

SELF DIAGNOSTIC RESULT

Refer to [SEC-202. "DTC Index"](#).

DATA MONITOR

Monitor item

Monitor Item [Unit]	MAIN SIG- NALS	Description
RAD FAN REQ [%]	×	Displays the value of the cooling fan speed signal received from ECM via CAN communication.
AC COMP REQ [Off/On]	×	Displays the status of the A/C compressor request signal received from ECM via CAN communication.
TAIL&CLR REQ [Off/On]	×	Displays the status of the position light request signal received from BCM via CAN communication.
HL LO REQ [Off/On]	×	Displays the status of the low beam request signal received from BCM via CAN communication.
HL HI REQ [Off/On]	×	Displays the status of the high beam request signal received from BCM via CAN communication.
FR FOG REQ [Off/On]	×	Displays the status of the front fog light request signal received from BCM via CAN communication.
FR WIP REQ [Stop/1LOW/Low/Hi]	×	Displays the status of the front wiper request signal received from BCM via CAN communication.
WIP AUTO STOP [STOP P/ACT P]	×	Displays the status of the front wiper auto stop signal judged by IPDM E/R.
WIP PROT [Off/BLOCK]	×	Displays the status of the front wiper fail-safe operation judged by IPDM E/R.
IGN RLY1 -REQ [Off/On]		Displays the status of the ignition switch ON signal received from BCM via CAN communication.
IGN RLY [Off/On]	×	Displays the status of the ignition relay judged by IPDM E/R.
PUSH SW [Off/On]		Displays the status of the push-button ignition switch judged by IPDM E/R.
INTER/NP SW [Off/On]		Displays the status of the clutch interlock switch (M/T models) or shift position (A/T models) judged by IPDM E/R.
ST RLY CONT [Off/On]		Displays the status of the starter relay status signal received from BCM via CAN communication.
IHBT RLY -REQ [Off/On]		Displays the status of the starter control relay signal received from BCM via CAN communication.
ST/INHI RLY [Off/ ST ON/INHI ON/UNKWN]		Displays the status of the starter relay and starter control relay judged by IPDM E/R.

DIAGNOSIS SYSTEM (IPDM E/R)

< SYSTEM DESCRIPTION >

Monitor Item [Unit]	MAIN SIG- NALS	Description
DETENT SW [Off/On]		Displays the status of the A/T shift selector (detention switch) judged by IPDM E/R.
S/L RLY -REQ [Off/On]		Displays the status of the steering lock relay request received from BCM via CAN communication. NOTE: For models without steering lock unit, this item is not monitored.
S/L STATE [LOCK/UNLOCK/UNKWN]		Displays the status of the steering lock judged by IPDM E/R. NOTE: For models without steering lock unit, this item is not monitored.
DTRL REQ [Off/On]		NOTE: The item is indicated, but not monitored.
OIL P SW [Open/Close]		Displays the status of the oil pressure switch judged by IPDM E/R.
HOOD SW [Off/On]		Displays the status of the hood switch judged by IPDM E/R.
HL WASHER REQ [Off/On]		NOTE: The item is indicated, but not monitored.
THFT HRN REQ [Off/On]		Displays the status of the theft warning horn request signal received from BCM via CAN communication.
HORN CHIRP [Off/On]		Displays the status of the horn reminder signal received from BCM via CAN communication.
CRNRNG LMP REQ [Off/On]		NOTE: The item is indicated, but not monitored.

ACTIVE TEST

Test item

Test item	Operation	Description
CORNERING LAMP	Off	NOTE: The item is indicated, but cannot be tested.
	LH	
	RH	
HORN	On	Operates horn relay 1 and horn relay 2 for 20 ms.
FRONT WIPER	Off	OFF
	Lo	Operates the front wiper relay.
	Hi	Operates the front wiper relay and front wiper high relay.
MOTOR FAN	1	OFF
	2	Outputs 50% pulse duty signal (PWM signal) to the cooling fan control module.
	3	Outputs 80% pulse duty signal (PWM signal) to the cooling fan control module.
	4	Outputs 100% pulse duty signal (PWM signal) to the cooling fan control module.
HEAD LAMP WASHER	On	NOTE: The item is indicated, but cannot be tested.
EXTERNAL LAMPS	Off	OFF
	TAIL	Operates the tail lamp relay.
	Lo	Operates the headlamp low relay.
	Hi	Operates the headlamp low relay and ON/OFF the headlamp high relay at 1 second intervals.
	Fog	Operates the front fog lamp relay.

P1610 LOCK MODE

< DTC/CIRCUIT DIAGNOSIS >

DTC/CIRCUIT DIAGNOSIS

P1610 LOCK MODE

Description

INFOID:000000006471880

ECM forcibly switches to the mode that inhibits engine start, when engine start operation is performed 5 times or more while communication between ECM and BCM is not normal.

DTC Logic

INFOID:000000006471881

DTC DETECTION LOGIC

DTC No.	Trouble diagnosis name	DTC detecting condition	Possible cause
P1610	LOCK MODE	When ECM detects a communication malfunction between ECM and BCM 5 times or more	—

DTC CONFIRMATION PROCEDURE

1. PERFORM DTC CONFIRMATION PROCEDURE

1. Turn ignition switch ON.
2. Check "Self-diagnosis result" using CONSULT-III.

Is DTC detected?

- YES >> Go to [SEC-33. "Diagnosis Procedure"](#).
NO >> INSPECTION END

Diagnosis Procedure

INFOID:000000006471882

1. CHECK ENGINE START FUNCTION

1. Perform the check for DTC except DTC P1610.
2. Use CONSULT-III to erase DTC after fixing.
3. Turn ignition switch OFF.
4. Turn ignition switch ON when registered Intelligent Key is inserted into key slot and wait for 5 seconds.
5. Turn the ignition switch OFF and wait 5 seconds.
6. Repeat steps 4 and 5 twice (a total of 3 times).
7. Check that engine can start when registered Intelligent Key is inserted into key slot.

>> INSPECTION END

P1611 ID DISCORD, IMMUECM

< DTC/CIRCUIT DIAGNOSIS >

P1611 ID DISCORD, IMMUECM

Description

INFOID:000000006471883

BCM performs the ID verification with ECM that allows the engine to start. Start the engine if the ID is successfully verified. ECM prevents the engine from starting if the ID is not registered. BCM starts the communication with ECM if ignition switch is turned ON.

DTC Logic

INFOID:000000006471884

DTC DETECTION LOGIC

NOTE:

- If DTC P1611 is displayed with DTC U1000, first perform the trouble diagnosis for DTC U1000. Refer to [BCS-35, "DTC Logic"](#).
- If DTC P1611 is displayed with DTC U1010, first perform the trouble diagnosis for DTC U1010. Refer to [BCS-36, "DTC Logic"](#).

DTC No.	Trouble diagnosis name	DTC detecting condition	Possible cause
P1611	ID DISCORD, IMMUECM	The ID verification results between BCM and ECM are NG. Registration is necessary.	<ul style="list-style-type: none">• BCM• ECM

DTC CONFIRMATION PROCEDURE

1.PERFORM DTC CONFIRMATION PROCEDURE

1. Turn ignition switch ON under the following conditions.

A/T models

- Selector lever is in the P or N position
- Do not depress brake pedal

M/T models

- Do not depress clutch pedal
2. Check "Self-diagnosis result" using CONSULT-III.

Is DTC detected?

- YES >> Go to [SEC-34, "Diagnosis Procedure"](#).
NO >> INSPECTION END

Diagnosis Procedure

INFOID:000000006471885

1.PERFORM INITIALIZATION

Perform initialization using CONSULT-III. Reregister all Intelligent Keys.
For initialization and registration of Intelligent Key, refer to "CONSULT-III Operation Manual NATS-IVIS/NVIS".

Can the system be initialized and can the engine be started with reregistered Intelligent Key?

- YES >> INSPECTION END
NO >> GO TO 2.

2.REPLACE BCM

1. Replace BCM. Refer to [BCS-81, "Removal and Installation"](#).
2. Perform initialization using CONSULT-III.
For initialization, refer to "CONSULT-III Operation Manual NATS-IVIS/NVIS".

Can the system be initialized and can the engine be started with reregistered Intelligent Key?

- YES >> INSPECTION END
NO >> GO TO 3.

3.REPLACE ECM

1. Replace ECM. Refer to [EC-17, "ADDITIONAL SERVICE WHEN REPLACING CONTROL UNIT \(ECM\): Special Repair Requirement"](#).
2. Perform initialization using CONSULT-III.

P1611 ID DISCORD, IMMU-ECM

< DTC/CIRCUIT DIAGNOSIS >

For initialization, refer to "CONSULT-III Operation Manual NATS-IVIS/NVIS".

Can the system be initialized and can the engine be started with reregistered Intelligent Key?

YES >> INSPECTION END

NO >> GO TO 4.

4.CHECK INTERMITTENT INCIDENT

Refer to [GI-43, "Intermittent Incident"](#).

>> INSPECTION END

A

B

C

D

E

F

G

H

I

J

SEC

L

M

N

O

P

P1612 CHAIN OF ECM-IMMU

< DTC/CIRCUIT DIAGNOSIS >

P1612 CHAIN OF ECM-IMMU

Description

INFOID:000000006471886

BCM performs ID verification with ECM that allows the engine to start. Start the engine if the ID is successfully verified. ECM prevents the engine from starting if the ID is not registered. BCM starts the communication with ECM if ignition switch is turned ON.

DTC Logic

INFOID:000000006471887

DTC DETECTION LOGIC

NOTE:

- If DTC P1612 is displayed with DTC U1000, first perform the trouble diagnosis for DTC U1000. Refer to [BCS-35, "DTC Logic"](#).
- If DTC P1612 is displayed with DTC U1010, first perform the trouble diagnosis for DTC U1010. Refer to [BCS-36, "DTC Logic"](#).

DTC No.	Trouble diagnosis name	DTC detecting condition	Possible cause
P1612	CHAIN OF ECM-IMMU	Inactive communication between ECM and BCM	<ul style="list-style-type: none">• Harness or connectors (The CAN communication line is open or shorted)• BCM• ECM

DTC CONFIRMATION PROCEDURE

1. PERFORM DTC CONFIRMATION PROCEDURE

1. Turn ignition switch ON under the following conditions.

A/T models

- Selector lever is in the P or N position
- Do not depress brake pedal

M/T models

- Do not depress clutch pedal
2. Check "Self-diagnosis result" using CONSULT-III.

Is DTC detected?

- YES >> Go to [SEC-36, "Diagnosis Procedure"](#).
NO >> INSPECTION END

Diagnosis Procedure

INFOID:000000006471888

1. REPLACE BCM

1. Replace BCM. Refer to [BCS-81, "Removal and Installation"](#).
2. Perform initialization using CONSULT-III.
For initialization, refer to "CONSULT-III Operation Manual NATS-IVIS/NVIS".

Does the engine start?

- YES >> INSPECTION END
NO >> GO TO 2.

2. REPLACE ECM

Replace ECM. Refer to [EC-17, "ADDITIONAL SERVICE WHEN REPLACING CONTROL UNIT \(ECM\) : Special Repair Requirement"](#).

>> INSPECTION END

P1614 CHAIN OF IMMU-KEY

< DTC/CIRCUIT DIAGNOSIS >

P1614 CHAIN OF IMMU-KEY

Description

INFOID:000000006471889

Performs ID verification through BCM and Intelligent Key when push-button ignition switch is pressed. Prohibits the release of steering lock (models with steering lock unit) or start of engine when an unregistered ID of Intelligent Key is used.

DTC Logic

INFOID:000000006471890

DTC DETECTION LOGIC

DTC No.	Trouble diagnosis name	DTC detecting condition	Possible cause
P1614	CHAIN OF IMMU-KEY	Inactive communication between key slot and BCM.	<ul style="list-style-type: none">• Harness or connectors (The key slot circuit is open or shorted)• Key slot• BCM

DTC CONFIRMATION PROCEDURE

1. PERFORM DTC CONFIRMATION PROCEDURE 1

1. Insert Intelligent Key into the key slot.
2. Check "Self-diagnosis result" using CONSULT-III.

Is DTC detected?

- YES >> Go to [SEC-37, "Diagnosis Procedure"](#).
NO >> GO TO 2.

2. PERFORM DTC CONFIRMATION PROCEDURE 2

1. Press the push-button ignition switch.
2. Check "Self-diagnosis result" using CONSULT-III.

Is DTC detected?

- YES >> Go to [SEC-37, "Diagnosis Procedure"](#).
NO >> INSPECTION END

Diagnosis Procedure

INFOID:000000006471891

1. INSPECTION START

Perform inspection in accordance with procedure that confirms DTC.

Which procedure confirms DTC?

- DTC confirmation procedure 1 >> GO TO 2.
DTC confirmation procedure 2 >> GO TO 4.

2. CHECK KEY SLOT INPUT SIGNAL

1. Turn ignition switch OFF.
2. Disconnect key slot connector.
3. Check voltage between key slot harness connector and ground.

(+)		(-)	Voltage (V) (Approx.)
Key slot			
Connector	Terminal		
M22	2	Ground	Battery voltage

Is the inspection result normal?

- YES >> Replace key slot. Refer to [SEC-214, "Removal and Installation"](#).
NO >> GO TO 3.

P1614 CHAIN OF IMMU-KEY

< DTC/CIRCUIT DIAGNOSIS >

3. CHECK KEY SLOT CIRCUIT

1. Disconnect BCM connector.
2. Check continuity between key slot harness connector and BCM harness connector.

Key slot		BCM		Continuity
Connector	Terminal	Connector	Terminal	
M22	2	M122	80	Existed

3. Check continuity between key slot harness connector and ground.

Key slot		Ground	Continuity
Connector	Terminal		
M22	2		Not existed

Is the inspection result normal?

- YES >> Replace BCM. Refer to [BCS-81, "Removal and Installation"](#).
 NO >> Repair or replace harness.

4. CHECK PUSH-BUTTON IGNITION SWITCH OPERATION

Press push-button ignition switch and check if it turns ON.

Does ignition switch turn to ON?

- YES >> GO TO 5.
 NO >> GO TO 7.

5. CHECK KEY SLOT COMMUNICATION SIGNAL

1. Turn ignition switch OFF.
2. Disconnect key slot connector.
3. Check voltage between key slot harness connector and ground.

(+)		(-)	Voltage (V) (Approx.)
Key slot			
Connector	Terminal		
M22	3	Ground	Battery voltage

Is the inspection result normal?

- YES >> Replace key slot. Refer to [SEC-214, "Removal and Installation"](#).
 NO >> GO TO 6.

6. CHECK KEY SLOT COMMUNICATION SIGNAL CIRCUIT

1. Disconnect BCM connector.
2. Check continuity between key slot harness connector and BCM harness connector.

Key slot		BCM		Continuity
Connector	Terminal	Connector	Terminal	
M22	3	M122	81	Existed

3. Check continuity between key slot harness connector and ground.

Key slot		Ground	Continuity
Connector	Terminal		
M22	3		Not existed

Is the inspection result normal?

- YES >> Replace BCM. Refer to [BCS-81, "Removal and Installation"](#).
 NO >> Repair or replace harness.

7. CHECK KEY SLOT GROUND CIRCUIT

P1614 CHAIN OF IMMU-KEY

< DTC/CIRCUIT DIAGNOSIS >

1. Turn ignition switch OFF.
2. Disconnect key slot connector.
3. Check continuity between key slot harness connector and ground.

Key slot		Ground	Continuity
Connector	Terminal		
M22	7		Existed

Is the inspection result normal?

- YES >> GO TO 8.
NO >> Repair or replace harness.

8. CHECK INTERMITTENT INCIDENT

Refer to [GI-43. "Intermittent Incident"](#).

>> INSPECTION END

A
B
C
D
E
F
G
H
I
J
L
M
N
O
P

SEC

P1615 DIFFERENCE OF KEY

< DTC/CIRCUIT DIAGNOSIS >

P1615 DIFFERENCE OF KEY

Description

INFOID:000000006471892

Performs ID verification through BCM and Intelligent Key when push-button ignition switch is pressed. Prohibits the release of steering lock (models with steering lock unit) or start of engine when an unregistered ID of Intelligent Key is used.

DTC Logic

INFOID:000000006471893

DTC DETECTION LOGIC

DTC No.	Trouble diagnosis name	DTC detecting condition	Possible cause
P1615	DIFFERENCE OF KEY	The ID verification results between BCM and Intelligent Key are NG. Registration is necessary.	Intelligent Key

DTC CONFIRMATION PROCEDURE

1.PERFORM DTC CONFIRMATION PROCEDURE

1. Press the push-button ignition switch.
2. Check "Self-diagnosis result" using CONSULT-III.

Is DTC detected?

- YES >> Go to [SEC-40. "Diagnosis Procedure"](#).
NO >> INSPECTION END

Diagnosis Procedure

INFOID:000000006471894

1.PERFORM INITIALIZATION

Perform initialization using CONSULT-III. Reregister all Intelligent Keys. For initialization and registration of Intelligent Key, refer to "CONSULT-III Operation Manual NATS-IVIS/NVIS".

Can the system be initialized and can the engine be started with reregistered Intelligent Key?

- YES >> INSPECTION END
NO >> GO TO 2.

2.REPLACE INTELLIGENT KEY

1. Replace Intelligent Key.
2. Perform initialization using CONSULT-III.
For initialization and registration of Intelligent Key, refer to "CONSULT-III Operation Manual NATS-IVIS/NVIS".

Can the system be initialized and can the engine be started with reregistered Intelligent Key?

- YES >> INSPECTION END
NO >> GO TO 3.

3.CHECK INTERMITTENT INCIDENT

Refer to [GI-43. "Intermittent Incident"](#).

>> INSPECTION END

B2190 NATS ANTENNA AMP.

< DTC/CIRCUIT DIAGNOSIS >

B2190 NATS ANTENNA AMP.

Description

INFOID:000000006471895

Performs ID verification through BCM and Intelligent Key when push-button ignition switch is pressed. Prohibits the release of steering lock (models with steering lock unit) or start of engine when an unregistered ID of Intelligent Key is used.

DTC Logic

INFOID:000000006471896

DTC DETECTION LOGIC

DTC No.	Trouble diagnosis name	DTC detecting condition	Possible cause
B2190	NATS ANTENNA AMP	Inactive communication between key slot and BCM.	<ul style="list-style-type: none"> • Harness or connectors (The key slot circuit is open or shorted) • Key slot • BCM

DTC CONFIRMATION PROCEDURE

1. PERFORM DTC CONFIRMATION PROCEDURE 1

1. Insert Intelligent Key into the key slot.
2. Check "Self-diagnosis result" using CONSULT-III.

Is DTC detected?

- YES >> Go to [SEC-41, "Diagnosis Procedure"](#).
 NO >> GO TO 2.

2. PERFORM DTC CONFIRMATION PROCEDURE 2

1. Press the push-button ignition switch.
2. Check "Self-diagnosis result" using CONSULT-III.

Is DTC detected?

- YES >> Go to [SEC-41, "Diagnosis Procedure"](#).
 NO >> INSPECTION END

Diagnosis Procedure

INFOID:000000006471897

1. INSPECTION START

Perform inspection in accordance with the appropriate confirmation procedure DTC.

Which procedure confirms DTC?

- DTC confirmation procedure 1 >> GO TO 2.
 DTC confirmation procedure 2 >> GO TO 4.

2. CHECK KEY SLOT INPUT SIGNAL

1. Turn ignition switch OFF.
2. Disconnect key slot connector.
3. Check voltage between key slot harness connector and ground.

(+)		(-)	Voltage (V) (Approx.)
Key slot			
Connector	Terminal		
M22	2	Ground	Battery voltage

Is the inspection result normal?

- YES >> Replace key slot. Refer to [SEC-214, "Removal and Installation"](#).
 NO >> GO TO 3.

B2190 NATS ANTENNA AMP.

< DTC/CIRCUIT DIAGNOSIS >

3. CHECK KEY SLOT CIRCUIT

1. Disconnect BCM connector.
2. Check continuity between key slot harness connector and BCM harness connector.

Key slot		BCM		Continuity
Connector	Terminal	Connector	Terminal	
M22	2	M122	80	Existed

3. Check continuity between key slot harness connector and ground.

Key slot		Ground	Continuity
Connector	Terminal		
M22	2		Not existed

Is the inspection result normal?

YES >> Replace BCM. Refer to [BCS-81, "Removal and Installation"](#).

NO >> Repair or replace harness.

4. CHECK PUSH-BUTTON IGNITION SWITCH OPERATION

Press push-button ignition switch and check if it turns ON.

Does ignition switch turn to ON?

YES >> GO TO 5.

NO >> GO TO 7.

5. CHECK KEY SLOT COMMUNICATION SIGNAL

1. Turn ignition switch OFF.
2. Disconnect key slot connector.
3. Check voltage between key slot harness connector and ground.

(+)		(-)	Voltage (V) (Approx.)
Key slot			
Connector	Terminal		
M22	3	Ground	Battery voltage

Is the inspection result normal?

YES >> Replace key slot. Refer to [SEC-214, "Removal and Installation"](#).

NO >> GO TO 6.

6. CHECK KEY SLOT COMMUNICATION SIGNAL CIRCUIT

1. Disconnect BCM connector.
2. Check continuity between key slot harness connector and BCM harness connector.

Key slot		BCM		Continuity
Connector	Terminal	Connector	Terminal	
M22	3	M122	81	Existed

3. Check continuity between key slot harness connector and ground.

Key slot		Ground	Continuity
Connector	Terminal		
M22	3		Not existed

Is the inspection result normal?

YES >> Replace BCM. Refer to [BCS-81, "Removal and Installation"](#).

NO >> Repair or replace harness.

7. CHECK KEY SLOT GROUND CIRCUIT

B2190 NATS ANTENNA AMP.

< DTC/CIRCUIT DIAGNOSIS >

1. Turn ignition switch OFF.
2. Disconnect key slot connector.
3. Check continuity between key slot harness connector and ground.

Key slot		Ground	Continuity
Connector	Terminal		
M22	7		Existed

Is the inspection result normal?

YES >> GO TO 8.

NO >> Repair or replace harness.

8. CHECK INTERMITTENT INCIDENT

Refer to [GI-43. "Intermittent Incident"](#).

>> INSPECTION END

A
B
C
D
E
F
G
H
I
J
L
M
N
O
P

SEC

B2191 DIFFERENCE OF KEY

< DTC/CIRCUIT DIAGNOSIS >

B2191 DIFFERENCE OF KEY

Description

INFOID:000000006471898

Performs ID verification through BCM and Intelligent Key when push-button ignition switch is pressed. Prohibits the release of steering lock (models with steering lock unit) or start of engine when an unregistered ID of Intelligent Key is used.

DTC Logic

INFOID:000000006471899

DTC DETECTION LOGIC

DTC No.	Trouble diagnosis name	DTC detecting condition	Possible cause
B2191	DIFFERENCE OF KEY	The ID verification results between BCM and Intelligent Key are NG. Registration is necessary.	Intelligent Key

DTC CONFIRMATION PROCEDURE

1.PERFORM DTC CONFIRMATION PROCEDURE

1. Press the push-button ignition switch.
2. Check "Self-diagnosis result" using CONSULT-III.

Is DTC detected?

- YES >> Go to [SEC-44. "Diagnosis Procedure"](#).
NO >> INSPECTION END

Diagnosis Procedure

INFOID:000000006471900

1.PERFORM INITIALIZATION

Perform initialization using CONSULT-III. Reregister all Intelligent Keys. For initialization and registration of Intelligent Key, refer to "CONSULT-III Operation Manual NATS-IVIS/NVIS".

Can the system be initialized and can the engine be started with reregistered Intelligent Key?

- YES >> INSPECTION END
NO >> GO TO 2.

2.REPLACE INTELLIGENT KEY

1. Replace Intelligent Key.
2. Perform initialization using CONSULT-III. For initialization and registration of Intelligent Key, refer to "CONSULT-III Operation Manual NATS-IVIS/NVIS".

Can the system be initialized and can the engine be started with reregistered Intelligent Key?

- YES >> INSPECTION END
NO >> GO TO 3.

3.CHECK INTERMITTENT INCIDENT

Refer to [GI-43. "Intermittent Incident"](#).

>> INSPECTION END

B2192 ID DISCORD, IMMUECM

< DTC/CIRCUIT DIAGNOSIS >

B2192 ID DISCORD, IMMUECM

Description

INFOID:000000006471901

BCM performs ID verification with ECM that allows the engine to start. Start the engine if the ID is successfully verified. ECM prevents the engine from starting if the ID is not registered. BCM starts the communication with ECM if ignition switch is turned ON.

DTC Logic

INFOID:000000006471902

DTC DETECTION LOGIC

NOTE:

- If DTC B2192 is displayed with DTC U1000, first perform the trouble diagnosis for DTC U1000. Refer to [BCS-35, "DTC Logic"](#).
- If DTC B2192 is displayed with DTC U1010, first perform the trouble diagnosis for DTC U1010. Refer to [BCS-36, "DTC Logic"](#).

DTC No.	Trouble diagnosis name	DTC detecting condition	Possible cause
B2192	ID DISCORD, BCM-ECM	The ID verification results between BCM and ECM are NG. Registration is necessary.	<ul style="list-style-type: none">• BCM• ECM

DTC CONFIRMATION PROCEDURE

1. PERFORM DTC CONFIRMATION PROCEDURE

1. Turn ignition switch ON under the following conditions.

A/T models

- Selector lever is in the P or N position
- Do not depress brake pedal

M/T models

- Do not depress clutch pedal
2. Check "Self-diagnosis result" using CONSULT-III.

Is DTC detected?

- YES >> Go to [SEC-45, "Diagnosis Procedure"](#).
- NO >> INSPECTION END

Diagnosis Procedure

INFOID:000000006471903

1. PERFORM INITIALIZATION

Perform initialization using CONSULT-III. Reregister all Intelligent Keys.
For initialization and registration of Intelligent Key, refer to "CONSULT-III Operation Manual NATS-IVIS/NVIS".

Can the system be initialized and can the engine be started with reregistered Intelligent Key?

- YES >> INSPECTION END
- NO >> GO TO 2.

2. REPLACE BCM

1. Replace BCM. Refer to [BCS-81, "Removal and Installation"](#).
2. Perform initialization using CONSULT-III.
For initialization, refer to "CONSULT-III Operation Manual NATS-IVIS/NVIS".

Can the system be initialized and can the engine be started with reregistered Intelligent Key?

- YES >> INSPECTION END
- NO >> GO TO 3.

3. REPLACE ECM

1. Replace ECM. Refer to [EC-17, "ADDITIONAL SERVICE WHEN REPLACING CONTROL UNIT \(ECM\): Special Repair Requirement"](#).
2. Perform initialization using CONSULT-III.
For initialization, refer to "CONSULT-III Operation Manual NATS-IVIS/NVIS".

A
B
C
D
E
F
G
H
I
J
L
M
N
O
P

SEC

B2192 ID DISCORD, IMMUECM

< DTC/CIRCUIT DIAGNOSIS >

Can the system be initialized and can the engine be started with reregistered Intelligent Key?

YES >> INSPECTION END

NO >> GO TO 4.

4.CHECK INTERMITTENT INCIDENT

Refer to [GI-43, "Intermittent Incident"](#).

>> INSPECTION END

B2193 CHAIN OF ECM-IMMU

< DTC/CIRCUIT DIAGNOSIS >

B2193 CHAIN OF ECM-IMMU

Description

INFOID:000000006471904

BCM performs the ID verification with ECM that allows the engine to start. Start the engine if the ID is successfully verified. ECM prevents the engine from starting if the ID is not registered. BCM starts the communication with ECM if ignition switch is turned ON.

DTC Logic

INFOID:000000006471905

DTC DETECTION LOGIC

NOTE:

- If DTC B2193 is displayed with DTC U1000, first perform the trouble diagnosis for DTC U1000. Refer to [BCS-35, "DTC Logic"](#).
- If DTC B2193 is displayed with DTC U1010, first perform the trouble diagnosis for DTC U1010. Refer to [BCS-36, "DTC Logic"](#).

DTC No.	Trouble diagnosis name	DTC detecting condition	Possible cause
B2193	CHAIN OF ECM-BCM	Inactive communication between ECM and BCM	<ul style="list-style-type: none">• Harness or connectors (The CAN communication line is open or shorted)• BCM• ECM

DTC CONFIRMATION PROCEDURE

1.PERFORM DTC CONFIRMATION PROCEDURE

1. Turn ignition switch ON under the following conditions.

A/T models

- Selector lever is in the P or N position
- Do not depress brake pedal

M/T models

- Do not depress clutch pedal
2. Check "Self-diagnosis result" using CONSULT-III.

Is DTC detected?

- YES >> Go to [SEC-47, "Diagnosis Procedure"](#).
NO >> INSPECTION END

Diagnosis Procedure

INFOID:000000006471906

1.REPLACE BCM

1. Replace BCM. Refer to [BCS-81, "Removal and Installation"](#).
2. Perform initialization using CONSULT-III.
For initialization, refer to "CONSULT-III Operation Manual NATS-IVIS/NVIS".

Does the engine start?

- YES >> INSPECTION END
NO >> GO TO 2.

2.REPLACE ECM

Replace ECM. Refer to [EC-17, "ADDITIONAL SERVICE WHEN REPLACING CONTROL UNIT \(ECM\) : Special Repair Requirement"](#).

>> INSPECTION END

B2195 ANTI-SCANNING

< DTC/CIRCUIT DIAGNOSIS >

B2195 ANTI-SCANNING

Description

INFOID:000000006471907

When ignition switch is turned ON, BCM performs ID verification with ECM. If ID verification that is out of the specified specification is detected, BCM prohibits further ID verification and engine cranking.

DTC Logic

INFOID:000000006471908

DTC DETECTION LOGIC

DTC No.	Trouble diagnosis name	DTC detecting condition	Possible cause
B2195	ANTI-SCANNING	ID verification between BCM and ECM that is out of the specified specification is detected	ID verification request out of the specified specification

DTC CONFIRMATION PROCEDURE

1. PERFORM DTC CONFIRMATION PROCEDURE

1. Turn ignition switch ON under the following conditions.

A/T models

- Selector lever is in the P or N position
- Do not depress brake pedal

M/T models

- Do not depress clutch pedal
2. Check "Self-diagnosis result" using CONSULT-III.

Is DTC detected?

- YES >> Refer to [SEC-48. "Diagnosis Procedure"](#).
NO >> INSPECTION END.

Diagnosis Procedure

INFOID:000000006471909

1. CHECK SELF-DIAGNOSIS RESULT-1

1. Perform "Self-diagnosis result" of BCM using CONSULT-III.
2. Erase DTC.
3. Perform DTC Confirmation Procedure. Refer to [SEC-48. "DTC Logic"](#).

Is DTC 2195 detected?

- YES >> GO TO 2.
NO >> INSPECTION END

2. CHECK EQUIPMENT OF THE VEHICLE

Check that unspecified accessory part related to engine start is not installed.

Is unspecified accessory part related to engine start installed?

- YES >> GO TO 3.
NO >> Replace BCM. Refer to [BCS-81. "Removal and Installation"](#).

3. CHECK SELF-DIAGNOSIS RESULT-2

1. Obtain the customers approval to remove unspecified accessory part related to engine start, and then remove it.
2. Perform "Self-diagnosis result" of BCM using CONSULT-III.
3. Erase DTC.
4. Perform DTC Confirmation Procedure. Refer to [SEC-48. "DTC Logic"](#).

Is DTC 2195 detected?

- YES >> Replace BCM. Refer to [BCS-81. "Removal and Installation"](#).
NO >> INSPECTION END

B2013 STEERING LOCK UNIT

< DTC/CIRCUIT DIAGNOSIS >

B2013 STEERING LOCK UNIT

Description

INFOID:000000006471910

BCM performs the ID verification with the steering lock unit and releases the steering lock if both BCM and steering lock unit ID are same. BCM starts the communication with the steering lock unit when Intelligent Key is carried into the passenger compartment and the push-button ignition switch is pressed.

DTC Logic

INFOID:000000006471911

DTC DETECTION LOGIC

DTC No.	Trouble diagnosis name	DTC detecting condition	Possible cause
B2013	ID DISCORD, BCM-S/L	The ID verification results between BCM and steering lock unit are NG. Registration is necessary.	Steering lock unit

DTC CONFIRMATION PROCEDURE

1.PERFORM DTC CONFIRMATION PROCEDURE

1. Lock steering.
2. Press the push-button ignition switch.
3. Check "Self-diagnosis result" using CONSULT-III.

Is DTC detected?

- YES >> Go to [SEC-49. "Diagnosis Procedure"](#).
NO >> INSPECTION END

Diagnosis Procedure

INFOID:000000006471912

1.PERFORM INITIALIZATION

Perform initialization using CONSULT-III.
For initialization, refer to "CONSULT-III Operation Manual NATS-IVIS/NVIS".

Does steering lock operate?

- YES >> INSPECTION END
NO >> GO TO 2.

2.REPLACE STEERING LOCK UNIT

1. Replace steering lock unit.
2. Perform initialization using CONSULT-III.
For initialization, refer to "CONSULT-III Operation Manual NATS-IVIS/NVIS".

Does steering lock operate?

- YES >> INSPECTION END
NO >> GO TO 3.

3.CHECK INTERMITTENT INCIDENT

Refer to [GI-43. "Intermittent Incident"](#).

>> INSPECTION END

B2014 CHAIN OF STRG-IMMU

< DTC/CIRCUIT DIAGNOSIS >

B2014 CHAIN OF STRG-IMMU

Description

INFOID:000000006471913

BCM performs the ID verification with the steering lock unit to release the steering. BCM starts the communication with the steering lock unit when Intelligent Key is carried into the passenger compartment and the push-button ignition switch is pressed.

DTC Logic

INFOID:000000006471914

DTC DETECTION LOGIC

DTC No.	Trouble diagnosis name	DTC detecting condition	Possible cause
B2014	CHAIN OF S/L-BCM	Inactive communication between steering lock unit and BCM.	<ul style="list-style-type: none">• Harness or connectors (Steering lock unit circuit is open or shorted)• Steering lock unit• BCM

DTC CONFIRMATION PROCEDURE

1.PERFORM DTC CONFIRMATION PROCEDURE

1. Lock steering.
2. Press the push-button ignition switch.
3. Check "Self-diagnosis result" using CONSULT-III.

Is DTC detected?

- YES >> Go to [SEC-50. "Diagnosis Procedure"](#).
NO >> INSPECTION END

Diagnosis Procedure

INFOID:000000006471915

1.CHECK STEERING LOCK UNIT POWER SUPPLY

1. Turn ignition switch OFF.
2. Disconnect steering lock unit connector.
3. Check voltage between steering lock unit harness connector and ground.

(+)		(-)	Condition	Voltage (V) (Approx.)
Connector	Terminal			
M40	7	Ground	Ignition switch	OFF or ACC Battery voltage
				ON 0

Is the inspection result normal?

- YES >> GO TO 3.
NO >> GO TO 2.

2.CHECK STEERING LOCK UNIT POWER SUPPLY CIRCUIT

1. Disconnect BCM connector.
2. Check continuity between steering lock unit harness connector and BCM harness connector.

Steering lock unit		BCM		Continuity
Connector	Terminal	Connector	Terminal	
M40	7	M122	106	Existed

3. Check continuity between steering lock unit harness connector and ground.

B2014 CHAIN OF STRG-IMMU

< DTC/CIRCUIT DIAGNOSIS >

Steering lock unit		Ground	Continuity
Connector	Terminal		
M40	7		Not existed

Is the inspection result normal?

YES >> Replace BCM. Refer to [BCS-81, "Removal and Installation"](#).

NO >> Repair or replace harness.

3.CHECK STEERING LOCK UNIT GROUND CIRCUIT

Check continuity between steering lock unit and ground.

Steering lock unit		Ground	Continuity
Connector	Terminal		
M40	5		Existed
	6		

Is the inspection result normal?

YES >> GO TO 4.

NO >> Repair or replace harness.

4.CHECK STEERING LOCK UNIT COMMUNICATION SIGNAL

1. Connect steering lock unit connector and BCM connector.
2. Read voltage signal between steering lock unit harness connector and ground.

(+)		(-)	Condition	Voltage (V) (Approx.)
Connector	Terminal			
M40	2	Ground	Steering lock unit	Battery voltage
			Lock status	
			Lock or unlock	
			For 15 seconds after unlock	Battery voltage
			15 seconds or later after unlock.	0

Steering is locked : Opening the door when ignition switch is ON to OFF.

Steering is unlocked : Ignition switch is OFF to ACC.

Is the inspection result normal?

YES >> Replace steering lock unit.

NO >> GO TO 5.

5.CHECK STEERING LOCK UNIT COMMUNICATION CIRCUIT

1. Disconnect steering lock unit and BCM connector.
2. Check continuity between steering lock unit harness connector and BCM harness connector.

Steering lock unit		BCM		Continuity
Connector	Terminal	Connector	Terminal	
M40	2	M122	111	Existed

B2014 CHAIN OF STRG-IMMU

< DTC/CIRCUIT DIAGNOSIS >

3. Check continuity between steering lock unit harness connector and ground.

Steering lock unit		Ground	Continuity
Connector	Terminal		
M40	2		Not existed

Is the inspection result normal?

YES >> Replace BCM. Refer to [BCS-81, "Removal and Installation"](#).

NO >> Repair or replace harness.

B2555 STOP LAMP

< DTC/CIRCUIT DIAGNOSIS >

B2555 STOP LAMP

Description

INFOID:000000006471916

BCM detects the stop lamp status and confirms the stop lamp switch ON/OFF status. BCM confirms the engine start condition according to the stop lamp switch ON/OFF status.

DTC Logic

INFOID:000000006471917

DTC DETECTION LOGIC

DTC No.	Trouble diagnosis name	DTC detecting condition	Possible cause
B2555	STOP LAMP	BCM makes a comparison between the upper voltage and lower voltage of stop lamp switch. It judges from their values to detect the malfunctioning circuit.	<ul style="list-style-type: none">• Harness or connectors (stop lamp switch circuit is open or shorted)• Stop lamp switch• Fuse

DTC CONFIRMATION PROCEDURE

1. PERFORM DTC CONFIRMATION PROCEDURE

1. Depress the brake pedal and wait 1 second or more.
2. Check "Self-diagnosis result" using CONSULT-III.

Is DTC detected?

- YES >> Go to [SEC-53, "Diagnosis Procedure"](#).
NO >> INSPECTION END

Diagnosis Procedure

INFOID:000000006471918

1. CHECK STOP LAMP SWITCH INPUT SIGNAL

1. Turn ignition switch OFF.
2. Disconnect BCM connector.
3. Check voltage between BCM harness connector and ground.

(+)		(-)	Voltage (V) (Approx.)
BCM			
Connector	Terminal		
M123	116	Ground	Battery voltage

Is the inspection normal?

- YES >> GO TO 2.
NO-1 >> Check 10 A fuse [No. 7, located in the fuse block (J/B)].
NO-2 >> Check harness for open or short between BCM and fuse.

2. CHECK STOP LAMP SWITCH POWER SUPPLY CIRCUIT

1. Disconnect stop lamp switch connector.
2. Check voltage between stop lamp harness connector and ground.

(+)		(-)	Voltage (V) (Approx.)
Stop lamp switch			
Connector	Terminal		
E110	3	Ground	Battery voltage

Is the inspection result normal?

- YES >> GO TO 3.
NO >> Check harness for open or short to stop lamp switch.

3. CHECK STOP LAMP SWITCH CIRCUIT

B2555 STOP LAMP

< DTC/CIRCUIT DIAGNOSIS >

1. Check continuity between stop lamp switch harness connector and BCM harness connector.

Stop lamp switch		BCM		Continuity
Connector	Terminal	Connector	Terminal	
E110	4	M123	118	Existed

2. Check continuity between stop lamp switch harness connector and ground.

Stop lamp switch		Ground	Continuity
Connector	Terminal		
E110	4		Not existed

Is the inspection result normal?

- YES >> GO TO 4.
 NO >> Repair or replace harness.

4.CHECK STOP LAMP SWITCH

Refer to [SEC-54, "Component Inspection"](#).

Is the inspection result normal?

- YES >> GO TO 5.
 NO >> Replace stop lamp switch. Refer to [BR-19, "Exploded View"](#).

5.CHECK INTERMITTENT INCIDENT

Refer to [GI-43, "Intermittent Incident"](#).

>> INSPECTION END

Component Inspection

INFOID:000000006471919

1.CHECK STOP LAMP SWITCH

1. Turn ignition switch OFF.
2. Disconnect stop lamp switch connector.
3. Check continuity between stop lamp switch terminals.

Stop lamp switch		Condition	Continuity	
Terminal				
3	4	Brake pedal	Not depressed	Not existed
			Depressed	Existed

Is the inspection result normal?

- YES >> INSPECTION END
 NO >> Replace stop lamp switch. Refer to [BR-19, "Exploded View"](#).

B2556 PUSH-BUTTON IGNITION SWITCH

< DTC/CIRCUIT DIAGNOSIS >

B2556 PUSH-BUTTON IGNITION SWITCH

Description

INFOID:000000006471920

The switch changes the power supply position. BCM maintains the power supply position status. BCM changes the power supply position with the operation of the push-button ignition switch.

DTC Logic

INFOID:000000006471921

DTC DETECTION LOGIC

DTC No.	Trouble diagnosis name	DTC detecting condition	Possible cause
B2556	PUSH-BTN IGN SW	BCM detects the push-button ignition switch stuck at ON for 100 seconds or more.	<ul style="list-style-type: none"> • Harness or connectors (Push-button ignition switch circuit is shorted.) • Push-button ignition switch • BCM

DTC CONFIRMATION PROCEDURE

1. PERFORM DTC CONFIRMATION PROCEDURE

1. Start the engine and wait 100 seconds or more.
2. Check "Self-diagnosis result" using CONSULT-III.

Is DTC detected?

- YES >> Go to [SEC-55, "Diagnosis Procedure"](#).
 NO >> INSPECTION END

Diagnosis Procedure

INFOID:000000006471922

1. CHECK PUSH-BUTTON IGNITION SWITCH INPUT SIGNAL

1. Turn ignition switch OFF.
2. Disconnect push-button ignition switch connector.
3. Check voltage between push-button ignition switch harness connector and ground.

(+)		(-)	Voltage (V) (Approx.)
Push-button ignition switch			
Connector	Terminal	Ground	Battery voltage
M50	4		

Is the inspection result normal?

- YES >> GO TO 3.
 NO >> GO TO 2.

2. CHECK PUSH-BUTTON IGNITION SWITCH CIRCUIT

1. Disconnect BCM connector and IPDM E/R connector.
2. Check continuity between push-button ignition switch harness connector and BCM harness connector.

Push-button ignition switch		BCM		Continuity
Connector	Terminal	Connector	Terminal	
M50	4	M121 (Models without steering lock unit)	60	Existed
		M122 (Models with steering lock unit)	89	

3. Check continuity between push-button ignition switch harness connector and ground.

B2556 PUSH-BUTTON IGNITION SWITCH

< DTC/CIRCUIT DIAGNOSIS >

Push-button ignition switch		Ground	Continuity
Connector	Terminal		
M50	4		Not existed

Is the inspection result normal?

YES >> Replace BCM. Refer to [BCS-81, "Removal and Installation"](#).

NO >> Repair or replace harness.

3.CHECK PUSH-BUTTON IGNITION SWITCH GROUND CIRCUIT

Check continuity between push-button ignition switch harness connector and ground.

Push-button ignition switch		Ground	Continuity
Connector	Terminal		
M50	1		Existed

Is the inspection result normal?

YES >> GO TO 4.

NO >> Repair or replace harness.

4.CHECK PUSH-BUTTON IGNITION SWITCH

Refer to [SEC-56, "Component Inspection"](#).

Is the inspection result normal?

YES >> GO TO 5.

NO >> Replace push-button ignition switch. Refer to [SEC-215, "Removal and Installation"](#).

5.CHECK INTERMITTENT INCIDENT

Refer to [GI-43, "Intermittent Incident"](#).

>> INSPECTION END

Component Inspection

INFOID:000000006471923

1.CHECK PUSH-BUTTON IGNITION SWITCH

1. Turn ignition switch OFF.
2. Disconnect push-button ignition switch connector.
3. Check continuity between push-button ignition switch terminals.

Push-button ignition switch		Condition	Continuity	
Terminal				
1	4	Push-button ignition switch	Pressed	Existed
			Not pressed	Not existed

Is the inspection result normal?

YES >> INSPECTION END

NO >> Replace push-button ignition switch. Refer to [SEC-215, "Removal and Installation"](#).

B2557 VEHICLE SPEED

< DTC/CIRCUIT DIAGNOSIS >

B2557 VEHICLE SPEED

Description

INFOID:000000006471924

BCM receives 2 vehicle speed signals via CAN communication. 1 signal is transmitted by the “unified meter and A/C amp.”. Another signal is transmitted by “ABS actuator and electric unit (control unit.)”. BCM compares both signals to detect the vehicle speed.

DTC Logic

INFOID:000000006471925

DTC DETECTION LOGIC

NOTE:

- If DTC B2557 is displayed with DTC U1000, first perform the trouble diagnosis for DTC U1000. Refer to [BCS-35, "DTC Logic"](#).
- If DTC B2557 is displayed with DTC U1010, first perform the trouble diagnosis for DTC U1010. Refer to [BCS-36, "DTC Logic"](#).

DTC No.	Self-diagnosis name	DTC detecting condition	Possible causes
B2557	VEHICLE SPEED	BCM detects the following difference between the vehicle speed signal from “unified meter and A/C amp.” and the one from “ABS actuator and electric unit” for 10 seconds continuously. <ul style="list-style-type: none">• One is 10 km/h (6.2 MPH) or more and the other is 4 km/h (2.5 MPH) or less	<ul style="list-style-type: none">• Wheel sensor• Unified meter and A/C amp.• ABS actuator and electric unit (control unit)

DTC CONFIRMATION PROCEDURE

1. PERFORM DTC CONFIRMATION PROCEDURE

1. Drive the vehicle at the vehicle speed of 10 km/h (6.2 MPH) or more and wait 10 seconds or more.
2. Check “Self-diagnosis result” using CONSULT-III.

Is DTC detected?

- YES >> Go to [SEC-57, "Diagnosis Procedure"](#).
NO >> INSPECTION END

Diagnosis Procedure

INFOID:000000006471926

1. CHECK DTC WITH “ABS ACTUATOR AND ELECTRIC UNIT (CONTROL UNIT)”

Check “Self-diagnosis result” using CONSULT-III. Refer to [BRC-103, "DTC Index"](#).

Is the inspection result normal?

- YES >> GO TO 2.
NO >> Repair or replace the malfunctioning parts.

2. CHECK DTC WITH “COMBINATION METER”

Check “Self-diagnosis result” using CONSULT-III. Refer to [MWI-81, "DTC Index"](#).

Is the inspection result normal?

- YES >> GO TO 3.
NO >> Repair or replace the malfunctioning parts.

3. CHECK INTERMITTENT INCIDENT

Refer to [GI-43, "Intermittent Incident"](#).

>> INSPECTION END

A
B
C
D
E
F
G
H
I
J
L
M
N
O
P

SEC

B2560 STARTER CONTROL RELAY

< DTC/CIRCUIT DIAGNOSIS >

B2560 STARTER CONTROL RELAY

Description

INFOID:000000006471927

Starter control relay, integrated in IPDM E/R, permits the starter relay operation when in the N or P position and the steering is locked or unlocked (models with steering lock unit). It is installed parallel to the starter relay.

DTC Logic

INFOID:000000006471928

DTC DETECTION LOGIC

NOTE:

- If DTC B2560 is displayed with DTC U1000, first perform the trouble diagnosis for DTC U1000. Refer to [BCS-35, "DTC Logic"](#).
- If DTC B2560 is displayed with DTC U1010, first perform the trouble diagnosis for DTC U1010. Refer to [BCS-36, "DTC Logic"](#).

DTC No.	Self-diagnosis name	DTC detecting condition	Possible causes
B2560	STARTER CONTROL RELAY	BCM detects a discrepancy between the OFF request of starter control relay to IPDM E/R and the feedback. (The feedback is ON instead of OFF.)	IPDM E/R

DTC CONFIRMATION PROCEDURE

1. PERFORM DTC CONFIRMATION PROCEDURE

1. Turn ignition switch ON under the following conditions and wait 2 seconds or more.

A/T models

- Selector lever is in the P or N position
- Do not depress brake pedal

M/T models

- Do not depress clutch pedal
2. Check "Self-diagnosis result" using CONSULT-III.

Is DTC detected?

- YES >> Go to [SEC-58, "Diagnosis Procedure"](#).
- NO >> INSPECTION END

Diagnosis Procedure

INFOID:000000006471929

1. CHECK DTC WITH IPDM E/R

Check "Self-diagnosis result" using CONSULT-III. Refer to [PCS-31, "DTC Index"](#).

Is the inspection result normal?

- YES >> GO TO 2.
- NO >> Replace IPDM E/R. Refer to [PCS-34, "Removal and Installation"](#).

2. CHECK INTERMITTENT INCIDENT

Refer to [GI-43, "Intermittent Incident"](#).

>> INSPECTION END

B2601 SHIFT POSITION

< DTC/CIRCUIT DIAGNOSIS >

B2601 SHIFT POSITION

Description

INFOID:000000006471930

BCM confirms the shift position with the following 4 signals.

- Selector lever
- Transmission range switch
- P position signal from IPDM E/R (CAN)
- P position signal from TCM (CAN)

DTC Logic

INFOID:000000006471931

DTC DETECTION LOGIC

NOTE:

- If DTC B2601 is displayed with DTC U1000, first perform the trouble diagnosis for DTC U1000. Refer to [BCS-35. "DTC Logic"](#).
- If DTC B2601 is displayed with DTC U1010, first perform the trouble diagnosis for DTC U1010. Refer to [BCS-36. "DTC Logic"](#).

DTC No.	Trouble diagnosis name	DTC detecting condition	Possible cause
B2601	SHIFT POSITION	BCM detects when a difference between the shift P input signal and the shift position signal received from IPDM E/R via CAN communication continues for 2 seconds or more.	<ul style="list-style-type: none"> • Harness or connectors (A/T shift selector circuit is open or shorted) • A/T shift selector (detention switch)

DTC CONFIRMATION PROCEDURE

1. PERFORM DTC CONFIRMATION PROCEDURE

1. Turn ignition switch ON under the following conditions and wait 2 seconds or more.
 - Selector lever is in the P or N position
 - Do not depress brake pedal
2. Check "Self-diagnosis result" using CONSULT-III.

Is DTC detected?

- YES >> Go to [SEC-59. "Diagnosis Procedure"](#).
 NO >> INSPECTION END

Diagnosis Procedure

INFOID:000000006471932

1. CHECK A/T SHIFT SELECTOR POWER SUPPLY

1. Turn ignition switch OFF.
2. Disconnect A/T shift selector (detention switch) connector.
3. Check voltage between A/T shift selector (detention switch) harness connector and ground.

(+)		(-)	Voltage (V) (Approx.)
Connector	Terminal		
A/T shift selector (detention switch)		Ground	Battery voltage
M137	10		

Is the inspection result normal?

- YES >> GO TO 3.
 NO >> GO TO 2.

2. CHECK A/T SHIFT SELECTOR POWER SUPPLY CIRCUIT

1. Disconnect BCM connector.
2. Check continuity between A/T shift selector (detention switch) harness connector and BCM harness connector.

A
B
C
D
E
F
G
H
I
J
L
M
N
O
P

SEC

B2601 SHIFT POSITION

< DTC/CIRCUIT DIAGNOSIS >

A/T shift selector (detention switch)		BCM		Continuity
Connector	Terminal	Connector	Terminal	
M137	10	M122	96	Existed

3. Check continuity between A/T shift selector (detention switch) harness connector and ground.

A/T shift selector (detention switch)		Ground	Continuity
Connector	Terminal		
M137	10		Not existed

Is the inspection result normal?

YES >> Replace BCM. Refer to [BCS-81, "Removal and Installation"](#).

NO >> Repair or replace harness.

3.CHECK A/T SHIFT SELECTOR CIRCUIT (BCM)

1. Disconnect BCM connector and IPDM E/R connector.
2. Check continuity between A/T shift selector (detention switch) harness connector and BCM harness connector.

A/T shift selector (detention switch)		BCM		Continuity
Connector	Terminal	Connector	Terminal	
M137	11	M122	99	Existed

3. Check continuity between A/T shift selector (detention switch) harness connector and ground.

A/T shift selector (detention switch)		Ground	Continuity
Connector	Terminal		
M137	11		Not existed

Is the inspection result normal?

YES >> GO TO 4.

NO >> Repair or replace harness.

4.CHECK A/T SHIFT SELECTOR CIRCUIT (IPDM E/R)

Check continuity between A/T shift selector (detention switch) harness connector and IPDM E/R harness connector.

A/T shift selector (detention switch)		IPDM E/R		Continuity
Connector	Terminal	Connector	Terminal	
M137	11	E6	43	Existed

Is the inspection result normal?

YES >> GO TO 5.

NO >> Repair or replace harness.

5.CHECK A/T SHIFT SELECTOR (DETENTION SWITCH)

Refer to [SEC-61, "Component Inspection"](#).

Is the inspection result normal?

YES >> GO TO 6.

NO >> Replace A/T shift selector. Refer to [TM-282, "Removal and Installation"](#).

6.CHECK INTERMITTENT INCIDENT

Refer to [GI-43, "Intermittent Incident"](#).

>> INSPECTION END

B2601 SHIFT POSITION

< DTC/CIRCUIT DIAGNOSIS >

Component Inspection

INFOID:000000006471933

1. CHECK A/T SHIFT SELECTOR (DETENTION SWITCH)

1. Turn ignition switch OFF.
2. Disconnect A/T shift selector connector.
3. Check continuity between A/T shift selector (detention switch) terminals.

A/T shift selector (detention switch)		Condition		Continuity
Terminal				
10	11	Selector lever	P position	Not existed
			Other than above	Existed

Is the inspection result normal?

YES >> INSPECTION END

NO >> Replace A/T shift selector. Refer to [TM-282, "Removal and Installation"](#).

A
B
C
D
E
F
G
H
I
J
L
M
N
O
P

SEC

B2602 SHIFT POSITION

< DTC/CIRCUIT DIAGNOSIS >

B2602 SHIFT POSITION

Description

INFOID:000000006471934

BCM confirms the shift position with the following 4 signals.

- Selector lever
- Transmission range switch
- P position signal from IPDM E/R (CAN)
- P position signal from TCM (CAN)

DTC Logic

INFOID:000000006471935

DTC DETECTION LOGIC

NOTE:

- If DTC B2602 is displayed with DTC U1000, first perform the trouble diagnosis for DTC U1000. Refer to [BCS-35, "DTC Logic"](#).
- If DTC B2602 is displayed with DTC U1010, first perform the trouble diagnosis for DTC U1010. Refer to [BCS-36, "DTC Logic"](#).

DTC No.	Trouble diagnosis name	DTC detecting condition	Possible cause
B2602	SHIFT POSITION	BCM detects the following status for 10 seconds. <ul style="list-style-type: none"> • Shift position is in the P position • Vehicle speed is 4 km/h (2.5 MPH) or more • Ignition switch is in the ON position 	<ul style="list-style-type: none"> • Harness or connectors (A/T shift selector circuit is open or shorted) • A/T shift selector (detention switch) • ABS actuator and electric unit (control unit)

DTC CONFIRMATION PROCEDURE

1. PERFORM DTC CONFIRMATION PROCEDURE

1. Start engine.
2. Drive vehicle at a speed of 4 km/h or more for at least 10 seconds.
3. Check "Self-diagnosis result" using CONSULT-III.

Is DTC detected?

- YES >> Go to [SEC-62, "Diagnosis Procedure"](#).
 NO >> INSPECTION END

Diagnosis Procedure

INFOID:000000006471936

1. CHECK DTC WITH "ABS ACTUATOR AND ELECTRIC UNIT"

Check "Self diagnosis result" using CONSULT-III. Refer to [BRC-103, "DTC Index"](#).

Is the inspection result normal?

- YES >> GO TO 2.
 NO >> Repair or replace the malfunctioning parts.

2. CHECK A/T SHIFT SELECTOR POWER SUPPLY

1. Turn ignition switch OFF.
2. Disconnect A/T shift selector (detention switch) connector.
3. Check voltage between A/T shift selector (detention switch) harness connector and ground.

(+)		(-)	Voltage (V) (Approx.)
Connector	Terminal		
M137	10	Ground	Battery voltage

Is the inspection result normal?

- YES >> GO TO 4.

B2602 SHIFT POSITION

< DTC/CIRCUIT DIAGNOSIS >

NO >> GO TO 3.

3.CHECK A/T SHIFT SELECTOR POWER SUPPLY CIRCUIT

1. Disconnect BCM connector.
2. Check continuity between A/T shift selector (detention switch) harness connector and BCM harness connector.

A/T shift selector (detention switch)		BCM		Continuity
Connector	Terminal	Connector	Terminal	
M137	10	M122	96	Existed

3. Check continuity between A/T shift selector (detention switch) harness connector and ground.

A/T shift selector (detention switch)		Ground	Continuity
Connector	Terminal		
M137	10		Not existed

Is the inspection result normal?

YES >> Replace BCM. Refer to [BCS-81. "Removal and Installation"](#).

NO >> Repair or replace harness.

4.CHECK A/T SHIFT SELECTOR CIRCUIT

1. Disconnect BCM connector and IPDM E/R connector.
2. Check continuity between A/T shift selector (detention switch) harness connector and BCM harness connector.

A/T shift selector (detention switch)		BCM		Continuity
Connector	Terminal	Connector	Terminal	
M137	11	M122	99	Existed

3. Check continuity between A/T shift selector (detention switch) harness connector and ground.

A/T shift selector (detention switch)		Ground	Continuity
Connector	Terminal		
M137	11		Not existed

Is the inspection result normal?

YES >> GO TO 5.

NO >> Repair or replace harness.

5.CHECK A/T SHIFT SELECTOR (DETENTION SWITCH)

Refer to [SEC-61. "Component Inspection"](#).

Is the inspection result normal?

YES >> GO TO 6.

NO >> Replace A/T shift selector. Refer to [TM-282. "Removal and Installation"](#).

6.CHECK INTERMITTENT INCIDENT

Refer to [GI-43. "Intermittent Incident"](#).

>> INSPECTION END

B2603 SHIFT POSITION

< DTC/CIRCUIT DIAGNOSIS >

B2603 SHIFT POSITION

Description

INFOID:000000006471937

BCM confirms the shift position with the following 4 signals.

- Selector lever
- Transmission range switch
- P position signal from IPDM E/R (CAN)
- P position signal from TCM (CAN)

DTC Logic

INFOID:000000006471938

DTC DETECTION LOGIC

NOTE:

- If DTC B2603 is displayed with DTC U1000, first perform the trouble diagnosis for DTC U1000. Refer to [BCS-35, "DTC Logic"](#).
- If DTC B2603 is displayed with DTC U1010, first perform the trouble diagnosis for DTC U1010. Refer to [BCS-36, "DTC Logic"](#).
- If DTC B2603 is displayed with DTC B2601, first perform the trouble diagnosis for DTC B2601. Refer to [SEC-59, "DTC Logic"](#).

DTC No.	Self-diagnosis name	DTC detecting condition	Possible causes
B2603	SHIFT POSI STATUS	BCM detects the following status for 500 ms or more when shift is in the P position, and ignition switch is in the ON position. <ul style="list-style-type: none">• Transmission range switch: approx. 0 V• A/T shift selector (detention switch): approx. 0 V	<ul style="list-style-type: none">• Harness or connector (A/T shift selector circuit is open or shorted)• Harness or connectors (TCM circuit is open or shorted)• A/T shift selector (detention switch)• TCM

DTC CONFIRMATION PROCEDURE

1. PERFORM DTC CONFIRMATION PROCEDURE

1. Start engine and wait 1 second or more.
2. Check "Self-diagnosis result" using CONSULT-III.

Is DTC detected?

- YES >> Go to [SEC-64, "Diagnosis Procedure"](#).
NO >> INSPECTION END

Diagnosis Procedure

INFOID:000000006471939

1. CHECK DTC WITH TCM

Check "Self diagnosis result" with CONSULT-III.

Are any DTC detected?

- YES >> Refer to [TM-258, "DTC Index"](#).
NO >> GO TO 2.

2. CHECK TRANSMISSION RANGE SWITCH CIRCUIT 1

1. Turn ignition switch OFF.
2. Disconnect A/T assembly connector and BCM connector.
3. Check continuity between A/T assembly harness connector and BCM harness connector.

A/T assembly		BCM		Continuity
Connector	Terminal	Connector	Terminal	
F51	9	M123	140	Existed

4. Check continuity between A/T assembly harness connector and ground.

B2603 SHIFT POSITION

< DTC/CIRCUIT DIAGNOSIS >

A/T assembly		Ground	Continuity
Connector	Terminal		
F51	9		Not existed

Is the inspection result normal?

YES >> GO TO 3.

NO >> Repair or replace harness.

3. CHECK TRANSMISSION RANGE SWITCH CIRCUIT 2

1. Disconnect TCM connector.
2. Check continuity between TCM harness connector and A/T assembly harness connector.

TCM		A/T assembly		Continuity
Connector	Terminal	Connector	Terminal	
F157	9	F51	9	Existed

3. Check continuity between TCM harness connector and ground.

TCM		Ground	Continuity
Connector	Terminal		
F157	9		Not existed

Is the inspection result normal?

YES >> GO TO 4.

NO >> Repair or replace harness.

4. CHECK A/T SHIFT SELECTOR POWER SUPPLY

1. Disconnect A/T shift selector (detention switch) connector.
2. Check voltage between A/T shift selector (detention switch) harness connector and ground.

(+)		(-)	Voltage (V) (Approx.)
A/T shift selector (detention switch)			
Connector	Terminal		
M137	10	Ground	Battery voltage

Is the inspection result normal?

YES >> GO TO 6.

NO >> GO TO 5.

5. CHECK A/T SHIFT SELECTOR POWER SUPPLY CIRCUIT

1. Disconnect BCM connector.
2. Check continuity between A/T shift selector (detention switch) harness connector and BCM harness connector.

A/T shift selector (detention switch)		BCM		Continuity
Connector	Terminal	Connector	Terminal	
M137	10	M122	96	Existed

3. Check continuity between A/T shift selector (detention switch) harness connector and ground.

A/T shift selector (detention switch)		Ground	Continuity
Connector	Terminal		
M137	10		Not existed

Is the inspection result normal?

YES >> Replace BCM. Refer to [BCS-81, "Removal and Installation"](#).

NO >> Repair or replace harness.

B2603 SHIFT POSITION

< DTC/CIRCUIT DIAGNOSIS >

6. CHECK A/T SHIFT SELECTOR CIRCUIT

1. Disconnect BCM connector and IPDM E/R connector.
2. Check continuity between A/T shift selector (detention switch) harness connector and BCM harness connector.

A/T shift selector (detention switch)		BCM		Continuity
Connector	Terminal	Connector	Terminal	
M137	11	M122	99	Existed

3. Check continuity between A/T shift selector (detention switch) harness connector and ground.

A/T shift selector (detention switch)		Ground	Continuity
Connector	Terminal		
M137	11		Not existed

Is the inspection result normal?

YES >> GO TO 7.

NO >> Repair or replace harness.

7. CHECK A/T SHIFT SELECTOR (DETENTION SWITCH)

Refer to [SEC-61. "Component Inspection"](#).

Is the inspection result normal?

YES >> GO TO 8.

NO >> Replace A/T shift selector. Refer to [TM-282. "Removal and Installation"](#).

8. CHECK INTERMITTENT INCIDENT

Refer to [GI-43. "Intermittent Incident"](#).

>> INSPECTION END

B2604 SHIFT POSITION

< DTC/CIRCUIT DIAGNOSIS >

B2604 SHIFT POSITION

Description

INFOID:000000006471940

BCM confirms the shift position with the following 4 signals.

- Selector lever
- Transmission range switch
- P position signal from IPDM E/R (CAN)
- P position signal from TCM (CAN)

DTC Logic

INFOID:000000006471941

DTC DETECTION LOGIC

NOTE:

- If DTC B2604 is displayed with DTC U1000, first perform the trouble diagnosis for DTC U1000. Refer to [BCS-35. "DTC Logic"](#).
- If DTC B2604 is displayed with DTC U1010, first perform the trouble diagnosis for DTC U1010. Refer to [BCS-36. "DTC Logic"](#).

DTC No.	Trouble diagnosis name	DTC detecting condition	Possible cause
B2604	PNP/CLUTCH SW	BCM detects the following status for 500 ms or more when the ignition switch is in the ON position. <ul style="list-style-type: none"> • N position input signal exists. Shift position signal from TCM does not exist. • N position input signal does not exist. Shift position signal from TCM exists. 	<ul style="list-style-type: none"> • Harness or connectors (TCM circuit is open or shorted) • TCM

DTC CONFIRMATION PROCEDURE

1. PERFORM DTC CONFIRMATION PROCEDURE

1. Start engine and wait 1 second or more.
2. Check "Self-diagnosis result" using CONSULT-III.

Is DTC detected?

- YES >> Go to [SEC-67. "Diagnosis Procedure"](#).
 NO >> INSPECTION END

Diagnosis Procedure

INFOID:000000006471942

1. CHECK DTC WITH TCM

Check "Self diagnosis result" using CONSULT-III.

Are any DTC detected?

- YES >> Refer to [TM-258. "DTC Index"](#).
 NO >> GO TO 2.

2. CHECK TRANSMISSION RANGE SWITCH CIRCUIT 1

1. Turn ignition switch OFF.
2. Disconnect A/T assembly connector and BCM connector.
3. Check continuity between A/T assembly harness connector and BCM harness connector.

A/T assembly		BCM		Continuity
Connector	Terminal	Connector	Terminal	
F51	9	M123	140	Existed

4. Check continuity between A/T assembly harness connector and ground.

A
B
C
D
E
F
G
H
I
J
L
M
N
O
P

SEC

B2604 SHIFT POSITION

< DTC/CIRCUIT DIAGNOSIS >

A/T assembly		Ground	Continuity
Connector	Terminal		
F51	9		Not existed

Is the inspection result normal?

YES >> GO TO 3.

NO >> Repair or replace harness.

3. CHECK TRANSMISSION RANGE SWITCH CIRCUIT 2

1. Disconnect TCM connector.
2. Check continuity between TCM harness connector and A/T assembly harness connector.

TCM		A/T assembly		Continuity
Connector	Terminal	Connector	Terminal	
F157	9	F51	9	Existed

3. Check continuity between TCM harness connector and ground.

TCM		Ground	Continuity
Connector	Terminal		
F157	9		Not existed

Is the inspection result normal?

YES >> GO TO 4.

NO >> Repair or replace harness.

4. CHECK INTERMITTENT INCIDENT

Refer to [GI-43. "Intermittent Incident"](#).

>> INSPECTION END

B2605 SHIFT POSITION

< DTC/CIRCUIT DIAGNOSIS >

B2605 SHIFT POSITION

Description

INFOID:000000006471943

BCM confirms the shift position with the following 4 signals.

- Selector lever
- Transmission range switch
- P position signal from IPDM E/R (CAN)
- P position signal from TCM (CAN)

DTC Logic

INFOID:000000006471944

DTC DETECTION LOGIC

NOTE:

- If DTC B2605 is displayed with DTC U1000, first perform the trouble diagnosis for DTC U1000. Refer to [BCS-35. "DTC Logic"](#).
- If DTC B2605 is displayed with DTC U1010, first perform the trouble diagnosis for DTC U1010. Refer to [BCS-36. "DTC Logic"](#).

DTC No.	Trouble diagnosis name	DTC detecting condition	Possible cause
B2605	PNP/CLUTCH SW	BCM detects the following status for 500 ms or more when the ignition switch is in the ON position <ul style="list-style-type: none">• N position input signal exists. Shift position signal from IPDM E/R does not exist.• N position input signal does not exist. Shift position signal from IPDM E/R exists.	<ul style="list-style-type: none">• Harness or connectors (TCM circuit is open or shorted)• TCM• IPDM E/R

DTC CONFIRMATION PROCEDURE

1. PERFORM DTC CONFIRMATION PROCEDURE

1. Turn ignition switch ON under the following conditions and wait 1 second or more.
 - Selector lever is in the P or N position
 - Do not depress brake pedal
2. Check "Self-diagnosis result" using CONSULT-III.

Is DTC detected?

YES >> Go to [SEC-69. "Diagnosis Procedure"](#).

NO >> INSPECTION END

Diagnosis Procedure

INFOID:000000006471945

1. CHECK DTC WITH IPDM E/R

Check "Self diagnosis result" using CONSULT-III. Refer to [PCS-31. "DTC Index"](#).

Is the inspection result normal?

YES >> GO TO 2.

NO >> Repair or replace the malfunctioning parts.

2. CHECK TRANSMISSION RANGE SWITCH CIRCUIT 1

1. Turn ignition switch OFF.
2. Disconnect A/T assembly connector and BCM connector.
3. Check continuity between A/T assembly harness connector and BCM harness connector.

A/T assembly		BCM		Continuity
Connector	Terminal	Connector	Terminal	
F51	9	M123	140	Existed

4. Check continuity between A/T assembly harness connector and ground.

B2605 SHIFT POSITION

< DTC/CIRCUIT DIAGNOSIS >

A/T assembly		Ground	Continuity
Connector	Terminal		
F51	9		Not existed

Is the inspection result normal?

YES >> GO TO 3.

NO >> Repair or replace harness.

3. CHECK TRANSMISSION RANGE SWITCH CIRCUIT 2

1. Disconnect TCM connector.
2. Check continuity between TCM harness connector and A/T assembly harness connector.

TCM		A/T assembly		Continuity
Connector	Terminal	Connector	Terminal	
F157	9	F51	9	Existed

3. Check continuity between TCM harness connector and ground.

TCM		Ground	Continuity
Connector	Terminal		
F157	9		Not existed

Is the inspection result normal?

YES >> GO TO 4.

NO >> Repair or replace harness.

4. CHECK INTERMITTENT INCIDENT

Refer to [GI-43. "Intermittent Incident"](#).

>> INSPECTION END

B2606 STEERING LOCK RELAY

< DTC/CIRCUIT DIAGNOSIS >

B2606 STEERING LOCK RELAY

Description

INFOID:000000006471946

The steering lock relay ON signal is transmitted to IPDM E/R by BCM via CAN communication. IPDM E/R turns the steering lock relay ON and transmits the release of the steering to BCM.

DTC Logic

INFOID:000000006471947

DTC DETECTION LOGIC

NOTE:

- If DTC B2606 is displayed with DTC U1000, first perform the trouble diagnosis for DTC U1000. Refer to [BCS-35, "DTC Logic"](#).
- If DTC B2606 is displayed with DTC U1010, first perform the trouble diagnosis for DTC U1010. Refer to [BCS-36, "DTC Logic"](#).

DTC No.	Trouble diagnosis name	DTC detecting condition	Possible cause
B2606	S/L RELAY	BCM detects that there is a discrepancy between the following statuses. <ul style="list-style-type: none">• Steering lock unit ON signal transmitted by IPDM E/R• The steering lock unit status feedback	Steering lock relay (In IPDM E/R)

DTC CONFIRMATION PROCEDURE

1. PERFORM DTC CONFIRMATION PROCEDURE

1. Turn ignition switch ON under the following conditions.

A/T models

- Selector lever is in the P or N position
- Do not depress brake pedal

M/T models

- Do not depress clutch pedal
2. Check "Self-diagnosis result" using CONSULT-III.

Is DTC detected?

- YES >> Go to [SEC-71, "Diagnosis Procedure"](#).
NO >> INSPECTION END

Diagnosis Procedure

INFOID:000000006471948

1. CHECK DTC WITH IPDM E/R

Check "Self-diagnosis result" using CONSULT-III. Refer to [PCS-31, "DTC Index"](#).

Is the inspection result normal?

- YES >> GO TO 2.
NO >> Replace IPDM E/R. Refer to [PCS-34, "Removal and Installation"](#).

2. CHECK INTERMITTENT INCIDENT

Refer to [GI-43, "Intermittent Incident"](#).

>> INSPECTION END

B2607 STEERING LOCK RELAY

< DTC/CIRCUIT DIAGNOSIS >

B2607 STEERING LOCK RELAY

Description

INFOID:000000006471949

BCM requests to IPDM E/R to supply power to steering lock unit. After receiving the power, the steering lock unit transmits an ON signal to BCM.

DTC Logic

INFOID:000000006471950

DTC DETECTION LOGIC

NOTE:

- If DTC B2607 is displayed with DTC U1000, first perform the trouble diagnosis for DTC U1000. Refer to [BCS-35, "DTC Logic"](#).
- If DTC B2607 is displayed with DTC U1010, first perform the trouble diagnosis for DTC U1010. Refer to [BCS-36, "DTC Logic"](#).

DTC No.	Trouble diagnosis name	DTC detecting condition	Possible cause
B2607	S/L RELAY	BCM detects that there is a difference between the following statuses. <ul style="list-style-type: none">• Steering lock unit ON signal transmitted by IPDM E/R• The steering lock unit status feedback	<ul style="list-style-type: none">• Harness or connectors (Steering lock unit power supply circuit is open or shorted)• Steering lock relay (In IPDM E/R)

DTC CONFIRMATION PROCEDURE

1. PERFORM DTC CONFIRMATION PROCEDURE

1. Turn ignition switch ON under the following conditions.

A/T models

- Selector lever is in the P or N position
- Do not depress brake pedal

M/T models

- Do not depress clutch pedal
2. Check "Self-diagnosis result" using CONSULT-III.

Is DTC detected?

- YES >> Go to [SEC-72, "Diagnosis Procedure"](#).
NO >> INSPECTION END

Diagnosis Procedure

INFOID:000000006471951

1. CHECK DTC WITH IPDM E/R

Check "Self-diagnosis result" using CONSULT-III. Refer to [PCS-31, "DTC Index"](#).

Is the inspection result normal?

- YES >> GO TO 2.
NO >> Repair or replace the malfunctioning parts.

2. CHECK STEERING LOCK UNIT POWER SUPPLY CIRCUIT

1. Turn ignition switch OFF.
2. Disconnect steering lock unit connector.
3. Check voltage between steering lock unit harness connector and ground.

(+)		(-)	Condition	Voltage (V) (Approx.)
Steering lock unit				
Connector	Terminal			
M40	1	Ground	Press push-button ignition switch when steering lock is in lock condition.	Battery voltage

Is the inspection result normal?

B2607 STEERING LOCK RELAY

< DTC/CIRCUIT DIAGNOSIS >

YES >> GO TO 4.

NO >> GO TO 3.

3. CHECK STEERING LOCK UNIT CIRCUIT

1. Disconnect IPDM E/R connector.
2. Check continuity between steering lock unit harness connector and IPDM E/R harness connector.

Steering lock unit		IPDM E/R		Continuity
Connector	Terminal	Connector	Terminal	
M40	1	E5	11	Existed

3. Check continuity between steering lock unit harness connector and ground.

Steering lock unit		Ground	Continuity
Connector	Terminal		
M40	1		Not existed

Is the inspection result normal?

YES >> Replace IPDM E/R. Refer to [PCS-34, "Removal and Installation"](#).

NO >> Repair or replace harness.

4. CHECK INTERMITTENT INCIDENT

Refer to [GI-43, "Intermittent Incident"](#).

>> INSPECTION END

A
B
C
D
E
F
G
H
I
J
L
M
N
O
P

SEC

B2608 STARTER RELAY

< DTC/CIRCUIT DIAGNOSIS >

B2608 STARTER RELAY

Description

INFOID:000000006471952

Located in IPDM E/R, the starter relay runs the starter motor. The starter relay is turned ON by the BCM when the ignition switch is in the START position. IPDM E/R transmits the starter relay ON signal to BCM via CAN communication.

DTC Logic

INFOID:000000006471953

DTC DETECTION LOGIC

NOTE:

- If DTC B2608 is displayed with DTC U1000, first perform the trouble diagnosis for DTC U1000. Refer to [BCS-35, "DTC Logic"](#).
- If DTC B2608 is displayed with DTC U1010, first perform the trouble diagnosis for DTC U1010. Refer to [BCS-36, "DTC Logic"](#).
- If DTC B2608 is displayed with DTC B210D for IPDM E/R, first perform the trouble diagnosis for DTC B210D. Refer to [SEC-107, "DTC Logic"](#).

DTC No.	Trouble diagnosis name	DTC detecting condition	Possible cause
B2608	STARTER RELAY	BCM receives starter relay ON signal (CAN) from IPDM E/R even if BCM turns the starter relay OFF.	<ul style="list-style-type: none">• Harness or connectors (Starter relay circuit is open or shorted.)• IPDM E/R

DTC CONFIRMATION PROCEDURE

1. PERFORM DTC CONFIRMATION PROCEDURE

1. Turn ignition switch ON under the following conditions.

A/T models

- Selector lever is in the P or N position
- Do not depress brake pedal

M/T models

- Do not depress clutch pedal
2. Check "Self-diagnosis result" using CONSULT-III.

Is DTC detected?

- YES >> Go to [SEC-74, "Diagnosis Procedure"](#).
NO >> INSPECTION END

Diagnosis Procedure

INFOID:000000006471954

1. CHECK BCM POWER SUPPLY CIRCUIT

1. Turn ignition switch ON.
2. Check voltage between BCM harness connector and ground.

(+)		(-)	Condition		Voltage (V) (Approx.)
BCM					
Connector	Terminal				
M121	52	Ground	Selector lever (A/T models)	N or P position	12
				Other than above	0
			Clutch pedal (M/T models)	Depressed	Battery voltage
				Not depressed	0

Is the measurement value within the specification?

- YES >> GO TO 3.
NO >> GO TO 2.

B2608 STARTER RELAY

< DTC/CIRCUIT DIAGNOSIS >

2. CHECK STARTER RELAY CIRCUIT

1. Turn ignition switch OFF.
2. Disconnect BCM connector and IPDM E/R connector.
3. Check continuity between IPDM E/R harness connector and BCM harness connector.

IPDM E/R		BCM		Continuity
Connector	Terminal	Connector	Terminal	
E6	46	M121	52	Existed

4. Check continuity between IPDM E/R harness connector and ground.

IPDM E/R		Ground	Continuity
Connector	Terminal		
E6	46		Not existed

Is the inspection result normal?

- YES >> Replace IPDM E/R. Refer to [PCS-34, "Removal and Installation"](#).
NO >> Repair or replace harness.

3. CHECK INTERMITTENT INCIDENT

Refer to [GI-43, "Intermittent Incident"](#).

>> INSPECTION END

A
B
C
D
E
F
G
H
I
J
L
M
N
O
P

SEC

B2609 STEERING STATUS

< DTC/CIRCUIT DIAGNOSIS >

B2609 STEERING STATUS

Description

INFOID:000000006471955

There are 2 switches in the steering lock unit (steering lock/unlock switch 1 and 2). BCM compares the 2 switch conditions to judge the present steering status.

DTC Logic

INFOID:000000006471956

DTC DETECTION LOGIC

NOTE:

- If DTC B2609 is displayed with DTC U1000, first perform the trouble diagnosis for DTC U1000. Refer to [PCS-15, "DTC Logic"](#).
- If DTC B2609 is displayed with DTC U1010, first perform the trouble diagnosis for DTC U1010. Refer to [BCS-36, "DTC Logic"](#).

DTC No.	Trouble diagnosis name	DTC detecting condition	Possible cause
B2609	S/L STATUS	BCM detects the malfunction of steering lock unit switches for 1 second.	<ul style="list-style-type: none">• Harness or connectors [Steering lock unit circuit (BCM side) is open or shorted]• Harness or connectors [Steering lock unit circuit (IPDM E/R side) is open or shorted]• Steering lock unit• IPDM E/R

DTC CONFIRMATION PROCEDURE

1. PERFORM DTC CONFIRMATION PROCEDURE-1

1. Turn ignition switch ON under the following conditions.

A/T models

- Selector lever is in the P or N position
- Do not depress brake pedal

M/T models

- Do not depress clutch pedal
2. Check "Self-diagnosis result" using CONSULT-III.

Is DTC detected?

- YES >> Go to [SEC-76, "Diagnosis Procedure"](#).
NO >> GO TO 2.

2. PERFORM DTC CONFIRMATION PROCEDURE-2

1. Turn ignition switch ON.
2. Turn ignition switch OFF.
3. Press driver side door switch and wait 1second or more.
4. Check "Self-diagnosis result" using CONSULT-III.

Is DTC detected?

- YES >> Go to [SEC-76, "Diagnosis Procedure"](#).
NO >> INSPECTION END

Diagnosis Procedure

INFOID:000000006471957

1. INSPECTION START

Perform inspection in accordance with procedure that confirms DTC.

Which procedure confirms DTC?

- DTC confirmation procedure 1>>GO TO 2.
DTC confirmation procedure 2>>GO TO 6.

B2609 STEERING STATUS

< DTC/CIRCUIT DIAGNOSIS >

2.CHECK BCM OUTPUT SIGNAL-1

1. Turn ignition switch OFF.
2. Disconnect steering lock unit connector and IPDM E/R connector.
3. Check voltage between steering lock unit harness connector and ground.

(+)		(-)	Voltage (V) (Approx.)
Steering lock unit			
Connector	Terminal		
M40	3	Ground	Battery voltage

Is the inspection result normal?

- YES >> GO TO 4.
NO >> GO TO 3.

3.CHECK STEERING LOCK UNIT CIRCUIT-1

1. Disconnect BCM connector.
2. Check continuity between steering lock unit harness connector and BCM harness connector.

Steering lock unit		BCM		Continuity
Connector	Terminal	Connector	Terminal	
M40	3	M122	97	Existed

3. Check continuity between steering lock unit harness connector and ground.

Steering lock unit		Ground	Continuity
Connector	Terminal		
M40	3		Not existed

Is the inspection result normal?

- YES >> Replace BCM. Refer to [BCS-81, "Removal and Installation"](#).
NO >> Repair or replace harness.

4.CHECK IPDM E/R OUTPUT SIGNAL-1

1. Connect IPDM E/R connector.
2. Disconnect BCM connector.
3. Check voltage between steering lock unit harness connector and ground.

(+)		(-)	Voltage (V) (Approx.)
Steering lock unit			
Connector	Terminal		
M40	3	Ground	Battery voltage

Is the inspection result normal?

- YES >> Replace steering lock unit.
NO >> GO TO 5.

5.CHECK STEERING LOCK UNIT CIRCUIT-2

1. Disconnect IPDM E/R connector.
2. Check continuity between steering lock unit harness connector and IPDM E/R harness connector.

Steering lock unit		IPDM E/R		Continuity
Connector	Terminal	Connector	Terminal	
M40	3	E5	32	Existed

3. Check continuity between steering lock unit harness connector and ground.

A
B
C
D
E
F
G
H
I
J
L
M
N
O
P

SEC

B2609 STEERING STATUS

< DTC/CIRCUIT DIAGNOSIS >

Steering lock unit		Ground	Continuity
Connector	Terminal		
M40	3		Not existed

Is the inspection result normal?

YES >> Replace IPDM E/R. Refer to [PCS-34, "Removal and Installation"](#).

NO >> Repair or replace harness.

6. CHECK BCM OUTPUT SIGNAL-2

1. Turn ignition switch OFF.
2. Disconnect steering lock unit connector and IPDM E/R connector.
3. Check voltage between steering lock unit harness connector and ground.

(+)		(-)	Voltage (V) (Approx.)
Steering lock unit			
Connector	Terminal		
M40	8	Ground	Battery voltage

Is the inspection result normal?

YES >> GO TO 8.

NO >> GO TO 7.

7. CHECK STEERING LOCK UNIT CIRCUIT-3

1. Disconnect BCM connector.
2. Check continuity between steering lock unit harness connector and BCM harness connector.

Steering lock unit		BCM		Continuity
Connector	Terminal	Connector	Terminal	
M40	8	M122	98	Existed

3. Check continuity between steering lock unit harness connector and ground.

Steering lock unit		Ground	Continuity
Connector	Terminal		
M40	8		Not existed

Is the inspection result normal?

YES >> Replace BCM. Refer to [BCS-81, "Removal and Installation"](#).

NO >> Repair or replace harness.

8. CHECK IPDM E/R OUTPUT SIGNAL-2

1. Connect IPDM E/R connector.
2. Disconnect BCM connector.
3. Check voltage between steering lock unit harness connector and ground.

(+)		(-)	Voltage (V) (Approx.)
Steering lock unit			
Connector	Terminal		
M40	8	Ground	Battery voltage

Is the inspection result normal?

YES >> Replace steering lock unit.

NO >> GO TO 9.

9. CHECK STEERING LOCK UNIT CIRCUIT-4

1. Disconnect IPDM E/R connector.
2. Check continuity between steering lock unit harness connector and IPDM E/R harness connector.

B2609 STEERING STATUS

< DTC/CIRCUIT DIAGNOSIS >

Steering lock unit		IPDM E/R		Continuity
Connector	Terminal	Connector	Terminal	
M40	8	E5	33	Existed

3. Check continuity between steering lock unit harness connector and ground.

Steering lock unit		Ground	Continuity
Connector	Terminal		
M40	8		Not existed

Is the inspection result normal?

- YES >> Replace IPDM E/R. Refer to [PCS-34, "Removal and Installation"](#).
 NO >> Repair or replace harness.

A
B
C
D
E
F
G
H
I
J
L
M
N
O
P

SEC

B260B STEERING LOCK UNIT

< DTC/CIRCUIT DIAGNOSIS >

B260B STEERING LOCK UNIT

Description

INFOID:000000006471958

The steering lock unit performs the check by itself according to the steering status.

DTC Logic

INFOID:000000006471959

DTC DETECTION LOGIC

DTC No.	Trouble diagnosis name	DTC detecting condition	Possible cause
B260B	STEERING LOCK UNIT	BCM detects malfunctioning of steering lock unit before steering unlocking.	Steering lock unit

DTC CONFIRMATION PROCEDURE

1. PERFORM DTC CONFIRMATION PROCEDURE

1. Press the push-button ignition switch, when steering is locked.
2. Check "Self-diagnosis result" using CONSULT-III.

Is DTC detected?

- YES >> Go to [SEC-80. "Diagnosis Procedure"](#).
NO >> INSPECTION END

Diagnosis Procedure

INFOID:000000006471960

1. INSPECTION START

1. Turn ignition switch ON.
2. Check "Self-diagnosis result" using CONSULT-III.
3. Touch "ERASE".
4. **Perform DTC Confirmation Procedure.**
See [SEC-80. "DTC Logic"](#).

Is the DTC B260B displayed again?

- YES >> Replace steering lock unit.
NO >> INSPECTION END

B260C STEERING LOCK UNIT

< DTC/CIRCUIT DIAGNOSIS >

B260C STEERING LOCK UNIT

Description

INFOID:000000006471961

The steering lock unit performs the check by itself according to the steering status.

DTC Logic

INFOID:000000006471962

DTC DETECTION LOGIC

DTC No.	Trouble diagnosis name	DTC detecting condition	Possible cause
B260C	STEERING LOCK UNIT	BCM detects malfunctioning of steering lock unit before steering locking.	Steering lock unit

DTC CONFIRMATION PROCEDURE

1. PERFORM DTC CONFIRMATION PROCEDURE

1. Turn ignition switch ON.
2. Turn ignition switch OFF.
3. Press driver side door switch.
4. Check "Self-diagnosis result" using CONSULT-III.

Is DTC detected?

- YES >> Go to [SEC-81. "Diagnosis Procedure"](#).
NO >> INSPECTION END

Diagnosis Procedure

INFOID:000000006471963

1. INSPECTION START

1. Turn ignition switch ON.
2. Check "Self-diagnosis result" using CONSULT-III.
3. Touch "ERASE".
4. **Perform DTC Confirmation Procedure.**
See [SEC-81. "DTC Logic"](#).

Is the DTC B260C displayed again?

- YES >> Replace steering lock unit.
NO >> INSPECTION END

A
B
C
D
E
F
G
H
I
J
L
M
N
O
P

SEC

B260D STEERING LOCK UNIT

< DTC/CIRCUIT DIAGNOSIS >

B260D STEERING LOCK UNIT

Description

INFOID:000000006471964

The steering lock unit performs the check by itself according to the steering lock status (before lock, after lock and unlock).

DTC Logic

INFOID:000000006471965

DTC DETECTION LOGIC

DTC No.	Trouble diagnosis name	DTC detecting condition	Possible cause
B260D	STEERING LOCK UNIT	BCM detects malfunctioning of steering lock unit after steering locking.	Steering lock unit

DTC CONFIRMATION PROCEDURE

1. PERFORM DTC CONFIRMATION PROCEDURE

1. Turn ignition switch ON.
2. Turn ignition switch OFF.
3. Press driver side door switch.
4. Check "Self-diagnosis result" using CONSULT-III.

Is DTC detected?

- YES >> Go to [SEC-82, "Diagnosis Procedure"](#).
NO >> INSPECTION END

Diagnosis Procedure

INFOID:000000006471966

1. INSPECTION START

1. Turn ignition switch ON.
2. Check "Self-diagnosis result" using CONSULT-III.
3. Touch "ERASE".
4. **Perform DTC Confirmation Procedure.**
See [SEC-82, "DTC Logic"](#).

Is the DTC B260D displayed again?

- YES >> Replace steering lock unit.
NO >> INSPECTION END

B260F ENGINE STATUS

< DTC/CIRCUIT DIAGNOSIS >

B260F ENGINE STATUS

Description

INFOID:000000006471967

BCM receives the engine status signal from ECM via CAN communication.

DTC Logic

INFOID:000000006471968

DTC DETECTION LOGIC

NOTE:

- If DTC B260F is displayed with DTC U1000, first perform the trouble diagnosis for DTC U1000. Refer to [BCS-35, "DTC Logic"](#).
- If DTC B260F is displayed with DTC U1010, first perform the trouble diagnosis for DTC U1010. Refer to [BCS-36, "DTC Logic"](#).

DTC No.	Trouble diagnosis name	DTC detecting condition	Possible cause
B260F	ENG STATE SIG LOST	BCM has not yet received the engine status signal from ECM when ignition switch is in the ON position.	ECM

DTC CONFIRMATION PROCEDURE

1. PERFORM DTC CONFIRMATION PROCEDURE

1. Turn ignition switch ON under the following conditions.

A/T models

- Selector lever is in the P or N position
- Do not depress brake pedal

M/T models

- Do not depress clutch pedal
2. Check "Self-diagnosis result" using CONSULT-III.

Is DTC detected?

- YES >> Go to [SEC-83, "Diagnosis Procedure"](#).
- NO >> INSPECTION END

Diagnosis Procedure

INFOID:000000006471969

SEC

1. INSPECTION START

1. Turn ignition switch ON.
2. Check "Self-diagnosis result" using CONSULT-III.
3. Touch "ERASE".
4. **Perform DTC Confirmation Procedure.**
See [SEC-83, "DTC Logic"](#).

Is the DTC B260F displayed again?

- YES >> GO TO 2.
- NO >> GO TO 3.

2. REPLACE ECM

Replace ECM. Refer to [EC-17, "ADDITIONAL SERVICE WHEN REPLACING CONTROL UNIT \(ECM\) : Special Repair Requirement"](#).

>> INSPECTION END

3. CHECK INTERMITTENT INCIDENT

Refer to [GI-43, "Intermittent Incident"](#).

>> INSPECTION END

B26E8 CLUTCH INTERLOCK SWITCH

< DTC/CIRCUIT DIAGNOSIS >

B26E8 CLUTCH INTERLOCK SWITCH

Description

INFOID:000000006471970

When clutch interlock switch turns ON, BCM detects that clutch pedal is being depressed and permits to start the engine.

DTC Logic

INFOID:000000006471971

NOTE:

If DTC B26E8 is displayed with DTC B210F, first perform the trouble diagnosis for DTC B210F. Refer to [SEC-110. "DTC Logic"](#).

DTC DETECTION LOGIC

DTC No.	Trouble diagnosis name	DTC detection condition	Possible cause
B26E8	CLUTCH SW	Detects that ASCD cancel switch is in the ON position for 2 seconds or more while ignition switch and clutch interlock switch are ON.	<ul style="list-style-type: none">Clutch interlock switchHarness or connector (Clutch interlock switch circuit open or shorted)

DTC CONFIRMATION PROCEDURE

1. PERFORM DTC CONFIRMATION PROCEDURE

- Turn ignition switch ON under the following condition.
 - Shift lever is in the neutral position.
 - Depress clutch pedal.
- Check "Self-diagnosis result" using CONSULT-III.

Is DTC detected?

- YES >> Go to [SEC-84. "Diagnosis Procedure"](#).
NO >> INSPECTION END

Diagnosis Procedure

INFOID:000000006471972

1. CHECK CLUTCH INTERLOCK SWITCH POWER SUPPLY

- Turn ignition switch OFF.
- Disconnect clutch interlock switch connector.
- Check voltage between clutch interlock switch harness connector and ground.

(+)		(-)	Voltage (V) (Approx.)
Clutch interlock switch			
Connector	Terminal		
E111	1	Ground	Battery voltage

Is the inspection result normal?

- YES >> GO TO 2.
NO-1 >> Check 10 A fuse [No. 9, located in the fuse block (J/B)]
NO-2 >> Check harness for open or short between clutch interlock switch and fuse.

2. CHECK CLUTCH INTERLOCK SWITCH SIGNAL

- Connect clutch interlock switch connector.
- Disconnect BCM connector.
- Check voltage between BCM harness connector and ground.

B26E8 CLUTCH INTERLOCK SWITCH

< DTC/CIRCUIT DIAGNOSIS >

(+)		(-)	Condition	Voltage (V) (Approx.)	
BCM					
Connector	Terminal				
M123	114	Ground	Clutch pedal	Depressed	Battery voltage
				Not depressed	0

Is the inspection result normal?

YES >> Replace BCM. Refer to [BCS-81, "Removal and Installation"](#).

NO >> GO TO 3.

3.CHECK CLUTCH INTERLOCK SWITCH SIGNAL CIRCUIT

1. Disconnect clutch interlock switch connector.
2. Check continuity between clutch interlock switch harness connector and BCM harness connector.

Clutch interlock switch		BCM		Continuity
Connector	Terminal	Connector	Terminal	
E111	2	M123	114	Existed

3. Check continuity between clutch interlock switch harness connector and ground.

Clutch interlock switch		Ground	Continuity
Connector	Terminal		
E111	2		Not existed

Is the inspection result normal?

YES >> GO TO 4.

NO >> Repair or replace harness.

4.CHECK CLUTCH INTERLOCK SWITCH

Refer to [SEC-85, "Component Inspection"](#).

Is the inspection result normal?

YES >> GO TO 5.

NO >> Replace clutch interlock switch. Refer to [CL-9, "Exploded View"](#).

5.CHECK INTERMITTENT INCIDENT

Refer to [GI-43, "Intermittent Incident"](#).

>> INSPECTION END

Component Inspection

INFOID:000000006471973

1.CHECK CLUTCH INTERLOCK SWITCH

1. Turn ignition switch OFF.
2. Disconnect clutch interlock switch connector.
3. Check continuity between clutch interlock switch terminals.

Clutch interlock switch		Condition	Continuity	
Terminal				
1	2	Clutch pedal	Depressed	Existed
			Not depressed	Not existed

Is the inspection result normal?

YES >> INSPECTION END

NO >> Replace clutch interlock switch. Refer to [CL-9, "Exploded View"](#).

B26E9 STEERING STATUS

< DTC/CIRCUIT DIAGNOSIS >

B26E9 STEERING STATUS

Description

INFOID:000000006471974

There are 2 switches in the steering lock unit (steering lock/unlock switch 1 and 2). BCM compares the 2 switch conditions to judge the present steering status.

DTC Logic

INFOID:000000006471975

DTC DETECTION LOGIC

NOTE:

If DTC B26E9 is displayed with DTC B2609, first perform the trouble diagnosis for DTC B2609. Refer to [SEC-76, "DTC Logic"](#).

DTC No.	Trouble diagnosis name	DTC detecting condition	Possible cause
B26E9	S/L STATUS	BCM requests lock to steering lock unit, then steering lock unit transmits a recognition signal to BCM, but steering lock unit remains unlocked.	Steering lock unit

DTC CONFIRMATION PROCEDURE

1. PERFORM DTC CONFIRMATION PROCEDURE

1. Turn ignition switch ON.
2. Turn ignition switch OFF.
3. Press driver side door switch and wait 1 second or more.
4. Turn ignition switch ON.
5. Check "Self-diagnosis result" using CONSULT-III.

Is DTC detected?

- YES >> Refer to [SEC-86, "Diagnosis Procedure"](#).
NO >> INSPECTION END

Diagnosis Procedure

INFOID:000000006471976

1. INSPECTION START

1. Turn ignition switch ON.
2. Check "Self-diagnosis result" using CONSULT-III.
3. Touch "ERASE".
4. Perform DTC Confirmation Procedure.
Refer to [SEC-86, "DTC Logic"](#).

Is the DTC B26E9 displayed again?

- YES >> GO TO 2.
NO >> GO TO 3.

2. REPLACE STEERING LOCK UNIT

1. Replace steering lock unit.
2. Perform DTC confirmation procedure. Refer to [SEC-86, "DTC Logic"](#).

Is the DTC B26E9 displayed again?

- YES >> GO TO 3.
NO >> INSPECTION END

3. CHECK INTERMITTENT INCIDENT

Refer to [GI-43, "Intermittent Incident"](#).

>> INSPECTION END

B26EA KEY REGISTRATION

< DTC/CIRCUIT DIAGNOSIS >

B26EA KEY REGISTRATION

Description

INFOID:000000006471977

When the registered Intelligent Key is carried, the door lock/unlock operation and the push-button ignition switch operation become possible.

DTC Logic

INFOID:000000006471978

DTC DETECTION LOGIC

DTC No.	Trouble diagnosis name	DTC detecting condition	Possible cause
B26EA	KEY REGISTRATION	Intelligent Key is not registered successfully.	<ul style="list-style-type: none">Improper registration operationIntelligent KeyBCM

DTC CONFIRMATION PROCEDURE

1. PERFORM DTC CONFIRMATION PROCEDURE

1. Perform initialization using CONSULT-III. Reregister all Intelligent Keys.
For initialization and registration of Intelligent Key, refer to "CONSULT-III Operation Manual NATS-IVIS/NVIS".
2. Check "Self-diagnosis result" using CONSULT-III.

Is DTC detected?

- YES >> Go to [SEC-87. "Diagnosis Procedure"](#)
NO >> INSPECTION END

Diagnosis Procedure

INFOID:000000006471979

1. PERFORM INITIALIZATION

1. Perform initialization using CONSULT-III. Reregister all Intelligent Keys.
For initialization and registration of Intelligent Key, refer to "CONSULT-III Operation Manual NATS-IVIS/NVIS".
2. Check "Self-diagnosis result" using CONSULT-III.

Is DTC detected?

- YES >> GO TO 2.
NO >> INSPECTION END

2. REPLACE INTELLIGENT KEY

1. Replace Intelligent Key. Reregister all Intelligent Keys
2. Perform initialization using CONSULT-III. For initialization, refer to "CONSULT-III Operation Manual NATS-IVIS/NVIS".
3. Check "Self-diagnosis result" using CONSULT-III.

Is DTC detected?

- YES >> Replace BCM. Refer to [BCS-81. "Removal and Installation"](#).
NO >> INSPECTION END

B2612 STEERING STATUS

< DTC/CIRCUIT DIAGNOSIS >

B2612 STEERING STATUS

Description

INFOID:000000006471980

There are 2 switches in the steering unit. IPDM E/R compares the 2 switch conditions to judge the present steering status and transmits the result to BCM via CAN communication.

DTC Logic

INFOID:000000006471981

DTC DETECTION LOGIC

NOTE:

- If DTC B2612 is displayed with DTC U1000, first perform the trouble diagnosis for DTC U1000. Refer to [BCS-35, "DTC Logic"](#).
- If DTC B2612 is displayed with DTC U1010, first perform the trouble diagnosis for DTC U1010. Refer to [BCS-36, "DTC Logic"](#).

DTC No.	Self-diagnosis name	DTC detecting condition	Possible causes
B2612	S/L STATUS	BCM detects the difference between the following status for 1 second <ul style="list-style-type: none">• Steering lock or unlock• Feedback of steering lock status from IPDM E/R (CAN)	<ul style="list-style-type: none">• Harness or connectors [Steering lock unit circuit (BCM side) is open or shorted]• Harness or connectors [Steering lock unit circuit (IPDM E/R side) is open or shorted]• Steering lock unit• IPDM E/R

DTC CONFIRMATION PROCEDURE

1. PERFORM DTC CONFIRMATION PROCEDURE-1

1. Turn ignition switch ON under the following conditions.

A/T models

- Selector lever is in the P or N position
- Do not depress brake pedal

M/T models

- Do not depress clutch pedal
2. Check "Self-diagnosis result" using CONSULT-III.

Is DTC detected?

- YES >> Go to [SEC-88, "Diagnosis Procedure"](#).
NO >> GO TO 2.

2. PERFORM DTC CONFIRMATION PROCEDURE-2

1. Turn ignition switch ON.
2. Turn ignition switch OFF.
3. Press door switch.
4. Check "Self-diagnosis result" using CONSULT-III.

Is DTC detected?

- YES >> Go to [SEC-88, "Diagnosis Procedure"](#).
NO >> INSPECTION END

Diagnosis Procedure

INFOID:000000006471982

1. INSPECTION START

Perform inspection in accordance with procedure that confirms DTC.

Which procedure confirms DTC?

- DTC confirmation procedure 1 >> GO TO 2.
DTC confirmation procedure 2 >> GO TO 6.

2. CHECK BCM OUTPUT SIGNAL-1

B2612 STEERING STATUS

< DTC/CIRCUIT DIAGNOSIS >

1. Turn ignition switch OFF.
2. Disconnect steering lock unit connector and IPDM E/R connector.
3. Check voltage between steering lock unit harness connector and ground.

(+)		(-)	Voltage (V) (Approx.)
Steering lock unit			
Connector	Terminal	Ground	Battery voltage
M40	3		

Is the inspection result normal?

- YES >> GO TO 4.
NO >> GO TO 3.

3.CHECK STEERING LOCK UNIT CIRCUIT-1

1. Disconnect BCM connector.
2. Check continuity between steering lock unit harness connector and BCM harness connector.

Steering lock unit		BCM		Continuity
Connector	Terminal	Connector	Terminal	
M40	3	M122	97	Existed

3. Check continuity between steering lock unit harness connector and ground.

Steering lock unit		Ground	Continuity
Connector	Terminal		
M40	3		Not existed

Is the inspection result normal?

- YES >> Replace BCM. Refer to [BCS-81, "Removal and Installation"](#).
NO >> Repair or replace harness.

4.CHECK IPDM E/R OUTPUT SIGNAL-1

1. Connect IPDM E/R connector.
2. Disconnect BCM connector.
3. Check voltage between steering lock unit harness connector and ground.

(+)		(-)	Voltage (V) (Approx.)
Steering lock unit			
Connector	Terminal	Ground	Battery voltage
M40	3		

Is the inspection result normal?

- YES >> Replace steering lock unit.
NO >> GO TO 5.

5.CHECK STEERING LOCK UNIT CIRCUIT-2

1. Disconnect IPDM E/R connector.
2. Check continuity between steering lock unit harness connector and IPDM E/R harness connector.

Steering lock unit		IPDM E/R		Continuity
Connector	Terminal	Connector	Terminal	
M40	3	E5	32	Existed

3. Check continuity between steering lock unit harness connector and ground.

Steering lock unit		Ground	Continuity
Connector	Terminal		
M40	3		Not existed

A

B

C

D

E

F

G

H

I

J

SEC

L

M

N

O

P

B2612 STEERING STATUS

< DTC/CIRCUIT DIAGNOSIS >

Is the inspection result normal?

YES >> Replace IPDM E/R. Refer to [PCS-34, "Removal and Installation"](#).

NO >> Repair or replace harness.

6.CHECK BCM OUTPUT SIGNAL-2

1. Turn ignition switch OFF.
2. Disconnect steering lock unit connector and IPDM E/R connector.
3. Check voltage between steering lock unit harness connector and ground.

(+)		(-)	Voltage (V) (Approx.)
Steering lock unit			
Connector	Terminal	Ground	Battery voltage
M40	8		

Is the inspection result normal?

YES >> GO TO 8.

NO >> GO TO 7.

7.CHECK STEERING LOCK UNIT CIRCUIT-3

1. Disconnect BCM connector.
2. Check continuity between steering lock unit harness connector and BCM harness connector.

Steering lock unit		BCM		Continuity
Connector	Terminal	Connector	Terminal	
M40	8	M122	98	Existed

3. Check continuity between steering lock unit harness connector and ground.

Steering lock unit		Ground	Continuity
Connector	Terminal		
M40	8	Not existed	

Is the inspection result normal?

YES >> Replace BCM. Refer to [BCS-81, "Removal and Installation"](#).

NO >> Repair or replace harness.

8.CHECK IPDM E/R OUTPUT SIGNAL-2

1. Connect IPDM E/R connector.
2. Disconnect BCM connector.
3. Check voltage between steering lock unit harness connector and ground.

(+)		(-)	Voltage (V) (Approx.)
Steering lock unit			
Connector	Terminal	Ground	Battery voltage
M40	8		

Is the inspection result normal?

YES >> Replace steering lock unit.

NO >> GO TO 9.

9.CHECK STEERING LOCK UNIT CIRCUIT-4

1. Disconnect IPDM E/R connector.
2. Check continuity between steering lock unit harness connector and IPDM E/R harness connector.

Steering lock unit		IPDM E/R		Continuity
Connector	Terminal	Connector	Terminal	
M40	8	E5	33	Existed

B2612 STEERING STATUS

< DTC/CIRCUIT DIAGNOSIS >

3. Check continuity between steering lock unit harness connector and ground.

Steering lock unit		Ground	Continuity
Connector	Terminal		
M40	8		Not existed

Is the inspection result normal?

YES >> Replace IPDM E/R. Refer to [PCS-34, "Removal and Installation"](#).

NO >> Repair or replace harness.

A

B

C

D

E

F

G

H

I

J

SEC

L

M

N

O

P

B2617 STARTER RELAY CIRCUIT

< DTC/CIRCUIT DIAGNOSIS >

B2617 STARTER RELAY CIRCUIT

Description

INFOID:000000006471983

Located in IPDM E/R, the starter relay runs the starter motor. The starter relay is turned ON by the BCM when the ignition switch is in the START position. IPDM E/R transmits the starter relay ON signal to BCM via CAN communication.

DTC Logic

INFOID:000000006471984

DTC DETECTION LOGIC

NOTE:

- If DTC B2617 is displayed with DTC U1000, first perform the trouble diagnosis for DTC U1000. Refer to [PCS-15, "DTC Logic"](#).
- If DTC B2617 is displayed with DTC U1010, first perform the trouble diagnosis for DTC U1010. Refer to [BCS-36, "DTC Logic"](#).
- If DTC B2617 is displayed with DTC B210E for IPDM E/R, first perform the trouble diagnosis for DTC B210E. Refer to [SEC-108, "DTC Logic"](#).

DTC No.	Trouble diagnosis name	DTC detecting condition	Possible cause
B2617	BCM	An immediate operation of starter relay is requested by BCM, but there is no response for more than 1 second.	<ul style="list-style-type: none">• Harness or connectors (Starter relay circuit is open or shorted.)• IPDM E/R

DTC CONFIRMATION PROCEDURE

1. PERFORM DTC CONFIRMATION PROCEDURE

1. Turn ignition switch ON under the following conditions and wait 1 second or more.

A/T models

- Selector lever is in the P or N position
- Do not depress brake pedal

M/T models

- Do not depress clutch pedal
2. Check "Self-diagnosis result" using CONSULT-III.

Is DTC detected?

- YES >> Go to [SEC-92, "Diagnosis Procedure"](#).
NO >> INSPECTION END

Diagnosis Procedure

INFOID:000000006471985

1. CHECK STARTER RELAY

1. Turn ignition switch ON.
2. Check voltage between BCM harness connector and ground.

(+)		(-)	Condition		Voltage (V) (Approx.)
BCM					
Connector	Terminal	Ground			
M121	52		Selector lever (A/T models)	N or P position	12
				Other than above	0
			Clutch pedal (M/T models)	Depressed	Battery voltage
		Not depressed		0	

Is the measurement value within the specification.

- YES >> GO TO 3.
NO >> GO TO 2.

B2617 STARTER RELAY CIRCUIT

< DTC/CIRCUIT DIAGNOSIS >

2. CHECK STARTER RELAY CIRCUIT

1. Turn ignition switch OFF.
2. Disconnect BCM connector and IPDM E/R connector.
3. Check continuity between IPDM E/R harness connector and BCM harness connector.

IPDM E/R		BCM		Continuity
Connector	Terminal	Connector	Terminal	
E6	46	M121	52	Existed

4. Check continuity between IPDM E/R harness connector and ground.

IPDM E/R		Ground	Continuity
Connector	Terminal		
E6	46		Not existed

Is the inspection result normal?

- YES >> Replace IPDM E/R. Refer to [PCS-34, "Removal and Installation"](#).
NO >> Repair or replace harness.

3. CHECK INTERMITTENT INCIDENT

Refer to [GI-43, "Intermittent Incident"](#).

>> INSPECTION END

A
B
C
D
E
F
G
H
I
J
L
M
N
O
P

SEC

B2619 BCM

< DTC/CIRCUIT DIAGNOSIS >

B2619 BCM

Description

INFOID:000000006471986

BCM requests IPDM E/R to supply power to steering lock unit. After receiving the power, the steering lock unit transmits an ON signal to BCM.

DTC Logic

INFOID:000000006471987

DTC DETECTION LOGIC

DTC No.	Trouble diagnosis name	DTC detecting condition	Possible cause
B2619	BCM	BCM detects a discrepancy between the power supplied to the steering lock unit and the feedback for one second or more.	BCM

DTC CONFIRMATION PROCEDURE

1. PERFORM DTC CONFIRMATION PROCEDURE

1. Turn ignition switch ON under the following conditions and wait 1 second or more.

A/T models

- Selector lever is in the P or N position
- Do not depress brake pedal

M/T models

- Do not depress clutch pedal
2. Check "Self-diagnosis result" using CONSULT-III.

Is DTC detected?

- YES >> Go to [SEC-94. "Diagnosis Procedure"](#).
NO >> INSPECTION END

Diagnosis Procedure

INFOID:000000006471988

1. INSPECTION START

1. Turn ignition switch ON.
2. Check "Self-diagnosis result" using CONSULT-III.
3. Touch "ERASE".
4. **Perform DTC Confirmation Procedure.**
See [SEC-94. "DTC Logic"](#).

Is the DTC B2619 displayed again?

- YES >> Replace BCM. Refer to [BCS-81. "Removal and Installation"](#).
NO >> INSPECTION END

B261E VEHICLE TYPE

< DTC/CIRCUIT DIAGNOSIS >

B261E VEHICLE TYPE

Description

INFOID:000000006471989

There are two types of vehicles.

- HEV
- Conventional

DTC Logic

INFOID:000000006471990

DTC DETECTION LOGIC

NOTE:

- If DTC B261E is displayed with DTC U1000, first perform the trouble diagnosis for DTC U1000. Refer to [BCS-35, "DTC Logic"](#).
- If DTC B261E is displayed with DTC U1010, first perform the trouble diagnosis for DTC U1010. Refer to [BCS-36, "DTC Logic"](#).

DTC No.	Trouble diagnosis name	DTC detecting condition	Possible cause
B261E	VEHICLE TYPE	Difference of BCM configuration.	BCM

DTC CONFIRMATION PROCEDURE

1. PERFORM DTC CONFIRMATION PROCEDURE

1. Turn ignition switch ON under the following conditions.

A/T models

- Selector lever is in the P or N position
- Do not depress brake pedal

M/T models

- Do not depress clutch pedal
2. Check "Self-diagnosis result" using CONSULT-III.

Is DTC detected?

- YES >> Go to [SEC-95, "Diagnosis Procedure"](#).
NO >> INSPECTION END

Diagnosis Procedure

INFOID:000000006471991

1. INSPECTION START

1. Turn ignition switch ON.
2. Check "Self-diagnosis result" using CONSULT-III.
3. Touch "ERASE".
4. **Perform DTC Confirmation Procedure.**
See [SEC-95, "DTC Logic"](#).

Is the 1st trip DTC B261E displayed again?

- YES >> Replace BCM. Refer to [BCS-81, "Removal and Installation"](#).
NO >> INSPECTION END

B261F ASCD CLUTCH SWITCH

< DTC/CIRCUIT DIAGNOSIS >

B261F ASCD CLUTCH SWITCH

Description

INFOID:000000006471992

BCM judges that clutch pedal is operated by clutch interlock switch and clutch pedal position switch operation.

DTC Logic

INFOID:000000006471993

DTC DETECTION LOGIC

DTC No.	Trouble diagnosis name	DTC detection condition	Possible cause
B261F	ASCD CNCL/CLTCH SW	When ignition switch is ON and vehicle speed is 40 km/h, BCM detects that clutch pedal position switch is ON for 10 seconds or more.	<ul style="list-style-type: none"> Harness or connector (ASCD clutch switch circuit open or shorted) Clutch pedal position switch BCM

DTC CONFIRMATION PROCEDURE

1. PERFORM DTC CONFIRMATION PROCEDURE

1. Drive the vehicle at the vehicle speed of 40 km/h (24.8 MPH) or more wait 10 seconds or more.
2. Check "Self-diagnosis result" using CONSULT-III.

Is DTC detected?

- YES >> Go to [SEC-96. "Diagnosis Procedure"](#).
 NO >> INSPECTION END

Diagnosis Procedure

INFOID:000000006471994

1. CHECK ASCD CLUTCH SWITCH POWER SUPPLY

1. Turn ignition switch OFF.
2. Disconnect ASCD clutch switch connector.
3. Turn ignition switch ON.
4. Check voltage between ASCD clutch switch harness connector and ground.

(+)		(-)	Voltage (V) (Approx.)
ASCD clutch switch			
Connector	Terminal	Ground	Battery voltage
E108	1		

Is the inspection result normal?

- YES >> GO TO 2.
 NO-1 >> Check ASCD brake switch. Refer to [EC-500. "Component Function Check"](#).
 NO-2 >> Check 10A fuse [No. 3, located in the fuse block (J/B)]
 NO-3 >> Check harness for open or short between ASCD clutch switch and fuse.

2. CHECK ASCD CLUTCH SWITCH SIGNAL

1. Turn ignition switch OFF.
2. Connect ASCD clutch switch connector.
3. Disconnect BCM connector.
4. Check voltage between BCM harness connector and ground.

(+)		(-)	Condition	Voltage (V) (Approx.)
BCM				
Connector	Terminal	Ground	Clutch pedal	0 Battery voltage
M122	99			
			Not depressed	Battery voltage

Is the inspection result normal?

B261F ASCD CLUTCH SWITCH

< DTC/CIRCUIT DIAGNOSIS >

- YES >> Replace BCM. Refer to [BCS-81, "Removal and Installation"](#).
 NO >> GO TO 3.

3.CHECK ASCD CLUTCH SWITCH SIGNAL CIRCUIT

1. Disconnect ASCD clutch switch connector.
2. Check continuity between ASCD clutch switch harness connector and BCM harness connector.

ASCD clutch switch		BCM		Continuity
Connector	Terminal	Connector	Terminal	
E108	2	M122	99	Existed

3. Check continuity between ASCD clutch switch harness connector and ground.

ASCD clutch switch		Ground	Continuity
Connector	Terminal		
E108	2		Not existed

Is the inspection result normal?

- YES >> GO TO 4.
 NO >> Repair or replace harness.

4.CHECK ASCD CLUTCH SWITCH

Refer to [SEC-97, "Component Inspection"](#).

Is the inspection result normal?

- YES >> GO TO 5.
 NO >> Replace ASCD clutch switch. Refer to [CL-9, "Exploded View"](#).

5.CHECK INTERMITTENT INCIDENT

Refer to [GI-43, "Intermittent Incident"](#).

>> INSPECTION END

Component Inspection

INFOID:000000006471995

1.CHECK ASCD CLUTCH SWITCH

1. Turn ignition switch OFF.
2. Disconnect ASCD clutch switch connector.
3. Check continuity between ASCD clutch switch terminals.

ASCD clutch switch		Condition	Continuity
Terminal			
1	2	Clutch pedal Depressed	Not existed
		Clutch pedal Not depressed	Existed

Is the inspection result normal?

- YES >> INSPECTION END
 NO >> Replace ASCD clutch switch. Refer to [CL-9, "Exploded View"](#).

B2108 STEERING LOCK RELAY

< DTC/CIRCUIT DIAGNOSIS >

B2108 STEERING LOCK RELAY

Description

INFOID:000000006471996

The steering lock relay ON signal is transmitted to IPDM E/R by BCM via CAN communication. IPDM E/R turns the steering lock relay ON and transmits the release of the steering to BCM.

DTC Logic

INFOID:000000006471997

DTC DETECTION LOGIC

NOTE:

If DTC B2108 is displayed with DTC U1000, first perform the trouble diagnosis for DTC U1000. Refer to [PCS-15, "DTC Logic"](#).

DTC No.	Trouble diagnosis name	DTC detecting condition	Possible cause
B2108	STRG LCK RELAY ON	IPDM E/R detects that the relay is stuck in the ON position for about 1 second even if the IPDM E/R receives steering lock relay ON/OFF signal from BCM.	IPDM E/R

DTC CONFIRMATION PROCEDURE

1. PERFORM DTC CONFIRMATION PROCEDURE

1. Turn ignition switch ON under the following conditions and wait 1 second or more.

A/T models

- Selector lever is in the P or N position
- Do not depress brake pedal

M/T models

- Do not depress clutch pedal
2. Check "Self-diagnosis result" using CONSULT-III.

Is DTC detected?

- YES >> Go to [SEC-98, "Diagnosis Procedure"](#).
NO >> INSPECTION END

Diagnosis Procedure

INFOID:000000006471998

1. CHECK STEERING LOCK RELAY

Check voltage between IPDM E/R harness connector and ground.

(+)		(-)	Condition		Voltage (V) (Approx.)
IPDM E/R					
Connector	Terminal				
E5	11	Ground	Ignition switch OFF	A few seconds after opening the driver door	Battery voltage
			Ignition switch LOCK	Press the push-button ignition switch	Battery voltage
			Ignition switch ACC or ON		0

Is the inspection normal?

- YES >> GO TO 2.
NO >> Replace IPDM E/R. Refer to [PCS-34, "Removal and Installation"](#).

2. CHECK STEERING LOCK RELAY CIRCUIT

1. Turn ignition switch OFF.
2. Disconnect IPDM E/R connector and steering lock unit connector.
3. Check continuity IPDM E/R harness connector and steering lock unit harness connector.

B2108 STEERING LOCK RELAY

< DTC/CIRCUIT DIAGNOSIS >

IPDM E/R		Steering lock unit		Continuity
Connector	Terminal	Connector	Terminal	
E5	11	M40	1	Existed

4. Check continuity IPDM E/R harness connector and ground.

IPDM E/R		Ground	Continuity
Connector	Terminal		
E5	11		Not existed

Is the inspection result normal?

YES >> GO TO 3.

NO >> Repair or replace harness.

3. CHECK INTERMITTENT INCIDENT

Refer to [GI-43, "Intermittent Incident"](#).

>> INSPECTION END

A
B
C
D
E
F
G
H
I
J
L
M
N
O
P

SEC

B2109 STEERING LOCK RELAY

< DTC/CIRCUIT DIAGNOSIS >

B2109 STEERING LOCK RELAY

Description

INFOID:000000006471999

The steering lock relay ON signal is transmitted to IPDM E/R by BCM via CAN communication. IPDM E/R turns the steering lock relay ON and transmits the release of the steering to BCM.

DTC Logic

INFOID:000000006472000

DTC DETECTION LOGIC

NOTE:

- If DTC B2109 is displayed with DTC U1000, first perform the trouble diagnosis for DTC U1000. Refer to [PCS-15, "DTC Logic"](#).
- When IPDM E/R power supply voltage is low (Approx. 7 - 8 V for about 1 second), the DTC B2109 may be detected.

DTC No.	Trouble diagnosis name	DTC detecting condition	Possible cause
B2109	STRG LCK RELAY OFF	IPDM E/R detects that the relay is stuck in the OFF position for about 1 second even if the IPDM E/R receives steering lock relay ON/OFF signal from BCM.	<ul style="list-style-type: none">• Harness or connector (Power supply circuit)• IPDM E/R• Battery

DTC CONFIRMATION PROCEDURE

1. PERFORM DTC CONFIRMATION PROCEDURE

1. Turn ignition switch ON under the following conditions and wait 1 second or more.

A/T models

- Selector lever is in the P or N position
- Do not depress brake pedal

M/T models

- Do not depress clutch pedal
2. Check "Self-diagnosis result" using CONSULT-III.

Is DTC detected?

- YES >> Go to [SEC-100, "Diagnosis Procedure"](#).
NO >> INSPECTION END

Diagnosis Procedure

INFOID:000000006472001

1. CHECK POWER SUPPLY CIRCUIT

Check IPDM E/R power supply circuit. Refer to [SEC-114, "IPDM E/R : Diagnosis Procedure"](#).

Is the circuit normal?

- YES >> GO TO 2.
NO >> Repair or replace the malfunctioning part.

2. CHECK FUSE

1. Turn ignition switch OFF.
2. Check 10A fuse (No. 48, located in IPDM E/R).

Is the inspection normal?

- YES >> Replace IPDM E/R. Refer to [PCS-34, "Removal and Installation"](#).
NO >> Replace the blown fuse after repairing the affected circuit if a fuse is blown.

B210A STEERING LOCK UNIT

< DTC/CIRCUIT DIAGNOSIS >

B210A STEERING LOCK UNIT

Description

INFOID:000000006472002

There are 2 switches in the steering unit. IPDM E/R compares the 2 switch conditions to judge the present steering status and transmits the result to BCM via CAN communication.

DTC Logic

INFOID:000000006472003

DTC DETECTION LOGIC

NOTE:

If DTC B210A is displayed with DTC U1000, first perform the trouble diagnosis for DTC U1000. Refer to [PCS-15, "DTC Logic"](#).

DTC No.	Trouble diagnosis name	DTC detecting condition	Possible cause
B210A	STRG LCK STATE SW	IPDM E/R detects the difference between steering condition switches 1 and 2 for 1 second.	<ul style="list-style-type: none">• Harness or connectors [Steering lock unit circuit (BCM side) is open or shorted]• Harness or connectors [Steering lock unit circuit (IPDM E/R side) is open or shorted]• Steering lock unit• IPDM E/R

DTC CONFIRMATION PROCEDURE

1.PERFORM DTC CONFIRMATION PROCEDURE-1

1. Turn ignition switch ON under the following conditions and wait 1 second or more.

A/T models

- Selector lever is in the P or N position
- Do not depress brake pedal

M/T models

- Do not depress clutch pedal
2. Check "Self-diagnosis result" using CONSULT-III.

Is DTC detected?

- YES >> Go to [SEC-101, "Diagnosis Procedure"](#).
NO >> GO TO 2.

2.PERFORM DTC CONFIRMATION PROCEDURE-2

1. Turn ignition switch ON.
2. Turn ignition switch OFF.
3. Press driver side door switch and wait 1 second or more.
4. Check "Self-diagnosis result" using CONSULT-III.

Is DTC detected?

- YES >> Go to [SEC-101, "Diagnosis Procedure"](#).
NO >> INSPECTION END

Diagnosis Procedure

INFOID:000000006472004

1.INSPECTION START

Perform inspection in accordance with procedure that confirms DTC.

Which procedure confirms DTC?

- DTC confirmation procedure 1>>GO TO 2.
DTC confirmation procedure 2>>GO TO 6.

2.CHECK BCM OUTPUT SIGNAL-1

1. Turn ignition switch OFF.

B210A STEERING LOCK UNIT

< DTC/CIRCUIT DIAGNOSIS >

2. Disconnect steering lock unit connector and IPDM E/R connector.
3. Check voltage between steering lock unit harness connector and ground.

(+)		(-)	Voltage (V) (Approx.)
Steering lock unit			
Connector	Terminal		
M40	3	Ground	Battery voltage

Is the inspection result normal?

- YES >> GO TO 4.
 NO >> GO TO 3.

3.CHECK STEERING LOCK UNIT CIRCUIT-1

1. Disconnect BCM connector.
2. Check continuity between steering lock unit harness connector and BCM harness connector.

Steering lock unit		BCM		Continuity
Connector	Terminal	Connector	Terminal	
M40	3	M122	97	Existed

3. Check continuity between steering lock unit harness connector and ground.

Steering lock unit		Ground	Continuity
Connector	Terminal		
M40	3		Not existed

Is the inspection result normal?

- YES >> Replace BCM. Refer to [BCS-81, "Removal and Installation"](#).
 NO >> Repair or replace harness.

4.CHECK IPDM E/R OUTPUT SIGNAL-1

1. Connect IPDM E/R connector.
2. Disconnect BCM connector.
3. Check voltage between steering lock unit harness connector and ground.

(+)		(-)	Voltage (V) (Approx.)
Steering lock unit			
Connector	Terminal		
M40	3	Ground	Battery voltage

Is the inspection result normal?

- YES >> Replace steering lock unit.
 NO >> GO TO 5.

5.CHECK STEERING LOCK UNIT CIRCUIT-2

1. Disconnect IPDM E/R connector.
2. Check continuity between steering lock unit harness connector and IPDM E/R harness connector.

Steering lock unit		IPDM E/R		Continuity
Connector	Terminal	Connector	Terminal	
M40	3	E5	32	Existed

3. Check continuity between steering lock unit harness connector and ground.

Steering lock unit		Ground	Continuity
Connector	Terminal		
M40	3		Not existed

B210A STEERING LOCK UNIT

< DTC/CIRCUIT DIAGNOSIS >

Is the inspection result normal?

- YES >> Replace IPDM E/R. Refer to [PCS-34, "Removal and Installation"](#).
 NO >> Repair or replace harness.

6. CHECK BCM OUTPUT SIGNAL-2

1. Turn ignition switch OFF.
2. Disconnect steering lock unit connector and IPDM E/R connector.
3. Check voltage between steering lock unit harness connector and ground.

(+)		(-)	Voltage (V) (Approx.)
Steering lock unit			
Connector	Terminal		
M40	8	Ground	Battery voltage

Is the inspection result normal?

- YES >> GO TO 8.
 NO >> GO TO 7.

7. CHECK STEERING LOCK UNIT CIRCUIT-3

1. Disconnect BCM connector.
2. Check continuity between steering lock unit harness connector and BCM harness connector.

Steering lock unit		BCM		Continuity
Connector	Terminal	Connector	Terminal	
M40	8	M122	98	Existed

3. Check continuity between steering lock unit harness connector and ground.

Steering lock unit		Ground	Continuity
Connector	Terminal		
M40	8		Not existed

Is the inspection result normal?

- YES >> Replace BCM. Refer to [BCS-81, "Removal and Installation"](#).
 NO >> Repair or replace harness.

8. CHECK IPDM E/R OUTPUT SIGNAL-2

1. Connect IPDM E/R connector.
2. Disconnect BCM connector.
3. Check voltage between steering lock unit harness connector and ground.

(+)		(-)	Voltage (V) (Approx.)
Steering lock unit			
Connector	Terminal		
M40	8	Ground	Battery voltage

Is the inspection result normal?

- YES >> Replace steering lock unit.
 NO >> GO TO 9.

9. CHECK STEERING LOCK UNIT CIRCUIT-4

1. Disconnect IPDM E/R connector.
2. Check continuity between steering lock unit harness connector and IPDM E/R harness connector.

Steering lock unit		IPDM E/R		Continuity
Connector	Terminal	Connector	Terminal	
M40	8	E5	33	Existed

A
B
C
D
E
F
G
H
I
J
L
M
N
O
P

SEC

B210A STEERING LOCK UNIT

< DTC/CIRCUIT DIAGNOSIS >

3. Check continuity between steering lock unit harness connector and ground.

Steering lock unit		Ground	Continuity
Connector	Terminal		
M40	8		Not existed

Is the inspection result normal?

YES >> Replace IPDM E/R. Refer to [PCS-34, "Removal and Installation"](#).

NO >> Repair or replace harness.

B210B STARTER CONTROL RELAY

< DTC/CIRCUIT DIAGNOSIS >

B210B STARTER CONTROL RELAY

Description

INFOID:000000006472005

Starter control relay, integrated in IPDM E/R, permits the starter relay operation when in the N or P position and the steering is locked or unlocked (models with steering lock unit). It is installed parallel to the starter relay.

DTC Logic

INFOID:000000006472006

DTC DETECTION LOGIC

NOTE:

If DTC B210B is displayed with DTC U1000, first perform the trouble diagnosis for DTC U1000. Refer to [PCS-15, "DTC Logic"](#).

DTC No.	Trouble diagnosis name	DTC detecting condition	Possible cause
B210B	START CONT RLY ON	IPDM E/R detects that the relay is stuck in the ON position even if the following conditions are met for about 1 second. <ul style="list-style-type: none">• Starter control relay ON/OFF signal from BCM• Transmission range switch input signal	IPDM E/R

DTC CONFIRMATION PROCEDURE

1. PERFORM DTC CONFIRMATION PROCEDURE

1. Turn the power supply position to start under the following conditions and wait 1 second or more.

A/T models

- Selector lever is in the P or N position
- Do not depress brake pedal

M/T models

- Do not depress clutch pedal
2. Check "Self-diagnosis result" using CONSULT-III.

Is DTC detected?

- YES >> Go to [SEC-105, "Diagnosis Procedure"](#).
NO >> INSPECTION END

Diagnosis Procedure

INFOID:000000006472007

1. INSPECTION START

1. Turn ignition switch ON.
2. Check "Self-diagnosis result" for IPDM E/R using CONSULT-III.
3. Touch "ERASE".
4. **Perform DTC Confirmation Procedure.**
See [SEC-105, "DTC Logic"](#).

Is the DTC B210B displayed again?

- YES >> Replace IPDM E/R. Refer [PCS-34, "Removal and Installation"](#).
NO >> INSPECTION END

B210C STARTER CONTROL RELAY

< DTC/CIRCUIT DIAGNOSIS >

B210C STARTER CONTROL RELAY

Description

INFOID:000000006472008

Starter control relay, integrated in IPDM E/R, permits the starter relay operation when in the N or P position and the steering is locked or unlocked (models with steering lock unit). It is installed parallel to the starter relay.

DTC Logic

INFOID:000000006472009

DTC DETECTION LOGIC

NOTE:

- If DTC B210C is displayed with DTC U1000, first perform the trouble diagnosis for DTC U1000. Refer to [PCS-15, "DTC Logic"](#).
- When IPDM E/R power supply voltage is low (Approx. 7 - 8 V for about 1 second), the DTC B210C may be detected.

DTC No.	Trouble diagnosis name	DTC detecting condition	Possible cause
B210C	START CONT RLY OFF	IPDM E/R detects that the relay is stuck in the OFF position even if the following conditions are met for about 1 second. <ul style="list-style-type: none">• Starter control relay ON/OFF signal from BCM• Transmission range switch input signal	<ul style="list-style-type: none">• IPDM E/R• Battery

DTC CONFIRMATION PROCEDURE

1. PERFORM DTC CONFIRMATION PROCEDURE

1. Turn the power supply position to start under the following conditions and wait 1 second or more.

A/T models

- Selector lever is in the P or N position
- Do not depress brake pedal

M/T models

- Do not depress clutch pedal
2. Check "Self-diagnosis result" using CONSULT-III.

Is DTC detected?

- YES >> Go to [SEC-106, "Diagnosis Procedure"](#).
NO >> INSPECTION END

Diagnosis Procedure

INFOID:000000006472010

1. INSPECTION START

1. Turn ignition switch ON.
2. Check "Self-diagnosis result" for IPDM E/R using CONSULT-III.
3. Touch "ERASE".
4. **Perform DTC Confirmation Procedure.**
See [SEC-106, "DTC Logic"](#).

Is the DTC B210C displayed again?

- YES >> Replace IPDM E/R. Refer to [PCS-34, "Removal and Installation"](#).
NO >> INSPECTION END

B210D STARTER RELAY

< DTC/CIRCUIT DIAGNOSIS >

B210D STARTER RELAY

Description

INFOID:000000006472011

Located in IPDM E/R, the starter relay runs the starter motor. The starter relay is turned ON by the BCM when the ignition switch is in the START position. IPDM E/R transmits the starter relay ON signal to BCM via CAN communication.

DTC Logic

INFOID:000000006472012

DTC DETECTION LOGIC

NOTE:

- If DTC B210D is displayed with DTC U1000, first perform the trouble diagnosis for DTC U1000. Refer to [PCS-15, "DTC Logic"](#).
- If DTC B210D is displayed with DTC B2617, first perform the trouble diagnosis for DTC B2617. Refer to [SEC-92, "DTC Logic"](#).

DTC No.	Trouble diagnosis name	DTC detecting condition	Possible cause
B210D	STARTER RELAY ON	IPDM E/R detects that the relay is stuck in the ON position even if the following conditions are met for about 1 second. <ul style="list-style-type: none">• Starter control relay ON/OFF signal from BCM• Transmission range switch input	IPDM E/R

DTC CONFIRMATION PROCEDURE

1. PERFORM DTC CONFIRMATION PROCEDURE

1. Turn ignition switch ON under the following conditions and wait for 1 second or more.

A/T models

- Selector lever is in the P or N position
- Do not depress brake pedal

M/T models

- Do not depress clutch pedal
2. Check "Self-diagnosis result" using CONSULT-III.

Is DTC detected?

- YES >> Go to [SEC-107, "Diagnosis Procedure"](#).
NO >> INSPECTION END

Diagnosis Procedure

INFOID:000000006472013

1. INSPECTION START

1. Turn ignition switch ON.
2. Check "Self-diagnosis result" for IPDM E/R using CONSULT-III.
3. Touch "ERASE".
4. **Perform DTC Confirmation Procedure.**
See [SEC-107, "DTC Logic"](#).

Is the DTC B210D displayed again?

- YES >> Replace IPDM E/R. Refer to [PCS-34, "Removal and Installation"](#).
NO >> INSPECTION END

B210E STARTER RELAY

< DTC/CIRCUIT DIAGNOSIS >

B210E STARTER RELAY

Description

INFOID:000000006472014

Located in IPDM E/R, the starter relay runs the starter motor. The starter relay is turned ON by the BCM when the ignition switch is in the START position. IPDM E/R transmits the starter relay ON signal to BCM via CAN communication.

DTC Logic

INFOID:000000006472015

DTC DETECTION LOGIC

NOTE:

- If DTC B210E is displayed with DTC U1000, first perform the trouble diagnosis for DTC U1000. Refer to [PCS-15, "DTC Logic"](#).
- If DTC B210E is displayed with DTC B2110 for IPDM E/R, first perform the trouble diagnosis for DTC B2110. Refer to [SEC-112, "DTC Logic"](#).
- When IPDM E/R power supply voltage is low (Approx. 7 - 8 V for about 1 second), the DTC B210F may be detected.

DTC No.	Trouble diagnosis name	DTC detecting condition	Possible cause
B210E	STARTER RELAY OFF	IPDM E/R detects that the relay is stuck in the OFF position even if the following conditions are met for about 1 second. <ul style="list-style-type: none"> • Starter control relay ON/OFF signal from BCM • Transmission range switch input 	<ul style="list-style-type: none"> • Harness or connector (Starter relay circuit is open or short) • IPDM E/R • Battery • BCM

DTC CONFIRMATION PROCEDURE

1. PERFORM DTC CONFIRMATION PROCEDURE

1. Turn ignition switch ON under the following conditions and wait 1 second or more.

A/T models

- Selector lever is in the P or N position
- Do not depress brake pedal

M/T models

- Do not depress clutch pedal
2. Check "Self-diagnosis result" using CONSULT-III.

Is DTC detected?

- YES >> Go to [SEC-108, "Diagnosis Procedure"](#).
 NO >> INSPECTION END

Diagnosis Procedure

INFOID:000000006472016

1. CHECK STARTER RELAY OUTPUT SIGNAL

1. Turn ignition switch OFF.
2. Disconnect BCM connector.
3. Check voltage between BCM harness connector and ground.

(+)		(-)	Condition	Voltage (V) (Approx.)	
BCM					
Connector	Terminal				
M121	52	Ground	Selector lever (A/T models)	P or N position	12
				Other than above	0
			Clutch pedal (M/T models)	Depressed	Battery voltage
				Not depressed	0

Is the inspection result normal?

B210E STARTER RELAY

< DTC/CIRCUIT DIAGNOSIS >

- YES >> GO TO 3.
NO >> GO TO 2.

2.CHECK STARTER RELAY OUTPUT SIGNAL CIRCUIT

1. Disconnect IPDM E/R connector.
2. Check continuity between BCM harness connector and IPDM E/R harness connector.

BCM		IPDM E/R		Continuity
Connector	Terminal	Connector	Terminal	
M121	52	E6	46	Existed

3. Check continuity between BCM harness connector and ground.

BCM		Ground	Continuity
Connector	Terminal		
M121	52		Not existed

Is the inspection result normal?

- YES >> Replace IPDM E/R. Refer to [PCS-34. "Removal and Installation"](#).
NO >> Repair or replace harness.

3.CHECK STARTER RELAY POWER SUPPLY CIRCUIT

1. Turn ignition switch OFF.
2. Disconnect IPDM E/R connector.
3. Check voltage between IPDM E/R harness connector and ground.

(+)		(-)	Voltage (V) (Approx.)
IPDM E/R			
Connector	Terminal		
E5	36	Ground	Battery voltage

Is the inspection result normal?

- YES >> GO TO 4.
NO >> Check harness for open or short between IPDM E/R and battery. Refer to [PCS-26. "Wiring Diagram - IPDM E/R -"](#).

4.REPLACE BCM

1. Replace BCM. Refer to [BCS-3. "ADDITIONAL SERVICE WHEN REPLACING CONTROL UNIT : Special Repair Requirement"](#).
2. Perform DTC CONFIRMATION PROCEDURE. Refer to [SEC-108. "DTC Logic"](#).

Is the inspection result normal?

- YES >> INSPECTION END
NO >> Replace IPDM E/R. Refer to [PCS-34. "Removal and Installation"](#).

B210F SHIFT POSITION/CLUTCH INTERLOCK SWITCH

< DTC/CIRCUIT DIAGNOSIS >

B210F SHIFT POSITION/CLUTCH INTERLOCK SWITCH

Description

INFOID:000000006472017

IPDM E/R confirms the shift position with the following signals.

- Transmission range switch
- Shift position signal from BCM (CAN)

DTC Logic

INFOID:000000006472018

DTC DETECTION LOGIC

NOTE:

If DTC B210F is displayed with DTC U1000, first perform the trouble diagnosis for DTC U1000. Refer to [PCS-15, "DTC Logic"](#)

DTC No.	Trouble diagnosis name	DTC detecting condition	Possible cause
B210F	INTER LOCK/PNP SW ON	IPDM E/R detects the difference between the signals below for 1 second or more. <ul style="list-style-type: none"> • Transmission range switch input signal • Shift position signal from BCM (CAN) 	<ul style="list-style-type: none"> • Harness or connectors [Transmission range switch circuit is open or shorted] • Transmission range switch • IPDM E/R • BCM

DTC CONFIRMATION PROCEDURE

1. PERFORM DTC CONFIRMATION PROCEDURE

1. Turn ignition switch ON under the following conditions and wait 1 second or more.
 - Selector lever is in the P or N position
 - Do not depress brake pedal
2. Check "Self-diagnosis result" using CONSULT-III.

Is DTC detected?

- YES >> Go to [SEC-110, "Diagnosis Procedure"](#).
NO >> INSPECTION END

Diagnosis Procedure

INFOID:000000006472019

1. CHECK DTC WITH BCM

Check "Self-diagnosis result" using CONSULT-III. Refer to [SEC-187, "DTC Index"](#).

Is the inspection result normal?

- YES >> GO TO 2.
NO >> Repair or replace the malfunctioning parts.

2. CHECK TRANSMISSION RANGE SWITCH SIGNAL

1. Turn ignition switch OFF.
2. Disconnect IPDM E/R connector.
3. Turn ignition switch ON.
4. Check voltage between IPDM E/R harness connector and ground.

(+)		(-)	Condition	Voltage (V) (Approx.)	
IPDM E/R					
Connector	Terminal				
E5	30	Ground	Selector lever (A/T models)	N or P position	Battery voltage
				Other than above	0
			Clutch pedal (M/T models)	Depressed	Battery voltage
				Not depressed	0

Is the inspection result normal?

- YES >> Replace IPDM E/R. Refer to [PCS-34, "Removal and Installation"](#).

B210F SHIFT POSITION/CLUTCH INTERLOCK SWITCH

< DTC/CIRCUIT DIAGNOSIS >

NO >> GO TO 3.

3. CHECK TRANSMISSION RANGE SWITCH SIGNAL CIRCUIT

1. Disconnect BCM connector.
2. Check continuity between IPDM E/R harness connector and BCM harness connector.

IPDM E/R		BCM		Continuity
Connector	Terminal	Connector	Terminal	
E5	30	M123	140 (A/T models)	Existed
			114 (M/T models)	

3. Check continuity between IPDM E/R harness connector and ground.

IPDM E/R		Ground	Continuity
Connector	Terminal		
E5	30		Not existed

Is the inspection result normal?

- YES >> Replace BCM. Refer to [BCS-81, "Removal and Installation"](#).
NO >> Repair or replace harness.

A
B
C
D
E
F
G
H
I
J
L
M
N
O
P

SEC

B2110 SHIFT POSITION/CLUTCH INTERLOCK SWITCH

< DTC/CIRCUIT DIAGNOSIS >

B2110 SHIFT POSITION/CLUTCH INTERLOCK SWITCH

Description

INFOID:000000006472020

IPDM E/R confirms the shift position with the following signals.

- Transmission range switch
- Shift position signal from BCM (CAN)

DTC Logic

INFOID:000000006472021

DTC DETECTION LOGIC

NOTE:

If DTC B2110 is displayed with DTC U1000, first perform the trouble diagnosis for DTC U1000. Refer to [PCS-15, "DTC Logic"](#).

DTC No.	Trouble diagnosis name	DTC detecting condition	Possible cause
B2110	INTER LOCK/PNP SW	IPDM E/R detects the difference between the signals below for 1 second or more. <ul style="list-style-type: none">• Transmission range switch input signal• Shift position signal from BCM (CAN)	<ul style="list-style-type: none">• Harness or connectors [Transmission range switch circuit is open or shorted• Transmission range switch• IPDM E/R• BCM

DTC CONFIRMATION PROCEDURE

1. PERFORM DTC CONFIRMATION PROCEDURE

1. Turn the ignition switch ON under the following conditions and wait 1 second or more.

A/T models

- Selector lever is in the P or N position
- Do not depress brake pedal

M/T models

- Do not depress clutch pedal
2. Check "Self-diagnosis result" using CONSULT-III.

Is DTC detected?

- YES >> Go to [SEC-112, "Diagnosis Procedure"](#).
NO >> INSPECTION END

Diagnosis Procedure

INFOID:000000006472022

1. CHECK DTC WITH BCM

Check "Self-diagnosis result" using CONSULT-III. Refer to [SEC-187, "DTC Index"](#).

Is the inspection result normal?

- YES >> GO TO 2.
NO >> Repair or replace the malfunctioning parts.

2. CHECK TRANSMISSION RANGE SWITCH SIGNAL

1. Turn ignition switch OFF.
2. Disconnect IPDM E/R connector.
3. Turn ignition switch ON.
4. Check voltage between IPDM E/R harness connector and ground.

B2110 SHIFT POSITION/CLUTCH INTERLOCK SWITCH

< DTC/CIRCUIT DIAGNOSIS >

(+)		(-)	Condition		Voltage (V) (Approx.)
IPDM E/R					
Connector	Terminal				
E5	30	Ground	Selector lever (A/T models)	N or P position	Battery voltage
				Other than above	0
			Clutch pedal (M/T models)	Depressed	Battery voltage
				Not depressed	0

Is the inspection result normal?

YES >> Replace IPDM E/R. Refer to [PCS-34, "Removal and Installation"](#).

NO >> GO TO 3.

3. CHECK TRANSMISSION RANGE SWITCH SIGNAL CIRCUIT

1. Disconnect BCM connector.
2. Check continuity between IPDM E/R harness connector and BCM harness connector.

IPDM E/R		BCM		Continuity
Connector	Terminal	Connector	Terminal	
E5	30	M123	140 (A/T models)	Existed
			114 (M/T models)	

3. Check continuity between IPDM E/R harness connector and ground.

IPDM E/R		Ground	Continuity
Connector	Terminal		
E5	30		Not existed

Is the inspection result normal?

YES >> Replace BCM. Refer to [BCS-81, "Removal and Installation"](#).

NO >> Repair or replace harness.

A
B
C
D
E
F
G
H
I
J
L
M
N
O
P

SEC

POWER SUPPLY AND GROUND CIRCUIT

< DTC/CIRCUIT DIAGNOSIS >

POWER SUPPLY AND GROUND CIRCUIT

BCM

BCM : Diagnosis Procedure

INFOID:000000006956345

1. CHECK FUSE AND FUSIBLE LINK

Check that the following fuse and fusible link are not blown.

Signal name	Fuse and fusible link No.
Battery power supply	K
	10

Is the fuse fusing?

- YES >> Replace the blown fuse or fusible link after repairing the affected circuit if a fuse or fusible link is blown.
NO >> GO TO 2.

2. CHECK POWER SUPPLY CIRCUIT

1. Turn ignition switch OFF.
2. Disconnect BCM connectors.
3. Check voltage between BCM harness connector and ground.

Terminals		Voltage (Approx.)
(+)	(-)	
BCM		Ground Battery voltage
Connector	Terminal	
M118	1	
M119	11	

Is the measurement value normal?

- YES >> GO TO 3.
NO >> Repair harness or connector.

3. CHECK GROUND CIRCUIT

Check continuity between BCM harness connector and ground.

BCM		Ground	Continuity
Connector	Terminal		
M119	13		Existed

Does continuity exist?

- YES >> INSPECTION END
NO >> Repair harness or connector.

IPDM E/R

IPDM E/R : Diagnosis Procedure

INFOID:000000006956346

1. CHECK FUSES AND FUSIBLE LINK

Check that the following IPDM E/R fuses or fusible links are not blown.

Signal name	Fuses and fusible link No.
Battery power supply	C
	50
	51

POWER SUPPLY AND GROUND CIRCUIT

< DTC/CIRCUIT DIAGNOSIS >

Is the fuse fusing?

YES >> Replace the blown fuse or fusible link after repairing the affected circuit if a fuse or fusible link is blown.

NO >> GO TO 2.

2.CHECK POWER SUPPLY CIRCUIT

1. Turn the ignition switch OFF.
2. Disconnect IPDM E/R connector.
3. Check voltage between IPDM E/R harness connector and the ground.

Terminals		Voltage (Approx.)
(+)	(-)	
IPDM E/R		Battery voltage
Connector	Terminal	
E4	1	

Is the measurement value normal?

YES >> GO TO 3.

NO >> Repair the harness or connector.

3.CHECK GROUND CIRCUIT

Check continuity between IPDM E/R harness connectors and the ground.

IPDM E/R		Ground	Continuity
Connector	Terminal		
E5	12		Existed
E6	41		

Does continuity exist?

YES >> INSPECTION END

NO >> Repair the harness or connector.

A
B
C
D
E
F
G
H
I
J
L
M
N
O
P

SEC

HOOD SWITCH

< DTC/CIRCUIT DIAGNOSIS >

HOOD SWITCH

Description

INFOID:000000006472025

Hood switch is built into hood lock (RH) and connected to IPDM E/R which detects the open/close condition of hood.

Component Function Check

INFOID:000000006472026

1.CHECK FUNCTION

1. Select "HOOD SW" in the "Data Monitor" mode using CONSULT-III.
2. Check the hood switch signal under the following condition.

Test item	Condition		Status
HOOD SW	Hood	Open	ON
		Close	OFF

Is the indication normal?

- YES >> Hood switch is normal.
NO >> Go to [SEC-116, "Diagnosis Procedure"](#).

Diagnosis Procedure

INFOID:000000006472027

1.CHECK HOOD SWITCH SIGNAL

1. Turn ignition switch OFF.
2. Disconnect hood switch connector.
3. Check voltage between hood switch harness connector and ground.

(+)		(-)	Voltage (V) (Approx.)
Hood switch			
Connector	Terminal	Ground	Battery voltage
E30	2		

Is the inspection result normal?

- YES >> GO TO 3.
NO >> GO TO 2.

2.CHECK HOOD SWITCH CIRCUIT

1. Disconnect IPDM E/R connector.
2. Check continuity between IPDM E/R harness connector and hood switch harness connector.

IPDM E/R		Hood switch		Continuity
Connector	Terminal	Connector	Terminal	
E9	104	E30	2	Existed

3. Check continuity between IPDM E/R harness connector and ground.

IPDM E/R		Ground	Continuity
Connector	Terminal		
E9	104		Not existed

Is the inspection result normal?

- YES >> Replace IPDM E/R. Refer to [PCS-34, "Removal and Installation"](#).
NO >> Repair or replace harness.

3.CHECK HOOD SWITCH GROUND CIRCUIT

Check continuity between hood switch harness connector and ground.

HOOD SWITCH

< DTC/CIRCUIT DIAGNOSIS >

Hood switch		Ground	Continuity
Connector	Terminal		
E30	1		Existed

Is the inspection result normal?

- YES >> GO TO 4.
 NO >> Repair or replace harness.

4.CHECK HOOD SWITCH

Refer to [SEC-117. "Component Inspection"](#).

Is the inspection result normal?

- YES >> GO TO 5.
 NO >> Replace hood lock (RH). Refer to [DLK-257. "HOOD LOCK CONTROL : Removal and Installation"](#).

5.CHECK INTERMITTENT INCIDENT

Refer to [GI-43. "Intermittent Incident"](#).

>> INSPECTION END

Component Inspection

INFOID:000000006472028

1.CHECK HOOD SWITCH

- Turn ignition switch OFF.
- Disconnect hood switch connector.
- Check continuity between hood switch terminals.

Hood switch		Condition	Continuity
Terminal			
1	2	Hood	Close the hood
			Open the hood
			Not existed
			Existed

Is the inspection result normal?

- YES >> INSPECTION END
 NO >> Replace hood lock (RH). Refer to [DLK-257. "HOOD LOCK CONTROL : Removal and Installation"](#).

SEC

SECURITY INDICATOR LAMP

< DTC/CIRCUIT DIAGNOSIS >

SECURITY INDICATOR LAMP

Description

INFOID:000000006472029

- Security indicator lamp is located on combination meter.
- IVIS (Nissan Vehicle Immobilizer System) and vehicle security system conditions are indicated by blink or illumination of security indicator lamp.

Component Function Check

INFOID:000000006472030

1. CHECK FUNCTION

1. Perform "THEFT IND" in the "ACTIVE TEST" mode with CONSULT-III.
2. Check security indicator lamp operation.

Test item		Description	
THEFT IND	ON	Security indicator lamp	Illuminates
	OFF		Does not illuminate

Is the inspection result normal?

YES >> INSPECTION END

NO >> Go to [SEC-118, "Diagnosis Procedure"](#).

Diagnosis Procedure

INFOID:000000006472031

1. CHECK SECURITY INDICATOR LAMP POWER SUPPLY CIRCUIT

1. Turn ignition switch OFF.
2. Disconnect combination meter connector.
3. Check voltage between combination meter harness connector and ground.

(+)		(-)	Voltage (V) (Approx.)
Combination meter			
Connector	Terminal	Ground	Battery voltage
M53	1		

Is the inspection result normal?

YES >> GO TO 2.

NO-1 >> 10A fuse [No. 11, located in the fuse block (J/B)].

NO-2 >> Harness for open or short between combination meter and fuse.

2. CHECK SECURITY INDICATOR LAMP SIGNAL

1. Connect combination meter connector.
2. Disconnect BCM connector.
3. Check voltage between BCM harness connector and ground.

(+)		(-)	Voltage (V) (Approx.)
BCM			
Connector	Terminal	Ground	Battery voltage
M123	141		

Is the inspection result normal?

YES >> Replace BCM. Refer to [BCS-81, "Removal and Installation"](#).

NO >> GO TO 3.

3. CHECK COMBINATION METER CIRCUIT

1. Disconnect BCM connector.
2. Check continuity between combination meter harness connector and BCM harness connector.

SECURITY INDICATOR LAMP

< DTC/CIRCUIT DIAGNOSIS >

Combination meter		BCM		Continuity
Connector	Terminal	Connector	Terminal	
M53	10	M123	141	Existed

3. Check continuity between combination meter harness connector and ground.

Combination meter		Ground	Continuity
Connector	Terminal		
M53	10		Not existed

Is the inspection result normal?

- YES >> Replace combination meter. Refer to [MWI-131, "Removal and Installation"](#).
- NO >> Repair or replace harness.

A
B
C
D
E
F
G
H
I
J
L
M
N
O
P

SEC

HORN FUNCTION

< DTC/CIRCUIT DIAGNOSIS >

HORN FUNCTION

Description

INFOID:000000006472032

Perform answer-back for each operation with horn.

Component Function Check

INFOID:000000006472033

1.CHECK FUNCTION

1. Select "VEHICLE SECURITY HORN" in "ACTIVE TEST" mode with CONSULT-III.
2. Check the horn (high/low) operation.

Test item		Description	
VEHICLE SECURITY HORN	ON	Horn	Sounds (for 20 ms)

Is the operation normal?

- YES >> Horn function is OK.
NO >> Refer to [SEC-120. "Diagnosis Procedure"](#).

Diagnosis Procedure

INFOID:000000006472034

1.CHECK HORN SWITCH

Check horn function with horn switch

Do the horns sound?

- YES >> GO TO 2.
NO >> Refer to [HRN-2. "Wiring Diagram - HORN -"](#).

2.CHECK IPDM E/R POWER SUPPLY

1. Disconnect IPDM E/R connector.
2. Check voltage between malfunctioning IPDM E/R harness connector and ground.

(+)		(-)	Voltage (V) (Approx.)
IPDM E/R			
Connector	Terminal	Ground	Battery voltage
E6	Low		
	High	45	

Is the inspection result normal?

- YES >> Replace IPDM E/R. Refer to [PCS-34. "Removal and Installation"](#).
NO >> GO TO 3.

3.CHECK IPDM E/R POWER SUPPLY CIRCUIT

1. Turn ignition switch OFF.
2. Disconnect IPDM E/R connector and horn relay connector.
3. Check continuity between IPDM E/R harness connector and malfunctioning horn relay harness connector.

IPDM E/R		Horn relay		Continuity
Connector	Terminal	Connector	Terminal	
E6	44	E11	1	Existed
	45	E18	3	

4. Check continuity between driver seat control unit harness connector and ground.

HORN FUNCTION

< DTC/CIRCUIT DIAGNOSIS >

IPDM E/R		Ground	Continuity
Connector	Terminal		
E6	44		Not existed
	45		

Is the inspection result normal?

YES >> GO TO 4.

NO >> Repair or replace harness.

4.CHECK INTERMITTENT INCIDENT

Refer to [GI-43. "Intermittent Incident"](#).

Is the inspection result normal?

>> INSPECTION END

A
B
C
D
E
F
G
H
I
J
L
M
N
O
P

SEC

HEADLAMP FUNCTION

< DTC/CIRCUIT DIAGNOSIS >

HEADLAMP FUNCTION

Description

INFOID:000000006472035

Headlamp lighting when vehicle security system is alarm phase.

Component Function Check

INFOID:000000006472036

1.CHECK FUNCTION

1. Perform "HEAD LAMP(HI)" in the "ACTIVE TEST" mode using CONSULT-III.
2. Check headlamp operation.

Test item		Description	
HEAD LAMP (HI)	ON	HEADLAMP (HI)	Lighting
	OFF		Does not lighting

Is the inspection result normal?

- YES >> INSPECTION END
NO >> Refer to [SEC-122, "Diagnosis Procedure"](#).

Diagnosis Procedure

INFOID:000000006472037

1.CHECK HEADLAMP OPERATION

Refer to [SEC-122, "Component Function Check"](#).

Is the inspection result normal?

- YES >> GO TO 2.
NO >> repair or replace the malfunctioning parts.

2.CHECK INTERMITTENT INCIDENT

Refer to [GI-43, "Intermittent Incident"](#).

>> INSPECTION END

INTELLIGENT KEY SYSTEM/ENGINE START FUNCTION

< DTC/CIRCUIT DIAGNOSIS >

INTELLIGENT KEY SYSTEM/ENGINE START FUNCTION

Wiring Diagram - INTELLIGENT KEY SYSTEM/ENGINE START FUNCTION -

INFOID:000000006956347

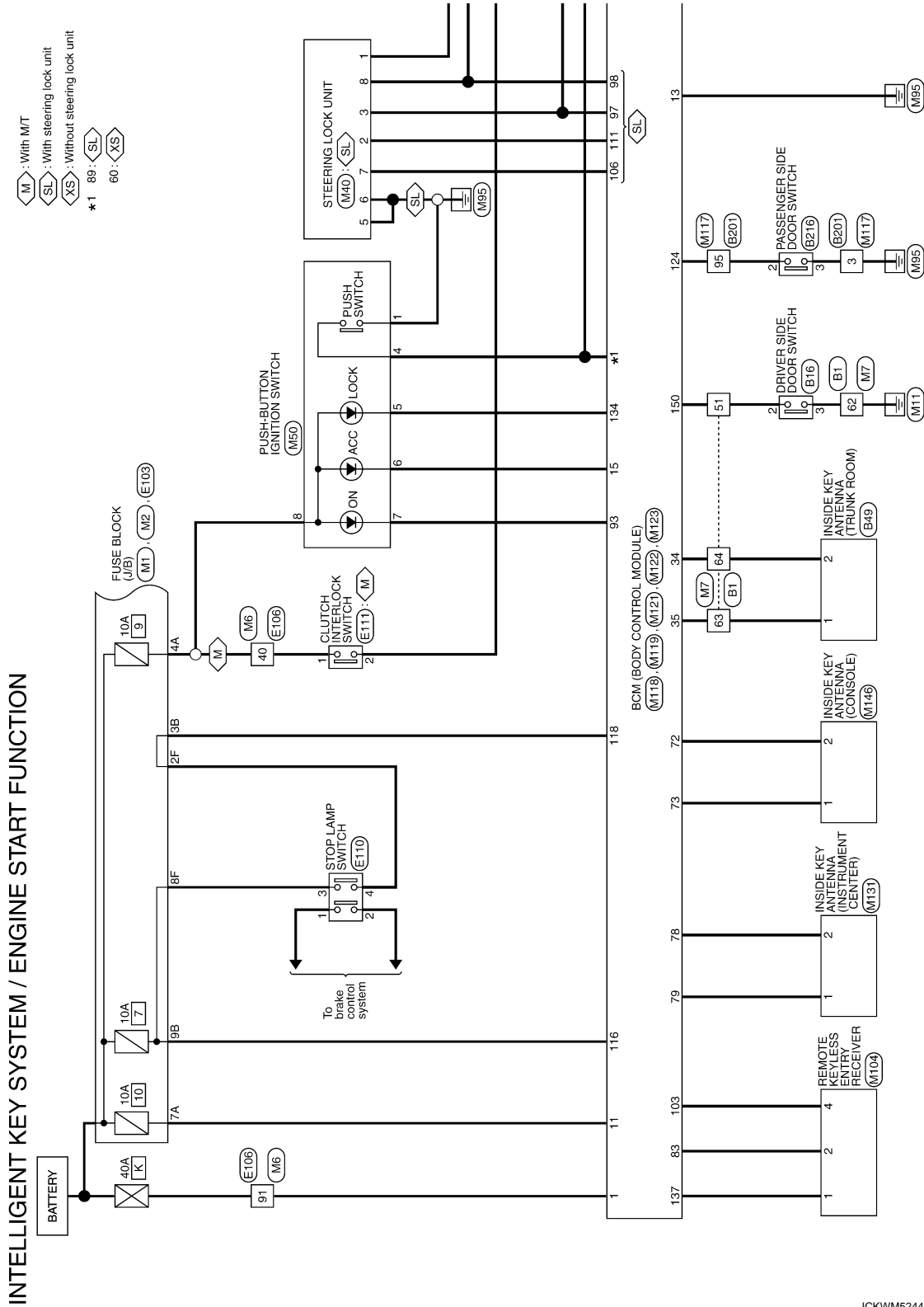

2010/10/12

JCKWM5244GB

A
B
C
D
E
F
G
H
I
J
K
L
M
N
O
P

SEC

INTELLIGENT KEY SYSTEM/ENGINE START FUNCTION

< DTC/CIRCUIT DIAGNOSIS >

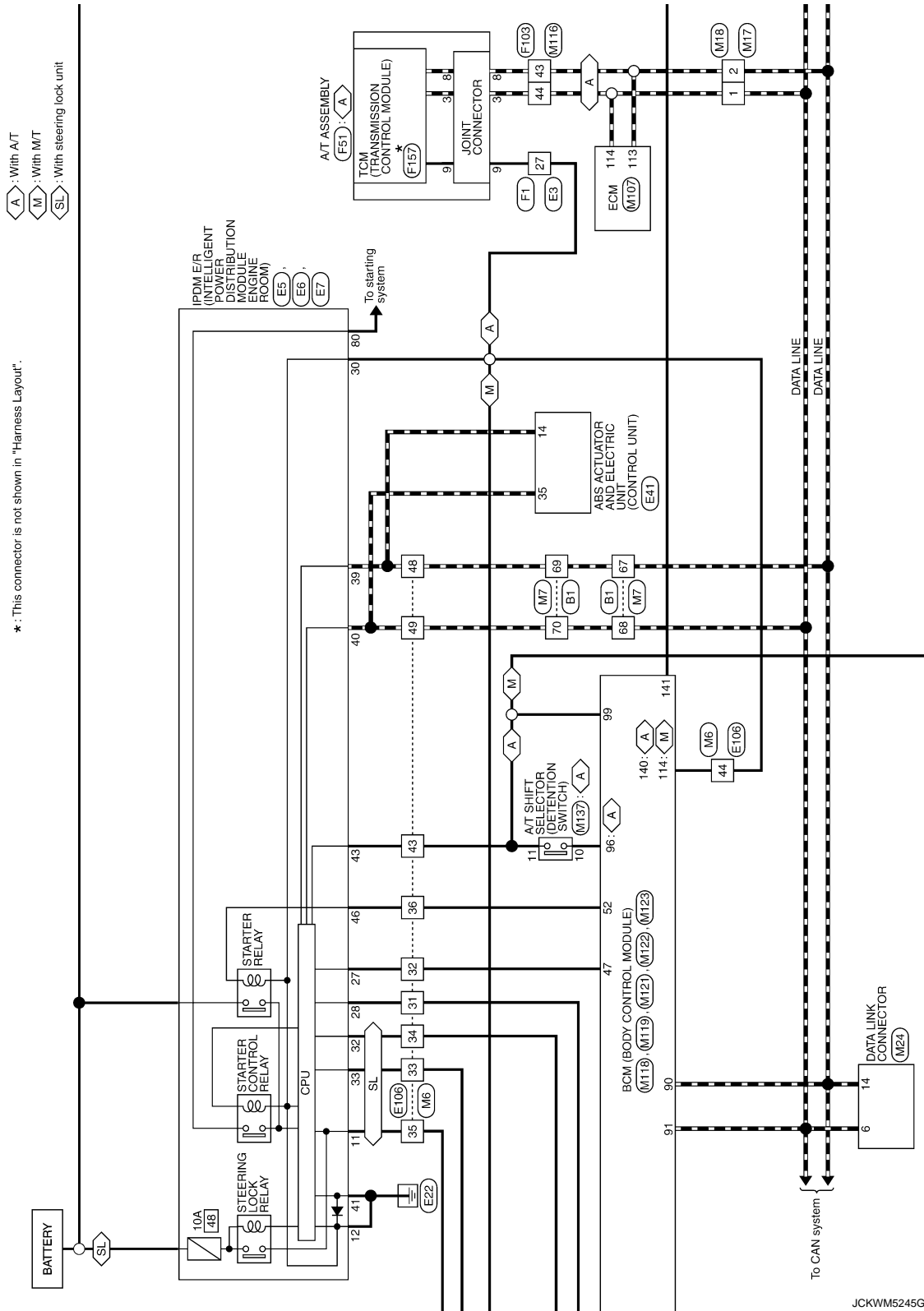

JCKWM5245GB

INTELLIGENT KEY SYSTEM/ENGINE START FUNCTION

< DTC/CIRCUIT DIAGNOSIS >

A : With A/T
M : With M/T

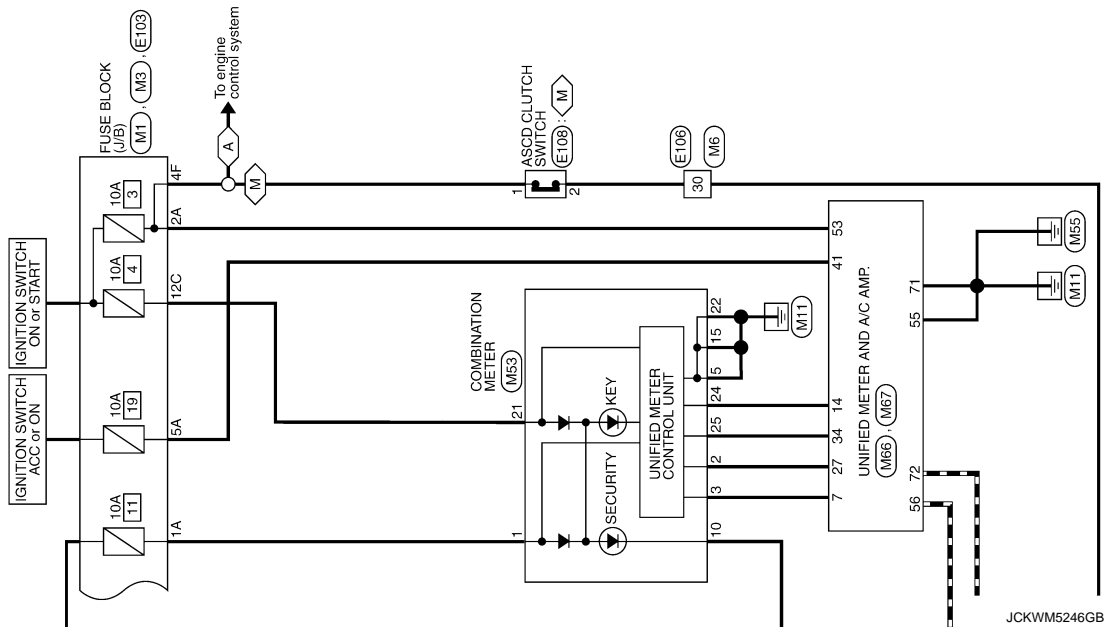

A
B
C
D
E
F
G
H
I
J
L
M
N
O
P

SEC

INTELLIGENT KEY SYSTEM/ENGINE START FUNCTION

< DTC/CIRCUIT DIAGNOSIS >

INTELLIGENT KEY SYSTEM / ENGINE START FUNCTION

Connector No.	B1
Connector Name	WIRE TO WIRE
Connector Type	TH80FW-CS16-TM4



Terminal No.	Color of Wire	Signal Name [Specification]
1	W	
2	L	
3	R	
4	V	
5	W	
6	B	
7	G	
8	BR	
9	LG	
10	BR	
11	SHIELD	
12	Y	
13	Y	
14	L	
15	R	
16	W	
17	BR	
18	Y	
19	Y	
20	G	
21	SB	
22	GR	
23	W	
24	SB	
25	BR	
26	LG	
27	Y	
28	Y	
29	R	
30	Y	
31	SHIELD	
32	G	
33	R	
34	BG	
35	GR	
36	BR	
37	P	
38	Y	
39	Y	
40	SHIELD	
41	L	
42	P	
43	SHIELD	

Connector No.	B16
Connector Name	DRIVER SIDE DOOR SWITCH
Connector Type	A03FW



Terminal No.	Color of Wire	Signal Name [Specification]
2	SB	
3	B	

Connector No.	B49
Connector Name	INSIDE KEY ANTENNA (TRUNK ROOM)
Connector Type	FKG2FGY



Terminal No.	Color of Wire	Signal Name [Specification]
1	L	
2	P	

Connector No.	B201
Connector Name	WIRE TO WIRE
Connector Type	TH80FW-CS16-TM4

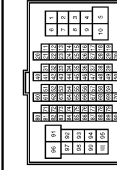

Terminal No.	Color of Wire	Signal Name [Specification]
1	W	
3	B	

Terminal No.	Color of Wire	Signal Name [Specification]
5	W	
6	R	
7	B	
7	B	
7	B	
8	BG	
9	GR	
10	LG	
40	GR	
41	LG	
42	BG	
43	R	
44	SHIELD	
45	G	
47	G	
48	Y	
49	SHIELD	
50	P	
51	SB	
52	LG	
53	L	
54	G	
55	GR	
56	LG	
57	G	
58	R	
67	L	
68	P	
80	G	
81	R	
82	W	
83	B	
84	SHIELD	
85	O	
86	BR	
87	Y	
88	SHIELD	
89	SB	
90	Y	
91	GR	
92	P	
93	L	
94	SB	
95	V	
96	P	
97	L	
97	LG	
98	Y/B	
99	Y	

JCKWM5247GB

INTELLIGENT KEY SYSTEM/ENGINE START FUNCTION

< DTC/CIRCUIT DIAGNOSIS >

INTELLIGENT KEY SYSTEM / ENGINE START FUNCTION

Connector No.	B216
Connector Name	PASSENGER SIDE DOOR SWITCH
Connector Type	AG3FW

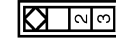

Terminal No.	Color of Wire	Signal Name [Specification]
2	V	
3	B	

Connector No.	E3
Connector Name	WIRE TO WIRE
Connector Type	SAAS0MB-FSS-SHZ3

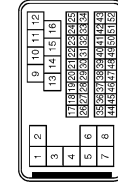

Terminal No.	Color of Wire	Signal Name [Specification]
1	L/Y	
2	SHIELD	
3	L/B	
4	SHIELD	
5	BR	
7	G	
8	W	
9	W	
10	Y	
11	P	
12	SB	
13	BR	
14	G	
15	R	
16	LG	
17	P	
18	Y	
19	BG	
20	B	
21	SB	

22	W	
23	L	
24	G	
25	V	
27	GR	
28	V	
29	P	
30	R	
31	BR	
32	Y	
33	G	
34	BG	
37	SHIELD	
38	L	
39	P	
40	R	
41	W	
42	LG	
43	G	
46	SHIELD	
47	W	
48	BR	
49	G	
50	B	
51	SB	
52	R	

Connector No.	E5
Connector Name	IPWM E/R INTELLIGENT POWER DISTRIBUTION MODULE (ENGINE ROOM)
Connector Type	TH20FW-CS12-M4-1V

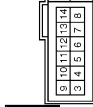

Terminal No.	Color of Wire	Signal Name [Specification]
4	V	
5	L	
6	SB	
7	R	
11	BR	
12	B/W	
13	Y	
16	LG	
19	W	
25	G	

26	R	
27	BG	
28	L	
33	GR	
32	V	
33	P	
36	G	

Connector No.	E6
Connector Name	IPWM E/R INTELLIGENT POWER DISTRIBUTION MODULE (ENGINE ROOM)
Connector Type	TH08FW-NH

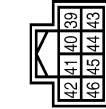

Terminal No.	Color of Wire	Signal Name [Specification]
38	P	
40	L	
41	B/W	
42	Y	
43	SB	
44	LG	
45	G	
46	W	

Connector No.	E7
Connector Name	IPWM E/R INTELLIGENT POWER DISTRIBUTION MODULE (ENGINE ROOM)
Connector Type	TH20FW-CS12-M4

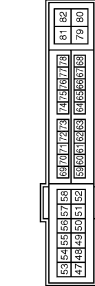

Terminal No.	Color of Wire	Signal Name [Specification]
48	BR	
49	BG	
51	Y	
53	W	
54	P	

55	SB	
56	LG	
57	G	
58	GR	
59	BR	
70	BG	
73	P	
74	G	
75	SB	
76	Y	
77	R	
80	W	

Connector No.	E41
Connector Name	IPSW ACTUATOR AND ELECTRIC UNIT (CONTROL UNIT)
Connector Type	BA442EB-AH24-LH



Terminal No.	Color of Wire	Signal Name [Specification]
1	B	
2	L	
3	R	
4	B	
5	Y	
6	BG	
7	BR	
8	B	
10	W	
11	V	
14	P	
25	Y	
26	LG	
27	GR	
28	G	
29	P	
30	SB	
31	R	
35	L	
45	B	

JCKWM5248GB

A
B
C
D
E
F
G
H
I
J
K
L
M
N
O
P

SEC

INTELLIGENT KEY SYSTEM/ENGINE START FUNCTION

< DTC/CIRCUIT DIAGNOSIS >

INTELLIGENT KEY SYSTEM / ENGINE START FUNCTION

Connector No.	E103
Connector Name	FUSE BLOCK (J/B)
Connector Type	MS16FW-CS



7F	6F	4F	3F	2F	1F
10F	15F	14F	13F	12F	11F
10E	15E	14E	13E	12E	11E
9F	8F	7F	6F	5F	4F

Terminal No.	Color of Wire	Signal Name [Specification]
1F	SB	-
4F	G	-
6F	BG	-
8F	L	-
9F	R	-

Connector No.	E106
Connector Name	WIRE TO WIRE
Connector Type	TH80FW-CS16-TM4



1	2	3	4	5	6	7	8	9	10	11	12	13	14	15	16	17
---	---	---	---	---	---	---	---	---	----	----	----	----	----	----	----	----

Terminal No.	Color of Wire	Signal Name [Specification]
1	GR	-
3	BG	-
4	B/W	-
5	G	-
6	BG	-
7	LG	-
8	G	-
9	R	-
10	W	-
11	V	-
12	R	-
13	L	-
14	GR	-
15	P	-
16	W	-
17	V	-

18	BG	-
19	GR	-
20	LG	-
30	R	-
31	L	-
32	BG	-
33	P	-
34	V	-
35	BR	-
36	W	-
37	Y	-
38	R	-
39	B	-
40	G	-
41	W	-
42	LG	-
43	SB	-
44	GR	-
45	BG	-
46	LG	-
47	V	-
48	P	-
49	L	-
59	B	-
66	LG	-
67	SB	-
68	R	-
69	W	-
70	G	-
80	W	-
81	P	-
82	G	-
83	V	-
84	L	-
85	BG	-
86	LG	-
87	Y	-
88	GR	-
89	W	-
90	W	-
91	G	-
92	B	-
93	GR	-
94	L	-
95	Y	-
97	BR	-
98	SHIELD	-
99	L	-
100	P	-

Connector No.	E108
Connector Name	ASCD CLUTCH SWITCH
Connector Type	S02FL



2	1
---	---

Terminal No.	Color of Wire	Signal Name [Specification]
1	G	-
2	R	-

Connector No.	E110
Connector Name	STOP LAMP SWITCH
Connector Type	M04FP/LC



3	4	1	2
---	---	---	---

Terminal No.	Color of Wire	Signal Name [Specification]
1	L	-
2	V	-
3	Y	- [With ICC] - [Without ICC]
4	SB	- [With ICC] - [Without ICC]
4	W	- [Without ICC]

Connector No.	E111
Connector Name	CLUTCH INTERLOCK SWITCH
Connector Type	S02FL



2	1
---	---

JCKWM5249GB

INTELLIGENT KEY SYSTEM/ENGINE START FUNCTION

< DTC/CIRCUIT DIAGNOSIS >

INTELLIGENT KEY SYSTEM / ENGINE START FUNCTION

Connector No.	F1
Connector Name	WIRE TO WIRE
Connector Type	SA33PF-RSS-S1Z3

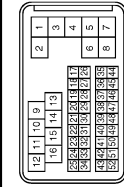

Terminal No.	Color of Wire	Signal Name [Specification]
1	L/Y	-
2	SHIELD	-
3	L/B	-
4	SHIELD	-
5	BR	-
7	G	-
8	W	-
9	W	-
10	G	-
11	R	-
12	P	-
13	L	-
14	LG	-
15	R	-
16	Y	-
17	W	-
18	LG	-
19	P	-
20	O	-
21	BR	-
22	G	-
23	Y	-
24	LG	-
25	V	-
27	GR	-
28	BR	-
29	L	-
30	R	-
31	P	-
32	W	-
33	SB	-
34	O	-
37	SHIELD	-
38	W	-
39	Y	-
40	G	-
41	B	-
42	GR	-

43	R	-
46	SHIELD	-
47	W/L	-
48	LG	-
49	O/L	-
50	L/Y	-
51	W	-
52	L/G	-

Connector No.	F51
Connector Name	A/T ASSEMBLY
Connector Type	RK10FG-DGY

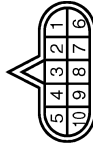

Terminal No.	Color of Wire	Signal Name [Specification]
1	Y	-
2	R	-
3	L	-
4	V	-
5	B	-
6	Y	-
7	R	-
8	P	-
9	GR	-
10	B	-

Connector No.	F103
Connector Name	WIRE TO WIRE
Connector Type	TK33FW-NS10

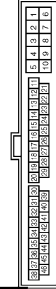

Terminal No.	Color of Wire	Signal Name [Specification]
2	G	-
3	W	-

4	R	-
5	B	-
9	V	-
10	GR	-
19	O	-
20	Y	-
28	B	-
29	LG	-
30	R	-
31	R	-
41	O	-
42	BR	-
43	P	-
44	L	-
45	Y	-
46	V	-

Connector No.	F157
Connector Name	TCM (TRANSMISSION CONTROL MODULE)
Connector Type	SP10FG



Terminal No.	Color of Wire	Signal Name [Specification]
1	-	VIGN
2	-	BATT
3	-	CAN-H
4	-	CAN-L
5	-	GND
6	-	VIGN
7	-	REV LAMP RLY
8	-	CAN-L
9	-	STARTER RLY
10	-	GND

Connector No.	M1
Connector Name	FUSE BLOCK (J/B)
Connector Type	NS30FW-M2

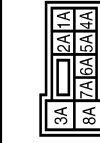

Terminal No.	Color of Wire	Signal Name [Specification]
1A	V	-
2A	G	-
3A	L	-
4A	P	-
5A	BR	-
6A	Y	-
7A	GR	-
8A	L	-

Connector No.	M2
Connector Name	FUSE BLOCK (J/B)
Connector Type	NS10FW-CS



Terminal No.	Color of Wire	Signal Name [Specification]
1B	R	-
3B	P	-
4B	G	-
5B	BG	-
6B	Y	-
7B	P	-
8B	R	-
9B	SB	-

JCKWM5250GB

A
B
C
D
E
F
G
H
I
J
K
L
M
N
O
P

SEC

INTELLIGENT KEY SYSTEM/ENGINE START FUNCTION

< DTC/CIRCUIT DIAGNOSIS >

INTELLIGENT KEY SYSTEM / ENGINE START FUNCTION

Connector No.	M3
Connector Name	FUSE BLOCK (J/B)
Connector Type	MS12FW-CS

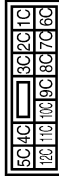

Terminal No.	Color of Wire	Signal Name [Specification]
6C	R	-
7C	B	-
8C	W	-
9C	BG	-
10C	L	-
11C	LG	- [With A/T] - [With M/T]
12C	R	-

Connector No.	M8
Connector Name	WIRE TO WIRE
Connector Type	THR0MW-CS16-TM4

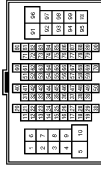

Terminal No.	Color of Wire	Signal Name [Specification]
1	BG	-
3	R	-
4	G	-
5	G	-
6	BR	-
7	BR	-
8	Y	-
9	R	-
10	W	-
11	GR	-
12	R	-
13	L	-
14	G	-
15	P	-
16	W	-

Connector No.	M7
Connector Name	WIRE TO WIRE
Connector Type	THR0MW-CS16-TM4

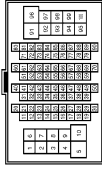

Terminal No.	Color of Wire	Signal Name [Specification]
1	BG	-
2	LG	-
3	G	-
4	V	-
5	L	-
6	B	-
9	L	-
10	BR	-
12	SHIELD	-
13	V	-
14	BR	-
15	GR	-
16	LG	-
17	L	-
20	BR	-
21	G	-
22	R	-
23	SB	-
24	B	-
25	W	-
26	Y	-
27	V	-
28	P	-
29	V	-
31	SHIELD	-
32	G	-
33	R	-
34	BG	-
35	GR	-
36	BR	-
37	P	- [With climate controlled seat]
37	L	- [Without climate controlled seat]
38	V	- [With climate controlled seat]
38	GR	- [Without climate controlled seat]
40	SHIELD	-
41	L	-
42	P	-
43	SHIELD	-

44	Y	-
45	BR	-
46	SB	-
47	SB	-
48	LG	-
49	LG	- [With BOSE system]
49	SB	- [Without BOSE system]
50	SB	- [With BOSE system]
50	LG	- [Without BOSE system]
51	R	-
52	V	-
53	P	-
54	BR	-
55	Y	- [With A/T]
55	BG	- [With M/T]
56	L	-
57	V	-
58	R	-
60	LG	-
61	BG	-
62	B	-
63	V	-
64	SB	-
65	BR	-
66	Y	-
67	P	-
68	L	-
69	P	-
70	L	-
80	G	-
81	LG	-
82	Y	-
83	BR	-
84	V	-
85	L	-
86	Y	-
87	GR	-
81	R	-
83	G	-
94	P	-
95	GR	-
96	Y	-
97	SB	-
99	Y	-
100	Y/B	-

JCKWM5251GB

INTELLIGENT KEY SYSTEM/ENGINE START FUNCTION

< DTC/CIRCUIT DIAGNOSIS >

INTELLIGENT KEY SYSTEM / ENGINE START FUNCTION

Connector No.	M17
Connector Name	WIRE TO WIRE
Connector Type	TK02FW



2	1
---	---

Terminal No.	Color of Wire	Signal Name [Specification]
1	L	-
2	P	-

Connector No.	M18
Connector Name	WIRE TO WIRE
Connector Type	TK02MW



1	2
---	---

Terminal No.	Color of Wire	Signal Name [Specification]
1	L	-
2	P	-

Connector No.	M24
Connector Name	DATA LINK CONNECTOR
Connector Type	BD16FW



9	10	11	12	13	14	15	16
1	2	3	4	5	6	7	8

Terminal No.	Color of Wire	Signal Name [Specification]
3	LG	-
4	B	-

5	BR	-
6	L	-
7	V	-
8	G	-
11	SB	-
14	P	-
16	R	-

Connector No.	M40
Connector Name	STEERING LOCK UNIT
Connector Type	TH08FW-NH



3	2	1
8	7	6
5	4	3

Terminal No.	Color of Wire	Signal Name [Specification]
1	BR	S/L 12V (MECHANICAL)
2	Y	S/L (K LINE)
3	L	S/L CONDITION 1
5	B	GND
6	B	GND
7	W	S/L 12V (CPU)
8	SB	S/L CONDITION 2

Connector No.	M50
Connector Name	PUSH-BUTTON IGNITION SWITCH
Connector Type	TK08FBR



1	2	3
4	5	6
7	8	

Terminal No.	Color of Wire	Signal Name [Specification]
1	B	-
2	W	-
3	Y	-
4	BR	-
5	LG	-
6	EG	-

7	V	-
8	P	-

Connector No.	M53
Connector Name	COMBINATION METER
Connector Type	SAB40FW



1	2	3	4	5	6	7	8	9	10	11	12	13	14	15	16	17	18	19	20
1	2	3	4	5	6	7	8	9	10	11	12	13	14	15	16	17	18	19	20

Terminal No.	Color of Wire	Signal Name [Specification]
1	V	BATTERY POWER SUPPLY
2	LG	COMMUNICATION SIGNAL (METER->AMP)
3	GR	COMMUNICATION SIGNAL (AMP->METER)
5	B	GROUND
6	W	AIR BAG SIGNAL
7	LG	ALTERNATOR SIGNAL
10	R	SECURITY SIGNAL
15	B	GROUND
16	B	METER CONTROL SWITCH GROUND
18	GR	ILL GND
19	B	ILL GND
20	R	ILL
21	R	IGNITION SIGNAL
22	B	GROUND
24	SB	COMMUNICATION SIGNAL (LCD->AMP)
25	B	COMMUNICATION SIGNAL (AMP->LCD)
26	R	VEHICLE SPEED SIGNAL (8-PULSE)
27	V	PARKING BRAKE SWITCH SIGNAL
28	SB	BRAKE FLUID LEVEL SWITCH SIGNAL
29	L	SEAT BELT BUCKLE SW SIGNAL (DRIVER SIDE)
30	G	SEAT BELT BUCKLE SWITCH SIGNAL (PASSENGER SIDE)
31	L	WASHER LEVEL SWITCH SIGNAL
33	R	ILLUMINATION CONTROL SIGNAL
36	LG	SELECT SWITCH SIGNAL
37	SB	ENTER SWITCH SIGNAL
38	L	TRIP A/B RESET SWITCH SIGNAL
39	P	ILLUMINATION CONTROL SWITCH (-)
40	BG	ILLUMINATION CONTROL SWITCH (+)

Connector No.	M66
Connector Name	UNIFIED METER AND A/C AMP.
Connector Type	TH40FW-NH



1	2	3	4	5	6	7	8	9	10	11	12	13	14	15	16	17	18	19	20
1	2	3	4	5	6	7	8	9	10	11	12	13	14	15	16	17	18	19	20

Terminal No.	Color of Wire	Signal Name [Specification]
4	G	STOP LAMP SWITCH
5	L	MANUAL MODE SHIFTER UP SIGNAL
6	BG	PADDLE SHIFTER UP SIGNAL
7	GR	COMMUNICATION SIGNAL (AMP->METER)
8	L	VEHICLE SPEED (2-PULSE)
9	SB	SEAT BELT BUCKLE SWITCH SIGNAL (DRIVER SIDE)
10	W	MANUAL MODE SIGNAL
11	G	NON-MANUAL MODE SIGNAL
14	SB	COMMUNICATION SIGNAL (LCD->AMP)
20	G	IGN ON / OFF SIGNAL
25	V	MANUAL MODE SHIFTER DOWN SIGNAL
26	G	PADDLE SHIFTER DOWN SIGNAL
27	LG	COMMUNICATION SIGNAL (METER->AMP)
28	R	VEHICLE SPEED (8-PULSE)
30	V	PARKING BRAKE SWITCH SIGNAL
34	B	COMMUNICATION SIGNAL (AMP->LCD)
38	P	BLOWER MOTOR CONTROL SIGNAL

A
B
C
D
E
F
G
H
I
J
K
L
M
N
O
P

SEC

JCKWM5252GB

INTELLIGENT KEY SYSTEM/ENGINE START FUNCTION

< DTC/CIRCUIT DIAGNOSIS >

INTELLIGENT KEY SYSTEM / ENGINE START FUNCTION

Connector No.	M67
Connector Name	UNIFIED METER AND A/C AMP.
Connector Type	TH227V-NH



41	42	43	44	45	46	47	53	54	55	56		
57	58	59	60	61	62	63	65	66	69	70	71	72

Terminal No.	Color of Wire	Signal Name [Specification]
41	BR	ACC POWER SUPPLY
42	BR	FUEL LEVEL SENSOR SIGNAL
43	R	INTAKE SENSOR SIGNAL
44	LG	IN-VEHICLE SENSOR SIGNAL
45	V	AMBIENT SENSOR SIGNAL
46	EG	SUNLOAD SENSOR SIGNAL
47	G	EXHAUST GAS OXIDIZER SENSOR SIGNAL
53	W	IGNITION POWER SUPPLY
54	EG	BATTERY POWER SUPPLY
55	B	GROUND
56	L	CAN-H
57	LG	BRAKE FLUID LEVEL SWITCH SIGNAL
58	Y	FUEL LEVEL SENSOR SIGNAL GROUND
59	GR	INTAKE SENSOR GROUND
60	L	IN-VEHICLE SENSOR GROUND
61	R	AMBIENT SENSOR GROUND
62	SB	SUNLOAD SENSOR GROUND
63	L	ION CONTROL MODE OUTPUT SIGNAL
65	EG	ECV SIGNAL
68	L	A/C LAN SIGNAL
70	R	EACH DOOR MOTOR POWER SUPPLY
71	GR	GROUND
72	P	CAN-L

Connector No.	M104
Connector Name	REMOTE KEYLESS ENTRY RECEIVER
Connector Type	JAB04FB



1	2	3	4
---	---	---	---

Terminal No.	Color of Wire	Signal Name [Specification]
1	BG	GROUND
2	Y	SIGNAL OUTPUT
4	LG	BATTERY

Connector No.	M107
Connector Name	ECM
Connector Type	RH24FSY-RZ8-R-LH-Z



128	129	130	131	132	133	134	135	136	137
138	139	140	141	142	143	144	145	146	147

Terminal No.	Color of Wire	Signal Name [Specification]
87	R	APP SEN 1
88	P	APP SEN 2
89	L	SENSOR POWER SUPPLY
100	W	SENSOR GROUND
101	SB	ASC/D/TCB STEERING SW
102	G	EVAP CONTROL SYSTEM PRESS SEN
103	G	SENSOR POWER SUPPLY
104	GR	SENSOR GROUND
105	L	REFRIGERANT PRESS SEN
106	LG	FUEL TANK TEMP SEN
107	BR	SENSOR POWER SUPPLY
108	Y	SENSOR GROUND
109	G	PNP SIGNAL
110	BR	ENGINE SPEED OUTPUT SIGNAL
112	P	SENSOR GROUND
113	P	CAN COMMUNICATION LINE
114	L	CAN COMMUNICATION LINE
117	V	DATA LINK CONNECTOR
121	LG	EVAP CANISTER VENT CONTROL VALVE
122	P	STOP LAMP SW
123	B	ECM GROUND
124	B	ECM GROUND
125	R	POWER SUPPLY FOR ECM
126	BR	ASC/D/TCB BRAKE SW
127	B	ECM GROUND
128	B	ECM GROUND

Connector No.	M116
Connector Name	WIRE TO WIRE
Connector Type	TK38MW-AS10



1	2	3	4	5	6	7	8	9	10	11	12	13	14	15	16	17	18	19	20	21	22	23	24	25	26	27	28	29	30	31	32	33	34	35	36	37	38	39	40	41	42	43	44	45	46	47	48	49	50	51	52	53	54	55	56	57	58	59	60	61	62	63	64	65	66	67	68	69	70	71	72	73	74	75	76	77	78	79	80	81	82	83	84	85	86	87	88	89	90	91	92	93	94	95	96	97	98	99
---	---	---	---	---	---	---	---	---	----	----	----	----	----	----	----	----	----	----	----	----	----	----	----	----	----	----	----	----	----	----	----	----	----	----	----	----	----	----	----	----	----	----	----	----	----	----	----	----	----	----	----	----	----	----	----	----	----	----	----	----	----	----	----	----	----	----	----	----	----	----	----	----	----	----	----	----	----	----	----	----	----	----	----	----	----	----	----	----	----	----	----	----	----	----	----	----	----	----

Terminal No.	Color of Wire	Signal Name [Specification]
2	W	
3	BG	
4	R	
5	B	
9	R	
10	R	
18	EG	
20	Y	
28	GR	
29	LG	
30	LG	
31	W	
41	BG	
42	G	
43	P	
44	L	
45	G	
46	Y	

Connector No.	M117
Connector Name	WIRE TO WIRE
Connector Type	TH68MW-CS16-TM4



1	2	3	4	5	6	7	8	9	10	11	12	13	14	15	16	17	18	19	20	21	22	23	24	25	26	27	28	29	30	31	32	33	34	35	36	37	38	39	40	41	42	43	44	45	46	47	48	49	50	51	52	53	54	55	56	57	58	59	60	61	62	63	64	65	66	67	68	69	70	71	72	73	74	75	76	77	78	79	80	81	82	83	84	85	86	87	88	89	90	91	92	93	94	95	96	97	98	99
---	---	---	---	---	---	---	---	---	----	----	----	----	----	----	----	----	----	----	----	----	----	----	----	----	----	----	----	----	----	----	----	----	----	----	----	----	----	----	----	----	----	----	----	----	----	----	----	----	----	----	----	----	----	----	----	----	----	----	----	----	----	----	----	----	----	----	----	----	----	----	----	----	----	----	----	----	----	----	----	----	----	----	----	----	----	----	----	----	----	----	----	----	----	----	----	----	----	----

Terminal No.	Color of Wire	Signal Name [Specification]
1	Y	
3	B	
5	SB	
6	R	

Terminal No.	Color of Wire	Signal Name [Specification]
7	G	
8	SB	
9	GR	
10	LG	
40	Y	
41	G	
42	LG	
43	R	
44	SHIELD	
45	G	
47	P	
48	L	
49	SHIELD	
50	V	
51	SB	
52	BG	
53	L	
54	G	
55	Y	
56	LG	
57	SB	
58	LG	
67	SB	
68	LG	
80	W	
81	B	
82	R	
83	G	
84	SHIELD	
85	G	
86	L	
87	P	
88	SHIELD	
89	Y	
90	W	
91	GR	
92	P	
93	W	
94	BG	
95	BG	
96	P	
97	L	
98	Y/B	
99	Y	

INTELLIGENT KEY SYSTEM/ENGINE START FUNCTION

< DTC/CIRCUIT DIAGNOSIS >

INTELLIGENT KEY SYSTEM / ENGINE START FUNCTION

Connector No.	M118
Connector Name	BCM (BODY CONTROL MODULE)
Connector Type	M02FB-LC



Terminal No.	Color of Wire	Signal Name [Specification]
1	W	BAT (F/L)
2	Y	POWER WINDOW POWER SUPPLY (BAT)
3	BG	POWER WINDOW POWER SUPPLY (RAP)

Connector No.	M119
Connector Name	BCM (BODY CONTROL MODULE)
Connector Type	NS16FW-CS



Terminal No.	Color of Wire	Signal Name [Specification]
4	LG	INTERIOR ROOM LAMP POWER SUPPLY
5	P	PASSENGER DOOR UNLOCK OUTPUT
7	SB	STEER LAMP
8	V	ALL DOOR FUEL LID LOCK OUTPUT
9	G	DRIVER DOOR FUEL LID UNLOCK OUTPUT
11	GR	BAT (FUSE)
13	B	GND
14	W	PUSH-BUTTON IGNITION SW ILL GND
15	BG	ACC IND
17	BR	TURN SIGNAL RH (FRONT)
18	BG	TURN SIGNAL LH (FRONT)
19	V	ROOM LAMP TIMER CONTROL

Connector No.	M121
Connector Name	BCM (BODY CONTROL MODULE)
Connector Type	TH40FGY-NH



Terminal No.	Color of Wire	Signal Name [Specification]
34	SB	TRUNK ROOM ANT-
35	V	TRUNK ROOM ANT+
38	B	REAR BUMPER ANT-
39	W	REAR BUMPER ANT+
47	Y	IGN RELAY (P/D) L (R) CONT
50	G	TRUNK ROOM LAMP SW
52	BR	STARTER RELAY CONT
60	BR	PUSH SW
61	SB	TRUNK LID OPENER REQUEST SW
64	G	F-KEY WARM BUZZER (ENG ROOM)
67	GR	TRUNK LID OPENER SW

Connector No.	M122
Connector Name	BCM (BODY CONTROL MODULE)
Connector Type	TH40FB-NH



Terminal No.	Color of Wire	Signal Name [Specification]
72	R	ROOM ANT 2-
73	G	ROOM ANT 2+
74	SB	PASSENGER DOOR ANT-
75	BR	PASSENGER DOOR ANT+
76	V	DRIVER DOOR ANT-
77	LG	DRIVER DOOR ANT+
78	Y	ROOM ANT 1-
79	BR	ROOM ANT 1+
80	GR	NAIS ANTENNA AMP
81	W	NAIS ANTENNA AMP
82	R	IGN RELAY (F/B) CONT

83	Y	KEYLESS ENTRY RECEIVER COMM
87	Y	COMBI SW INPUT 5
88	BG	COMBI SW INPUT 3
89	BR	PUSH SW
90	P	CAN-L
91	L	CAN-H
92	LG	KEY SLOT ILL
93	V	ON IND
95	BG	ACC RELAY CONT
96	GR	A/T SHIFT SELECTOR POWER SUPPLY
97	L	S/L CONDITION 1
98	SB	S/L CONDITION 2
99	R	ASCOD CLUTCH SW [With M/T]
100	Y	PASSENGER DOOR REQUEST SW
101	P	DRIVER DOOR REQUEST SW
102	BG	BLOWER FAN MOTOR RELAY CONT
103	LG	KEYLESS ENTRY RECEIVER POWER SUPPLY
106	W	S/L UNIT POWER SUPPLY
107	LG	COMBI SW INPUT 1
108	R	COMBI SW INPUT 4
109	W	COMBI SW INPUT 2
110	G	HAZARD SW
111	Y	S/L UNIT COMM

Connector No.	M123
Connector Name	BCM (BODY CONTROL MODULE)
Connector Type	TH40FG-NH



Terminal No.	Color of Wire	Signal Name [Specification]
112	BR	RAIN SENSOR SERIAL LINK
113	G	OPTICAL SENSOR
114	R	CLUTCH INTERLOCK SW
116	SB	STOP LAMP SW 1
118	BR	STOP LAMP SW 2
119	GR	DR DOOR UNLOCK SENSOR
121	SB	KEY SLOT SW
123	W	IGN F/B
124	BG	PASSENGER DOOR SW
129	BG	TRUNK LID OPENER CANCEL SW
132	LG	P/W SW & PHT C/U COMM
133	Y	PUSH-BUTTON IGNITION SW ILL POWER

134	LG	LOCK IND
137	BG	RECEIVER / SENSOR GND
138	Y	RECEIVER / SENSOR POWER SUPPLY
139	L	TIRE PRESSURE RECEIVER COMM
140	GR	SHIFT N/P
141	R	SECURITY INDICATOR LAMP
142	BR	COMBI SW OUTPUT 5
143	V	COMBI SW OUTPUT 1
144	G	COMBI SW OUTPUT 2
145	L	COMBI SW OUTPUT 3
146	SB	COMBI SW OUTPUT 4
150	R	DRIVER DOOR SW
151	G	REAR WINDOW DEFOGGER RELAY CONT

Connector No.	M131
Connector Name	INSIDE KEY ANTENNA (INSTRUMENT CENTER)
Connector Type	RK02FGY



Terminal No.	Color of Wire	Signal Name [Specification]
1	BR	-
2	Y	-

JCKWM5254GB

A
B
C
D
E
F
G
H
I
J
K
L
M
N
O
P

SEC

INTELLIGENT KEY SYSTEM/ENGINE START FUNCTION

< DTC/CIRCUIT DIAGNOSIS >

INTELLIGENT KEY SYSTEM / ENGINE START FUNCTION

Connector No.	M137
Connector Name	A/T SHIFT SELECTOR
Connector Type	TH12FV-NH

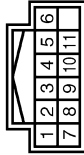

Terminal No.	Color of Wire	Signal Name [Specification]
1	W	-
2	V	-
3	L	-
4	BR	-
5	G	-
7	Y	-
8	SB	-
9	B	-
10	GR	-
11	R	-

Connector No.	M146
Connector Name	INSIDE KEY ANTENNA (CONSOLE)
Connector Type	RK02FGY



Terminal No.	Color of Wire	Signal Name [Specification]
1	G	-
2	R	-

JCKWM5255GB

INFINITI VEHICLE IMMOBILIZER SYSTEM-NATS

< DTC/CIRCUIT DIAGNOSIS >

INFINITI VEHICLE IMMOBILIZER SYSTEM-NATS

Wiring Diagram - INFINITI VEHICLE IMMOBILIZER SYSTEM -

INFOID:000000006956348

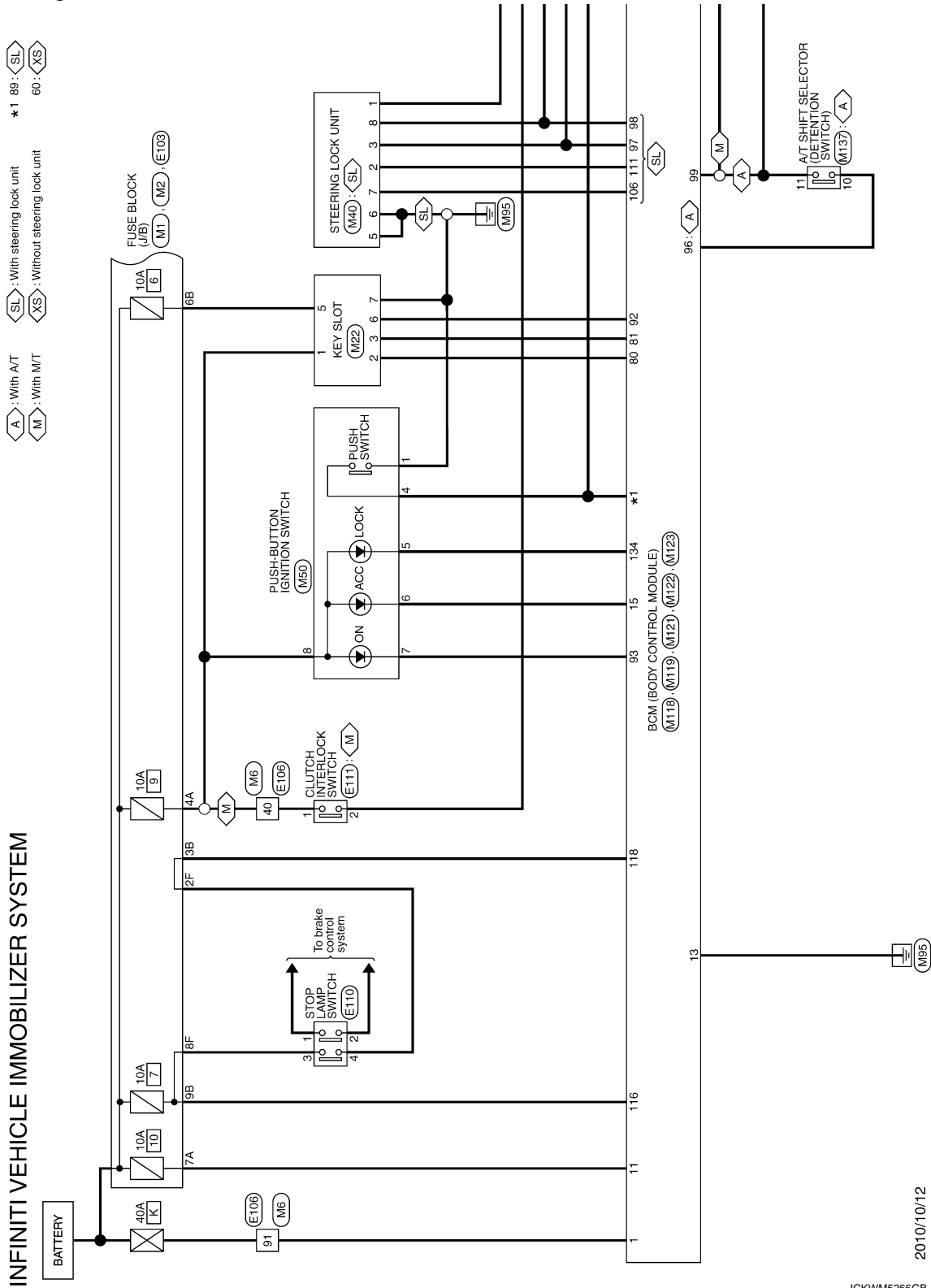

2010/10/12

JCKWM5266GB

A
B
C
D
E
F
G
H
I
J
K
L
M
N
O
P

SEC

INFINITI VEHICLE IMMOBILIZER SYSTEM-NATS

< DTC/CIRCUIT DIAGNOSIS >

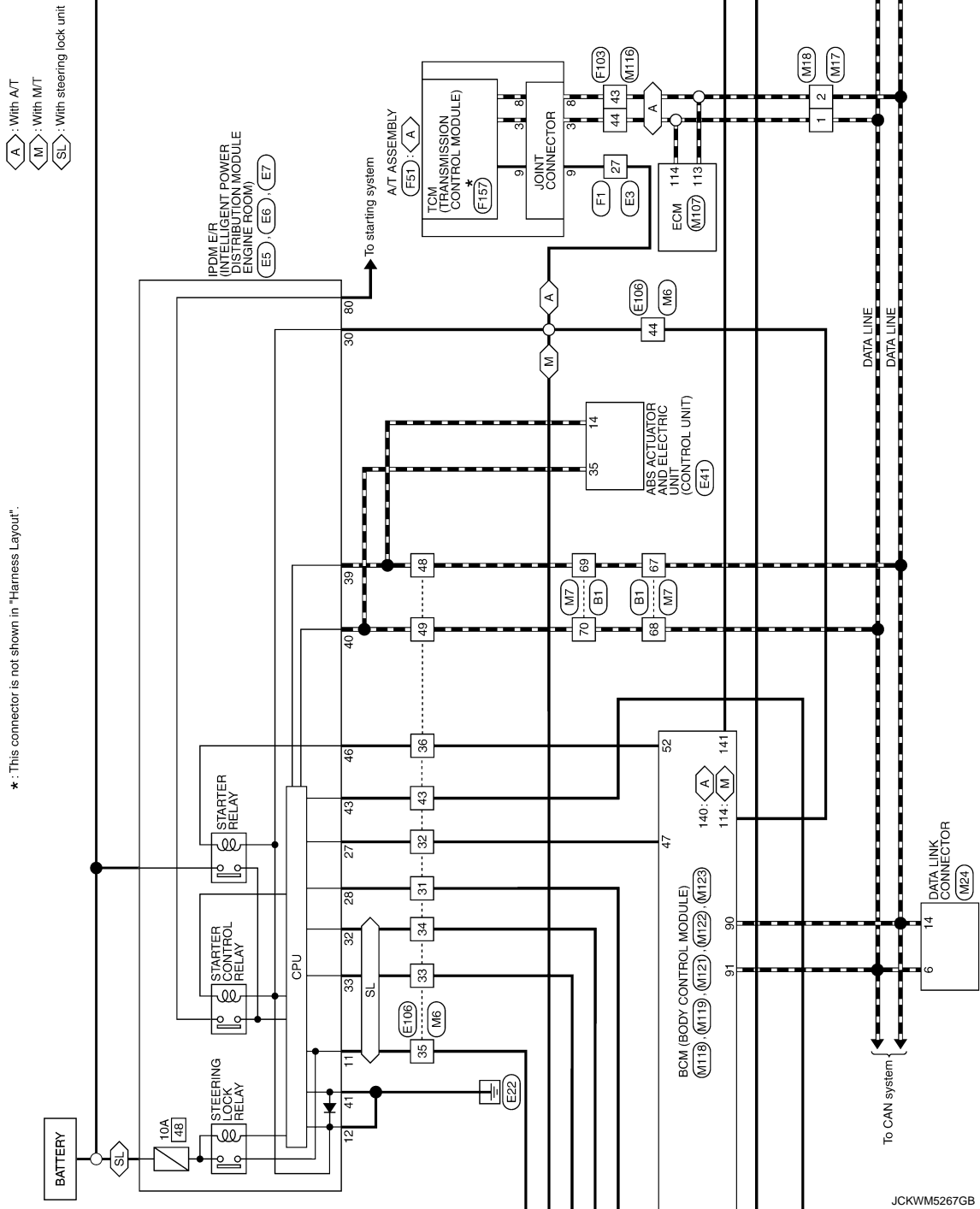

JCKWM5267GB

INFINITI VEHICLE IMMOBILIZER SYSTEM-NATS

< DTC/CIRCUIT DIAGNOSIS >

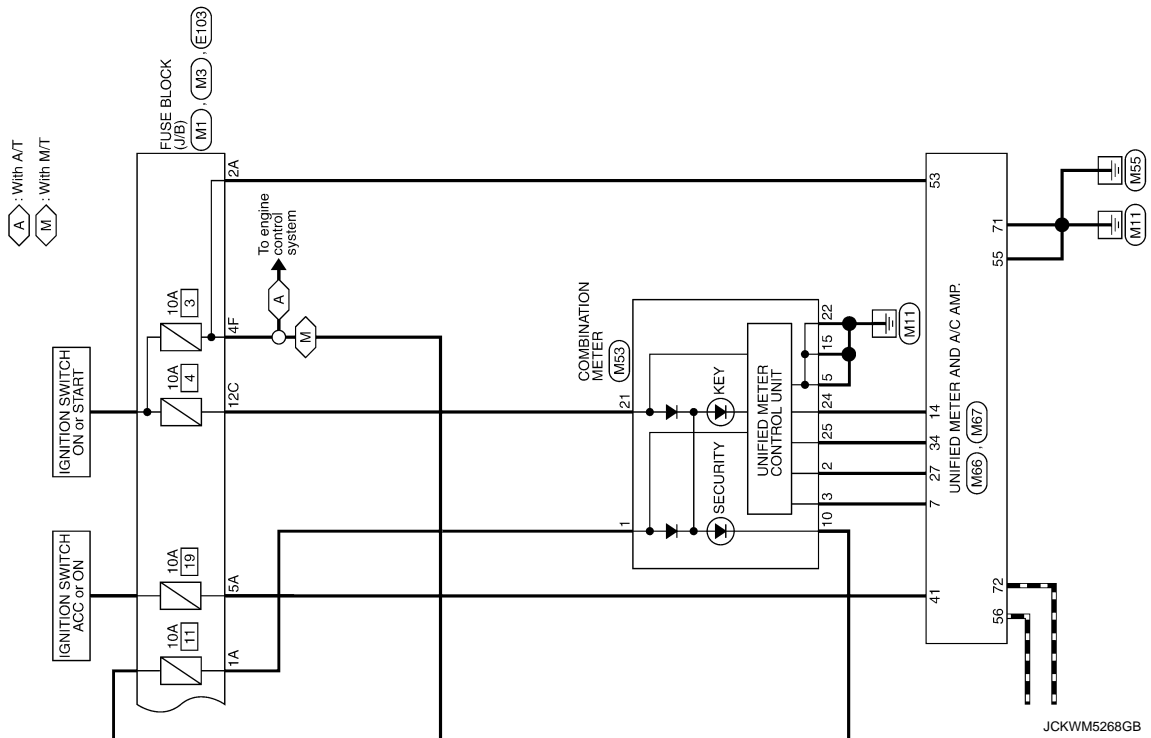

A
B
C
D
E
F
G
H
I
J
L
M
N
O
P

SEC

INFINITI VEHICLE IMMOBILIZER SYSTEM-NATS

< DTC/CIRCUIT DIAGNOSIS >

INFINITI VEHICLE IMMOBILIZER SYSTEM

Connector No.	B1
Connector Name	WIRE TO WIRE
Connector Type	TH2DFW-CS16-TM4



Terminal No.	Color of Wire	Signal Name [Specification]
44	SB	
45	V	
46	W	
47	SB	
48	LG	
49	LG	- [With BOSE system]
49	Y	- [Without BOSE system]
50	SB	- [With BOSE system]
50	LG	- [Without BOSE system]
51	SB	
52	G	
53	LG	
54	BR	
55	Y	
56	W	
57	V	
58	R	
60	R	
61	BG	
62	B	
63	L	
64	P	
65	B	
66	SB	
67	P	
68	L	
69	P	
70	L	
80	G	
81	V	
82	R	
83	BR	
84	G	
85	L	
86	Y	
87	GR	
91	R	
93	BG	
94	P	
95	GR	
96	GR	
97	SB	
99	Y	
100	Y/B	

Connector No.	E3
Connector Name	WIRE TO WIRE
Connector Type	SAA38MF-RS8-S1Z3

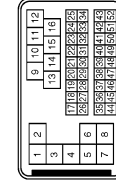

43	G	
46	SHIELD	
47	W	
48	BR	
49	G	
50	B	
51	SB	
52	R	

Connector No.	E5
Connector Name	IPDM E/R INTELLIGENT POWER DISTRIBUTION MODULE (ENGINE ROOM)
Connector Type	TH2DFW-CS12-M4-1V

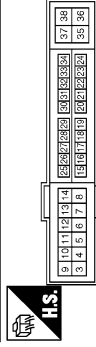

Terminal No.	Color of Wire	Signal Name [Specification]
1	L/Y	
2	SHIELD	
3	L/B	
4	SHIELD	
5	BR	
7	G	
8	W	
9	W	
10	Y	
11	P	
12	SB	
13	BR	
14	G	
15	R	
16	LG	
17	P	
18	Y	
19	BG	
20	B	
21	SB	
22	W	
23	L	
24	G	
25	V	
26	GR	
27	P	
28	V	
29	V	
30	R	
31	BR	
32	Y	
33	G	
34	BG	
37	SHIELD	
38	L	
39	P	
40	R	
41	W	
42	LG	

Terminal No.	Color of Wire	Signal Name [Specification]
4	V	
5	L	
6	SS	
7	R	
11	BR	
12	B/W	
13	Y	
16	LG	
19	W	
25	G	
26	R	
27	BG	
28	V	
30	GR	
32	V	
33	P	
36	G	

JCKWM5269GB

INFINITI VEHICLE IMMOBILIZER SYSTEM-NATS

< DTC/CIRCUIT DIAGNOSIS >

INFINITI VEHICLE IMMOBILIZER SYSTEM

Connector No.	E6
Connector Name	IGN-IP INTELLIGENT POWER DISTRIBUTION MODULE ENGINE ROOM
Connector Type	TH20FW-NH

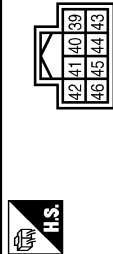

Terminal No.	Color of Wire	Signal Name [Specification]
39	P	-
40	L	-
41	B/W	-
42	Y	-
43	SB	-
44	LG	-
45	G	-
46	W	-

Connector No.	E7
Connector Name	IGN-IP INTELLIGENT POWER DISTRIBUTION MODULE ENGINE ROOM
Connector Type	TH20FW-CS12-M4

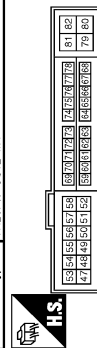

Terminal No.	Color of Wire	Signal Name [Specification]
48	BR	-
49	BG	-
51	Y	-
53	W	-
54	P	-
55	SB	-
56	LG	-
57	G	-
58	GR	-
60	BR	-
70	BG	-
73	P	-
74	G	-
75	SB	-

Connector No.	E11
Connector Name	ABS ACTUATOR AND ELECTRIC UNIT (CONTROL UNIT)
Connector Type	BAA12FB-AH24-LH



Terminal No.	Color of Wire	Signal Name [Specification]
1	B	GND
2	L	UEMR
3	R	UEVR
4	B	GND
5	Y	DS FL
6	BG	DP RL
7	BR	DP RR
9	B	DP FR
10	W	DS FR
11	V	DIAG-K
14	P	CAN-L
25	Y	BUS-L
26	LG	DP FL
27	GR	DS RL
28	G	LIZ
29	P	DS RR
30	SB	BLS
31	R	VDC DTC SWITCH
35	L	CAN-H
45	B	BUS-H

Connector No.	E103
Connector Name	FUSE BLOCK (U/B)
Connector Type	MS16FW-CS

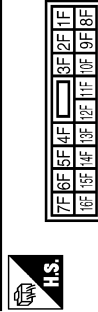

Terminal No.	Color of Wire	Signal Name [Specification]
1F	SB	-
2F	V	-
4F	G	-
6F	BG	-
9F	L	-
9F	R	-

Connector No.	E106
Connector Name	WIRE TO WIRE
Connector Type	TH80FW-CS16-TM4

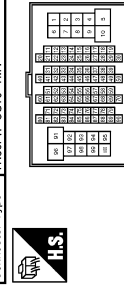

Terminal No.	Color of Wire	Signal Name [Specification]
1	GR	-
3	BG	-
4	B/W	-
5	G	-
6	BG	-
7	LG	-
8	G	-
9	R	-
10	W	-
11	V	-
12	R	-
13	L	-
14	GR	-
15	P	-
16	W	-
17	V	-

18	BG	-
19	GR	-
20	LG	-
30	R	-
31	L	-
32	BG	-
33	P	-
34	V	-
35	BR	-
36	W	-
37	Y	-
38	R	-
39	B	-
40	G	-
41	W	-
42	LG	-
43	SB	-
44	GR	-
45	BG	-
46	LG	-
47	V	-
48	P	-
49	L	-
59	B	-
66	LG	-
67	SB	-
68	R	-
69	W	-
70	G	-
80	W	-
81	P	-
82	G	-
83	V	-
84	L	-
85	BG	-
86	LG	-
87	L	-
88	GR	-
89	W	-
90	W	-
91	G	-
92	B	-
93	GR	-
94	L	-
95	Y	-
97	BR	-
98	SHIELD	-
99	L	-
100	P	-

A
B
C
D
E
F
G
H
I
J
K
L
M
N
O
P

SEC

JCKWM5270GB

INFINITI VEHICLE IMMOBILIZER SYSTEM-NATS

< DTC/CIRCUIT DIAGNOSIS >

INFINITI VEHICLE IMMOBILIZER SYSTEM

Connector No.	E108
Connector Name	ASCD CLUTCH SWITCH
Connector Type	S09FL



Terminal No.	Color of Wire	Signal Name [Specification]
1	G	-
2	R	-

Connector No.	E110
Connector Name	STOP LAMP SWITCH
Connector Type	MD4FW-LC



Terminal No.	Color of Wire	Signal Name [Specification]
1	L	-
2	V	-
3	L	- [With ICC]
3	Y	- [Without ICC]
4	SB	- [With ICC]
4	W	- [Without ICC]

Connector No.	E111
Connector Name	CLUTCH INTERLOCK SWITCH
Connector Type	S09FL



Terminal No.	Color of Wire	Signal Name [Specification]
1	G	-
2	GR	-

Connector No.	F1
Connector Name	WIRE TO WIRE
Connector Type	SAA36FB-RS3-SHZ3

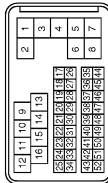

Terminal No.	Color of Wire	Signal Name [Specification]
1	L/Y	-
2	SHIELD	-
3	L/B	-
4	SHIELD	-
5	BR	-
7	G	-
8	W	-
9	W	-
10	G	-
11	R	-
12	P	-
13	L	-
14	LG	-
15	R	-
16	Y	-
17	W	-
18	LG	-
19	P	-
20	O	-
21	BR	-
22	G	-
23	Y	-
24	LG	-
25	V	-
27	GR	-
28	BR	-
29	L	-
30	R	-
31	P	-
32	W	-
33	SB	-
34	O	-

37	SHIELD	-
38	W	-
39	Y	-
40	G	-
41	B	-
42	GR	-
43	R	-
48	SHIELD	-
47	W/L	-
48	LG	-
49	O/L	-
50	L/Y	-
51	W	-
52	L/G	-

Connector No.	F51
Connector Name	A/T ASSEMBLY
Connector Type	RK10FG-DCY

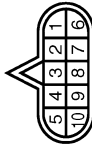

Terminal No.	Color of Wire	Signal Name [Specification]
1	Y	-
2	R	-
3	L	-
4	V	-
5	B	-
6	Y	-
7	R	-
8	P	-
9	GR	-
10	B	-

Connector No.	F103
Connector Name	WIRE TO WIRE
Connector Type	TK36FW-NS10

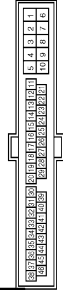

Terminal No.	Color of Wire	Signal Name [Specification]
2	G	-
3	W	-
4	R	-
5	B	-
9	Y	-
10	GR	-
19	O	-
20	Y	-
28	B	-
29	LG	-
30	R	-
31	R	-
41	O	-
42	BR	-
43	P	-
44	L	-
45	Y	-
46	V	-

INFINITI VEHICLE IMMOBILIZER SYSTEM-NATS

< DTC/CIRCUIT DIAGNOSIS >

INFINITI VEHICLE IMMOBILIZER SYSTEM

Connector No.	F157
Connector Name	TCM (TRANSMISSION CONTROL MODULE)
Connector Type	SP10FG

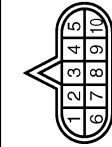

Terminal No.	Color of Wire	Signal Name [Specification]
1	-	VIGN
2	-	BATT
3	-	CAN-H
4	-	K-LINE
5	-	GND
6	-	VIGN
7	-	REV LAMP RLY
8	-	CAN-L
9	-	STARTER RLY
10	-	GND

Connector No.	M1
Connector Name	FUSE BLOCK (J/B)
Connector Type	NS08FW-M2

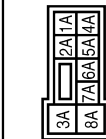

Terminal No.	Color of Wire	Signal Name [Specification]
1A	V	-
2A	G	-
3A	L	-
4A	P	-
5A	BR	-
6A	Y	-
7A	GR	-
8A	L	-

Connector No.	M2
Connector Name	FUSE BLOCK (J/B)
Connector Type	NS12FW-CS

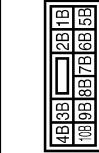

Terminal No.	Color of Wire	Signal Name [Specification]
1B	R	-
2B	P	-
3B	G	-
4B	GR	-
5B	BG	-
6B	Y	-
7B	P	-
8B	R	-
9B	SB	-

Connector No.	M3
Connector Name	FUSE BLOCK (J/B)
Connector Type	NS12FW-CS

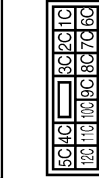

Terminal No.	Color of Wire	Signal Name [Specification]
6C	R	-
7C	B	-
8C	W	-
9C	BG	-
10C	L	-
11C	LG	-
12C	R	-

Connector No.	M5
Connector Name	WIRE TO WIRE
Connector Type	TH62MW-CS1.6-TM4

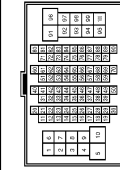

Terminal No.	Color of Wire	Signal Name [Specification]
1	BG	-
2	R	-
3	R	-
4	G	-
5	G	-
6	BR	-
7	BR	-
8	Y	-
9	R	-
10	W	-
11	GR	-
12	R	-
13	L	-
14	G	-
15	P	-
16	W	-
17	BR	-
18	V	-
19	BG	-
20	L	-
30	R	-
31	L	-
32	V	-
33	GR	-
34	P	-
35	BR	-
36	BR	-
37	Y	-
38	LG	-
39	SB	-
40	G	-
41	W	-
42	LG	-
43	P	-
44	GR	- [With A/T]
44	R	- [With M/T]
45	BG	-
46	G	-
47	P	-

48	P	-
49	L	-
59	B	-
66	Y	-
67	G	-
68	R	-
69	W	-
70	G	-
80	SB	-
81	R	-
82	V	-
83	W	-
84	L	-
85	BG	-
86	G	-
87	V	-
88	B	-
89	SB	-
90	G	-
91	W	-
92	B	-
93	G	-
94	L	-
95	BR	-
97	P	-
98	SHIELD	-
99	V	-
100	SB	-

A
B
C
D
E
F
G
H
I
J
K
L
M
N
O
P

SEC

JCKWM5272GB

INFINITI VEHICLE IMMOBILIZER SYSTEM-NATS

< DTC/CIRCUIT DIAGNOSIS >

INFINITI VEHICLE IMMOBILIZER SYSTEM

Connector No.	M7
Connector Name	WIRE TO WIRE
Connector Type	TH80MW-CS16-TM4



44	Y	-	-
45	BR	-	-
46	SB	-	-
47	SB	-	-
48	LG	-	-
49	LG	-	- [With BOSE system]
49	SB	-	- [Without BOSE system]
50	SB	-	- [With BOSE system]
50	LG	-	- [Without BOSE system]
51	R	-	-
52	V	-	-
53	P	-	-
54	BR	-	-
55	Y	-	- [With A/T]
55	BG	-	- [With M/T]
56	L	-	-
57	V	-	-
58	R	-	-
60	LG	-	-
61	BG	-	-
62	B	-	-
63	V	-	-
64	SB	-	-
65	BR	-	-
66	Y	-	-
67	P	-	-
68	L	-	-
69	P	-	-
70	L	-	-
80	G	-	-
81	LG	-	-
82	Y	-	-
83	BR	-	-
84	V	-	-
85	L	-	-
86	Y	-	-
87	GR	-	-
81	R	-	-
83	G	-	-
94	P	-	-
95	GR	-	-
96	Y	-	-
97	SB	-	-
99	Y	-	-
100	Y/B	-	-

3	W	DATA
5	Y	ILL BATT
6	LG	ILL
7	B	CLD
11	SB	KEY SWITCH SIGNAL

Connector No.	M24
Connector Name	DATA LINK CONNECTOR
Connector Type	ED16FW

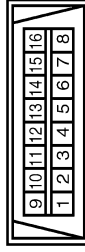

Terminal No.	Color of Wire	Signal Name [Specification]
3	LG	-
4	B	-
5	BR	-
6	L	-
7	V	-
8	G	-
11	SB	-
14	P	-
16	R	-

Connector No.	M17
Connector Name	WIRE TO WIRE
Connector Type	TKG2FW



Terminal No.	Color of Wire	Signal Name [Specification]
1	L	-
2	P	-

Connector No.	M18
Connector Name	WIRE TO WIRE
Connector Type	TKG2MW



Terminal No.	Color of Wire	Signal Name [Specification]
1	L	-
2	P	-

Connector No.	M22
Connector Name	KEY SLOT
Connector Type	TH12FW-NH

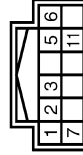

Terminal No.	Color of Wire	Signal Name [Specification]
1	V	BAT
2	GR	CLOCK

Terminal No.	Color of Wire	Signal Name [Specification]
1	BG	-
2	LG	-
3	G	-
4	V	-
5	L	-
6	B	-
8	L	-
9	BR	-
10	BR	-
12	SHIELD	-
13	V	-
14	BR	-
15	GR	-
16	LG	-
17	L	-
20	BR	-
21	G	-
22	R	-
23	SB	-
24	B	-
25	W	-
26	Y	-
27	V	-
28	P	-
29	V	-
31	SHIELD	-
32	G	-
33	R	-
34	BG	-
35	GR	-
36	BR	-
37	P	- [With climate controlled seat]
37	L	- [Without climate controlled seat]
38	V	- [With climate controlled seat]
38	GR	- [Without climate controlled seat]
40	SHIELD	-
41	L	-
42	P	-
43	SHIELD	-

JCKWM5273GB

INFINITI VEHICLE IMMOBILIZER SYSTEM-NATS

< DTC/CIRCUIT DIAGNOSIS >

INFINITI VEHICLE IMMOBILIZER SYSTEM

Connector No.	M40
Connector Name	STEERING LOCK UNIT
Connector Type	TH08FV-NH

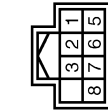

Terminal No.	Color of Wire	Signal Name [Specification]
1	BR	S/L 12V (MECHANICAL)
2	Y	S/L (K LINE)
3	L	S/L CONDITION 1
4	B	GND
5	B	GND
6	B	S/L 12V (CPU)
7	W	S/L CONDITION 2
8	SB	

Connector No.	M50
Connector Name	PUSH-BUTTON IGNITION SWITCH
Connector Type	TK08FB

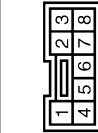

Terminal No.	Color of Wire	Signal Name [Specification]
1	B	
2	W	
3	Y	
4	BR	
5	LG	
6	BG	
7	V	
8	P	

Connector No.	M53
Connector Name	COMBINATION METER
Connector Type	SB40FV

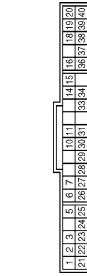

Terminal No.	Color of Wire	Signal Name [Specification]
1	V	BATTERY POWER SUPPLY
2	LG	COMMUNICATION SIGNAL (METER->AMP.)
3	GR	COMMUNICATION SIGNAL (AMP->METER)
4	B	GROUND
5	B	GROUND
6	W	ALTERNATOR SIGNAL
7	LG	AIR BAG SIGNAL
8	R	SECURITY SIGNAL
9	B	GROUND
10	B	GROUND
11	GR	METER CONTROL SWITCH GROUND
12	GR	ILL GND
13	GR	ILL GND
14	B	ILL
15	B	ILL
16	B	IGNITION SIGNAL
17	R	GROUND
18	B	COMMUNICATION SIGNAL (LCD->AMP.)
19	B	COMMUNICATION SIGNAL (AMP->LCD)
20	R	VEHICLE SPEED SIGNAL (8-PULSE)
21	R	PARKING BRAKE SWITCH SIGNAL
22	B	BRAKE FLUID LEVEL SWITCH SIGNAL
23	SB	SEAT BELT BUCKLE SW SIGNAL (DRIVER SIDE)
24	SB	SEAT BELT BUCKLE SW SIGNAL (PASSENGER SIDE)
25	B	WASHER LEVEL SWITCH SIGNAL
26	B	ILLUMINATION CONTROL SIGNAL
27	R	SELECT SWITCH SIGNAL
28	R	ENTER SWITCH SIGNAL
29	L	TRIP A / B RESET SWITCH SIGNAL
30	L	ILLUMINATION CONTROL SWITCH (-)
31	L	ILLUMINATION CONTROL SWITCH (+)
32	R	
33	LG	
34	LG	
35	SB	
36	L	
37	P	
38	BG	
39	BG	
40	BG	

Connector No.	M66
Connector Name	UNIFIED METER AND A / C AMP.
Connector Type	TH08FV-NH

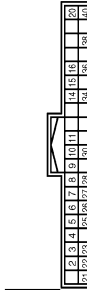

Terminal No.	Color of Wire	Signal Name [Specification]
4	G	STOP LAMP SWITCH
5	L	MANUAL MODE SHIFT UP SIGNAL
6	BG	PADDLE SHIFTER UP SIGNAL
7	GR	COMMUNICATION SIGNAL (AMP->METER)
8	L	VEHICLE SPEED (2-PULSE)
9	SB	SEAT BELT BUCKLE SWITCH SIGNAL (DRIVER SIDE)
10	W	MANUAL MODE SIGNAL
11	G	NON-MANUAL MODE SIGNAL
12	G	COMMUNICATION SIGNAL (LCD->AMP.)
13	G	ION ON / OFF SIGNAL
14	G	MANUAL MODE SHIFT DOWN SIGNAL
15	V	PADDLE SHIFTER DOWN SIGNAL
16	G	COMMUNICATION SIGNAL (METER->AMP.)
17	R	VEHICLE SPEED (8-PULSE)
18	R	PARKING BRAKE SWITCH SIGNAL
19	B	COMMUNICATION SIGNAL (AMP->LCD)
20	B	COMMUNICATION SIGNAL (AMP->LCD)
21	P	BLOWER MOTOR CONTROL SIGNAL

Connector No.	M67
Connector Name	UNIFIED METER AND A / C AMP.
Connector Type	TH08FV-NH

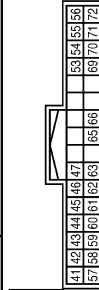

Terminal No.	Color of Wire	Signal Name [Specification]
41	BR	ACC POWER SUPPLY
42	BR	FUEL LEVEL SENSOR SIGNAL
43	R	INTAKE SENSOR SIGNAL
44	LG	IN-VEHICLE SENSOR SIGNAL
45	V	AMBIENT SENSOR SIGNAL

46	BG	SUNLOAD SENSOR SIGNAL
47	G	EXHAUST GAS O2 SENSOR REFERENCE SENSOR SIGNAL
53	W	IGNITION POWER SUPPLY
54	BG	BATTERY POWER SUPPLY
55	B	GROUND
56	L	CAN-H
57	LG	BRAKE FLUID LEVEL SWITCH SIGNAL
58	Y	FUEL LEVEL SENSOR SIGNAL GROUND
59	GR	INTAKE SENSOR GROUND
60	L	IN-VEHICLE SENSOR GROUND
61	R	AMBIENT SENSOR GROUND
62	SB	SUNLOAD SENSOR GROUND
63	L	ION CONTROL MODE OUTPUT SIGNAL
65	BG	ECV SIGNAL
69	L	A / C LAM SIGNAL
70	R	EACH DOOR MOTOR POWER SUPPLY
71	GR	GROUND
72	P	CAN-L

A
B
C
D
E
F
G
H
I
J
K
L
M
N
O
P

SEC

INFINITI VEHICLE IMMOBILIZER SYSTEM-NATS

< DTC/CIRCUIT DIAGNOSIS >

INFINITI VEHICLE IMMOBILIZER SYSTEM

Connector No.	M107
Connector Name	ECM
Connector Type	RH24FGY-R26-R-LH-Z

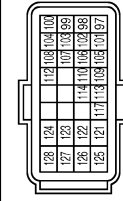

Terminal No.	Color of Wire	Signal Name [Specification]
97	R	APP SEN 1
98	P	APP SEN 2
99	L	SENSOR POWER SUPPLY
100	W	SENSOR GROUND
101	SB	ASCD/ICC STEERING SW
102	G	EVAP CONTROL SYSTEM PRESS SEN
103	G	SENSOR POWER SUPPLY
104	GR	SENSOR GROUND
105	L	REFRIGERANT PRESS SEN
106	LG	FUEL TANK TEMP SEN
107	BR	SENSOR POWER SUPPLY
108	Y	SENSOR GROUND
109	G	PNP SIGNAL
110	BR	ENGINE SPEED OUTPUT SIGNAL
112	R	SENSOR GROUND
113	P	CAN COMMUNICATION LINE
114	L	CAN COMMUNICATION LINE
117	V	DATA LINK CONNECTOR
121	LG	EVAP CANISTER VENT CONTROL VALVE
122	P	STOP LAMP SW
123	B	ECM GROUND
124	B	ECM GROUND
125	B	POWER SUPPLY FOR ECM
126	BR	ASCD/ICC BRAKE SW
127	B	ECM GROUND
128	B	ECM GROUND

Connector No.	M116
Connector Name	WIRE TO WIRE
Connector Type	TK38MPV-NS10

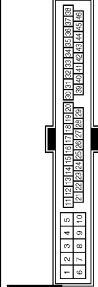

Terminal No.	Color of Wire	Signal Name [Specification]
2	W	
3	BG	
4	R	
5	B	
9	R	
10	R	
19	BG	
20	Y	
28	GR	
29	LG	
30	LG	
31	W	
41	BG	
42	G	
43	P	
44	L	
45	G	
46	Y	

Connector No.	M118
Connector Name	BCM (BODY CONTROL MODULE)
Connector Type	M03FB-LC



Terminal No.	Color of Wire	Signal Name [Specification]
1	W	BAT (F/L)
2	Y	POWER WINDOW POWER SUPPLY (BAT)
3	BG	POWER WINDOW POWER SUPPLY (RAP)

Connector No.	M119
Connector Name	BCM (BODY CONTROL MODULE)
Connector Type	NS18FW-CS

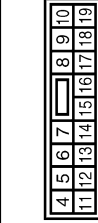

Terminal No.	Color of Wire	Signal Name [Specification]
4	LG	INTERIOR ROOM LAMP POWER SUPPLY
5	P	PASSENGER DOOR UNLOCK OUTPUT
7	SB	STEP LAMP
8	V	ALL DOOR FUEL LID LOCK OUTPUT
9	G	DRIVER DOOR FUEL LID UNLOCK OUTPUT
11	GR	BAT (FUSE)
13	B	GND
14	W	PUSH-BUTTON IGNITION SW (LL GND)
15	BG	ACC IND
17	BR	TURN SIGNAL RH (FRONT)
18	BG	TURN SIGNAL LH (FRONT)
19	V	ROOM LAMP TIMER CONTROL

Connector No.	M121
Connector Name	BCM (BODY CONTROL MODULE)
Connector Type	TH40FGY-NH



Terminal No.	Color of Wire	Signal Name [Specification]
34	SB	TRUNK ROOM ANT-
35	V	TRUNK ROOM ANT+
38	B	REAR BUMPER ANT-
39	W	REAR BUMPER ANT+
47	Y	IGN RELAY (PDM E/R) CONT
50	G	TRUNK ROOM LAMP SW
52	BR	STARTER RELAY CONT
60	BR	PUSH SW
61	SB	TRUNK LID OPENER REQUEST SW
64	G	F-KEY WARN BUZZER (ENG ROOM)

Connector No.	M122
Connector Name	BCM (BODY CONTROL MODULE)
Connector Type	TH40FB-NH



Terminal No.	Color of Wire	Signal Name [Specification]
72	R	ROOM ANT 2+
73	G	ROOM ANT 2-
74	SB	PASSENGER DOOR ANT-
75	BR	PASSENGER DOOR ANT+
76	V	DRIVER DOOR ANT-
77	LG	DRIVER DOOR ANT+
78	Y	ROOM ANT 1-
79	BR	ROOM ANT 1+
80	GR	NATS-ANTENNA AMP
81	W	NATS-ANTENNA AMP
82	R	IGN RELAY (F/B) CONT
83	Y	KEYLESS ENTRY RECEIVER COMM
87	Y	COMBI SW INPUT 5
88	BG	COMBI SW INPUT 3
89	BR	PUSH SW
90	P	CAN-L
91	L	CAN-H
92	LG	KEY SLOT ILL
93	V	ON IND
95	BG	ACC RELAY CONT
96	GR	A/T SHIFT SELECTOR POWER SUPPLY
97	L	S/L CONDITION 1
98	SB	S/L CONDITION 2
99	R	ASCD CLUTCH SW [With M/T]
99	R	SHIFT P [With A/T]
100	Y	PASSENGER DOOR REQUEST SW
101	P	DRIVER DOOR REQUEST SW
102	BG	BLOWER FAN MOTOR RELAY CONT
103	LG	KEYLESS ENTRY RECEIVER POWER SUPPLY
106	W	S/L UNIT POWER SUPPLY
107	LG	COMBI SW INPUT 1
108	R	COMBI SW INPUT 4
109	W	COMBI SW INPUT 2
110	G	HAZARD SW
111	Y	S/L UNIT COMM

INFINITI VEHICLE IMMOBILIZER SYSTEM-NATS

< DTC/CIRCUIT DIAGNOSIS >

INFINITI VEHICLE IMMOBILIZER SYSTEM

Connector No.	M123
Connector Name	BCM (BODY CONTROL MODULE)
Connector Type	TH40FG-NH



Terminal No.	Color of Wire	Signal Name [Specification]
112	BR	RAIN SENSOR SERIAL LINK
113	G	OPTICAL SENSOR
114	R	CLUTCH INTERLOCK SW
116	SB	STOP LAMP SW 1
118	BR	STOP LAMP SW 2
119	GR	DR DOOR UNLOCK SENSOR
121	SB	KEY SLOT SW
121	W	IGN P/B
124	BG	PASSENGER DOOR SW
129	BG	TRUNK LID OPENER CANCEL SW
132	LG	P/W SW & RHT C/U COMM
133	Y	PUSH-BUTTON IGNITION SW ILL POWER
134	LG	LOCK IND
137	BG	RECEIVER / SENSOR GND
138	Y	RECEIVER / SENSOR POWER SUPPLY
139	L	TIRE PRESSURE RECEIVER COMM
140	GR	SHIFT N/P
141	R	SECURITY INDICATOR LAMP
142	BR	COMBI SW OUTPUT 5
143	V	COMBI SW OUTPUT 1
144	G	COMBI SW OUTPUT 2
145	L	COMBI SW OUTPUT 3
146	SB	COMBI SW OUTPUT 4
150	R	DRIVER DOOR SW
151	G	REAR WINDOW DEFOGGER RELAY CONT

Connector No.	M137
Connector Name	A/T SHIFT SELECTOR
Connector Type	TH12F1P-NH



Terminal No.	Color of Wire	Signal Name [Specification]
1	W	-
2	V	-
3	L	-
4	BR	-
5	G	-
7	Y	-
8	SB	-
9	B	-
10	GR	-
11	R	-

A
B
C
D
E
F
G
H
I
J
L
M
N
O
P

SEC

JCKWM5276GB

VEHICLE SECURITY SYSTEM

< DTC/CIRCUIT DIAGNOSIS >

VEHICLE SECURITY SYSTEM

Wiring Diagram - VEHICLE SECURITY SYSTEM -

INFOID:000000006956349

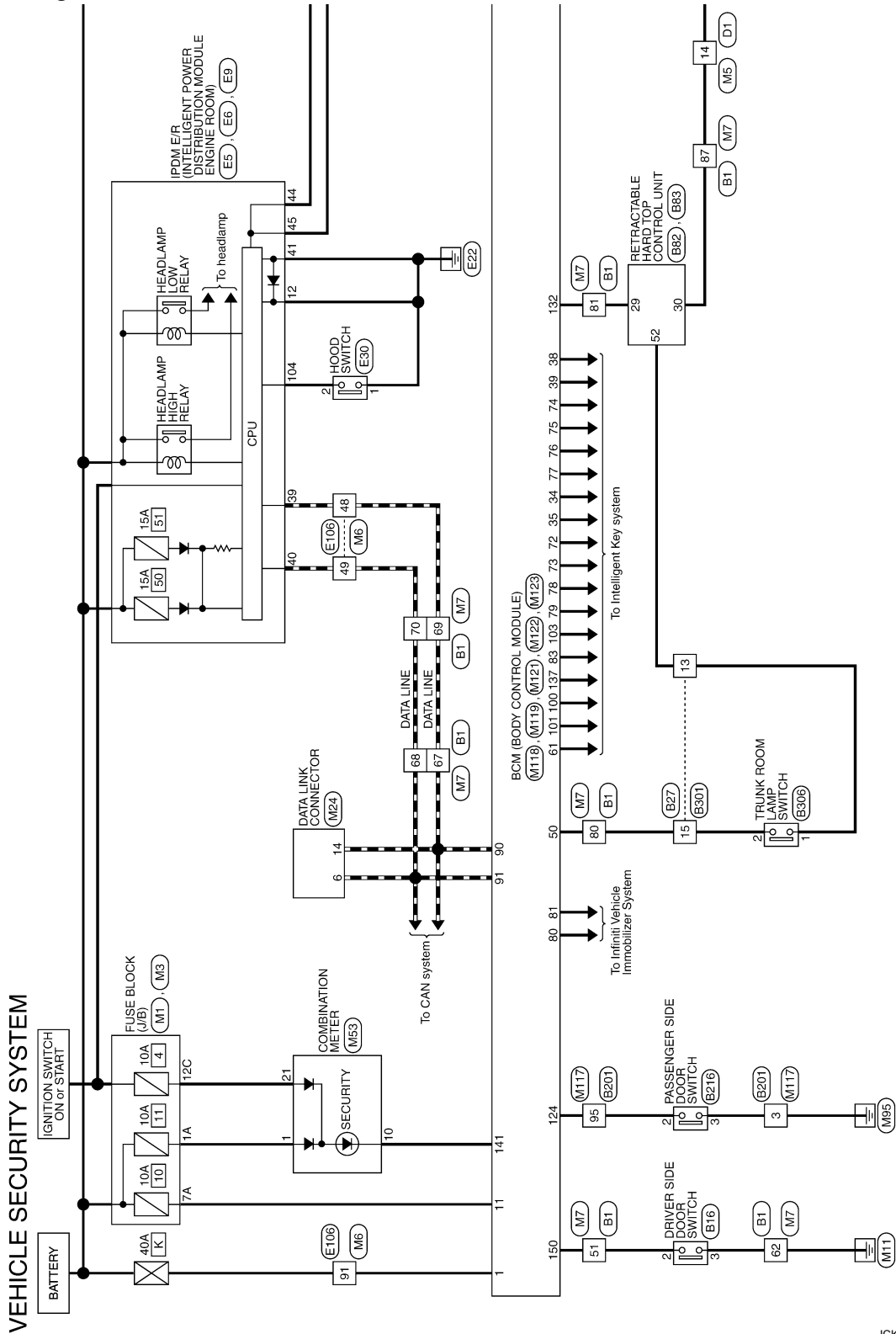

2010/10/12

JCKWM5256GB

VEHICLE SECURITY SYSTEM

< DTC/CIRCUIT DIAGNOSIS >

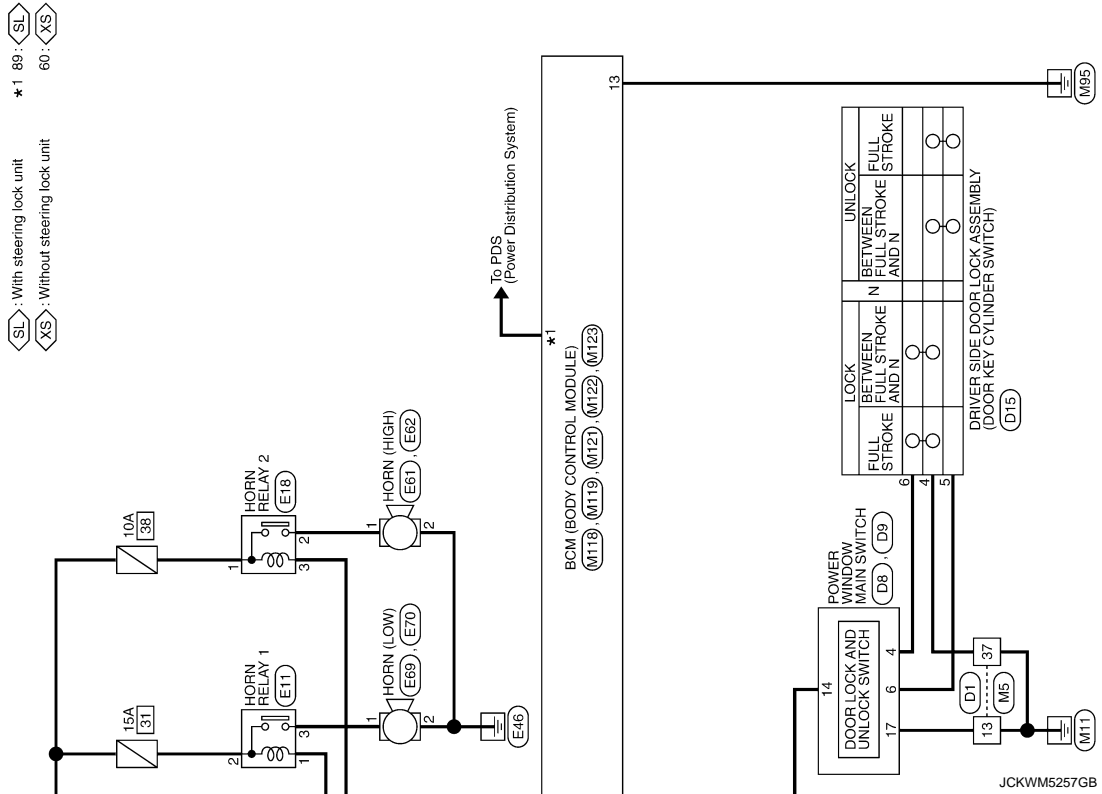

A
B
C
D
E
F
G
H
I
J
L
M
N
O
P

SEC

VEHICLE SECURITY SYSTEM

< DTC/CIRCUIT DIAGNOSIS >

VEHICLE SECURITY SYSTEM

Connector No.	B1
Connector Name	WIRE TO WIRE
Connector Type	TH807V-CS16-TM4



Terminal No.	Color of Wire	Signal Name [Specification]
1	W	-
2	L	-
3	R	-
4	V	-
5	W	-
6	B	-
8	G	-
10	BR	-
12	SHIELD	-
13	Y	-
14	L	-
15	R	-
16	W	-
17	BR	-
20	G	-
21	SB	-
22	GR	-
23	W	-
24	SB	-
25	BR	-
26	LG	-
27	Y	-
28	R	-
29	V	-
31	SHIELD	-
32	G	-
33	R	-
34	BG	-
35	GR	-
36	BR	-
37	P	- [With climate controlled seat]
37	Y	- [Without climate controlled seat]
38	V	- [With climate controlled seat]
38	GR	- [Without climate controlled seat]
40	SHIELD	-
41	L	-
42	P	-
43	SHIELD	-

44	SB	-
45	V	-
46	W	-
47	SB	-
48	LG	-
49	LG	- [With BOSE system]
49	Y	- [Without BOSE system]
50	SB	-
50	LG	- [With BOSE system]
50	LG	- [Without BOSE system]
51	SB	-
52	G	-
53	LG	-
54	BR	-
55	Y	-
56	W	-
57	V	-
58	R	-
60	R	-
61	BG	-
62	B	-
63	L	-
64	P	-
65	B	-
66	SB	-
67	P	-
68	L	-
69	P	-
70	L	-
80	G	-
81	V	-
82	R	-
83	BR	-
84	G	-
85	L	-
86	Y	-
87	GR	-
91	R	-
93	BG	-
94	P	-
95	GR	-
96	GR	-
97	SB	-
99	Y	-
100	Y/B	-

Connector No.	B16
Connector Name	DRIVER SIDE DOOR SWITCH
Connector Type	A03FW

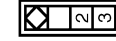

Terminal No.	Color of Wire	Signal Name [Specification]
1	G	-
2	SB	-
3	B	-

Connector No.	B27
Connector Name	WIRE TO WIRE
Connector Type	MS18MW-CS



Terminal No.	Color of Wire	Signal Name [Specification]
1	BG	-
2	P	-
3	G	-
4	W	-
5	R	-
6	B	-
7	GR	-
10	LG	-
11	B	-
12	B	-
13	V	-
14	SB	-
15	L	-
16	V	-

Connector No.	B82
Connector Name	RETRACTABLE HARD TOP CONTROL UNIT
Connector Type	TH40FW-NH



Terminal No.	Color of Wire	Signal Name [Specification]
1	G	ROOF OPEN / CLOSE SWITCH (OPEN)
2	BR	ROOF OPEN / CLOSE SWITCH (CLOSE)
3	B	FLIPPER DOOR LIMIT SWITCH (GND)
4	L	TOWNEAU BOARD SWITCH
5	SB	TRUNK ROOM LAMP SWITCH
6	L	ROOF LATCH LIMIT SWITCH
7	W	FLIPPER DOOR LIMIT SWITCH (UP)
8	G	FLIPPER DOOR LIMIT SWITCH (DOWN)
11	W	RETAINED ACC POWER
12	Y	REVERSE SIGNAL
13	BG	PARCEL SHELF STATUS SENSOR POWER SUPPLY
14	P	TRUNK LINK SENSOR SIGNAL (LH)
15	SB	TRUNK LINK SENSOR SIGNAL (RH)
16	GR	ROOF LATCH STATUS SENSOR SIGNAL
17	G	ROOF LATCH LOCK SENSOR SIGNAL
18	LG	TRUNK STATUS SENSOR SIGNAL
22	V	ROOF STATUS SENSOR POWER SUPPLY
23	B	ROOF STATUS SENSOR GND
24	GR	PARCEL SHELF STATUS SENSOR SIGNAL (DRAW)
25	R	PARCEL SHELF STATUS SENSOR SIGNAL (ROTATION)
26	P	ROOF STATUS SENSOR SIGNAL
27	Y	TRUNK LID OPEN REQUEST SIGNAL
28	BG	FLIPPER DOOR RELAY GND
29	V	LOCAL COMMUNICATION (ESM)
30	GR	LOCAL COMMUNICATION (POWER WINDOW)
31	L	CAN-H
32	P	-
33	V	ROOF STATUS SIGNAL (AUDIO)
35	B	ROOF WARNING BUZZER
36	Y	HYDRAULIC MOTOR RELAY GND (RH)
37	W	HYDRAULIC MOTOR RELAY GND (LH)
38	BR	HYDRAULIC MOTOR RELAY POWER SUPPLY

JCKWM5258GB

VEHICLE SECURITY SYSTEM

< DTC/CIRCUIT DIAGNOSIS >

VEHICLE SECURITY SYSTEM

Connector No.	B83
Connector Name	RETRACTABLE HARD TOP CONTROL UNIT
Connector Type	MS16FR-CS



47	46	45	44	43	42	41
56	55	54	53	52	51	50
49	48	47	46	45	44	43
42	41	40	39	38	37	36

Terminal No.	Color of Wire	Signal Name [Specification]
41	SB	PARCEL SHELF MOTOR RELAY GND (UP)
42	W	PARCEL SHELF MOTOR RELAY GND (DOWN)
43	BR	HYDRAULIC PUMP POWER SUPPLY RELAY
44	R	MOTOR PARCEL SHELF (HORIZONTAL)
45	BR	MOTOR PARCEL SHELF (VERTICAL)
46	G	FLIPPER DOOR RELAY POWER SUPPLY (UP)
47	L	FLIPPER DOOR RELAY POWER SUPPLY (DOWN)
48	R	ROOF LATCH MOTOR (OPEN)
49	Y	ROOF LATCH MOTOR (CLOSE)
51	SB	TRUNK OPENER ACTUATOR
52	V	TRUNK OPENER ACTUATOR GND
53	EG	REAR POWER WINDOW MOTOR LH (UP)
54	LG	REAR POWER WINDOW MOTOR LH (DOWN)
55	GR	REAR POWER WINDOW MOTOR RH (UP)
56	P	REAR POWER WINDOW MOTOR RH (DOWN)

Connector No.	B201
Connector Name	WIRE TO WIRE
Connector Type	TH80FY-CS16-TM4



16	15	14	13	12	11	10	9	8	7	6	5	4	3	2	1
----	----	----	----	----	----	----	---	---	---	---	---	---	---	---	---

Terminal No.	Color of Wire	Signal Name [Specification]
1	W	-
3	B	-
5	W	-
6	R	-
7	B	- [With climate controlled seat]
8	EG	- [Without climate controlled seat]

9	GR	-
10	LG	-
40	GR	-
41	LG	-
42	EG	-
43	R	-
44	SHIELD	-
45	G	-
47	G	-
48	Y	-
49	SHIELD	-
50	P	-
51	SB	-
52	LG	-
53	L	-
54	G	-
55	GR	-
56	LG	-
57	G	-
58	R	-
67	L	-
68	P	-
80	G	-
81	R	-
82	W	-
83	B	-
84	SHIELD	-
85	O	-
86	BR	-
87	Y	-
88	SHIELD	-
89	SB	-
90	V	-
91	GR	-
92	P	- [With BOSE system]
92	Y	- [Without BOSE system]
93	L	-
94	SB	-
95	V	-
96	P	-
97	L	- [With BOSE system]
97	LG	- [Without BOSE system]
98	Y/B	-
99	Y	-

Connector No.	B216
Connector Name	PASSENGER SIDE DOOR SWITCH
Connector Type	A03FW



2	3
---	---

Terminal No.	Color of Wire	Signal Name [Specification]
2	V	-
3	B	-

Connector No.	B301
Connector Name	WIRE TO WIRE
Connector Type	MS16FW-CS



7	6	5	4	3	2	1
16	15	14	13	12	11	10
9	8	7	6	5	4	3

Terminal No.	Color of Wire	Signal Name [Specification]
1	R	-
2	GR	-
3	G	-
4	W	-
5	Y	-
6	P	-
7	P	-
10	LG	-
11	B	-
12	B	-
13	V	-
14	BR	-
15	L	-
16	Y	-

Connector No.	E306
Connector Name	TRUNK ROOM LAMP SWITCH
Connector Type	A02FW



1	2
---	---

Terminal No.	Color of Wire	Signal Name [Specification]
1	V	SIG-
2	L	SIG+

A
B
C
D
E
F
G
H
I
J
K
L
M
N
O
P

SEC

VEHICLE SECURITY SYSTEM

< DTC/CIRCUIT DIAGNOSIS >

VEHICLE SECURITY SYSTEM

Connector No.	D1
Connector Name	WIRE TO WIRE
Connector Type	TH40FW-CS15

15	14	13	12	11	10	9	8	7	6	5	4	3	2	1
42	41	40	39	38	37	36	35	34	33	32	31	30	29	28
27	26	25	24	23	22	21	20	19	18	17	16	15	14	13
12	11	10	9	8	7	6	5	4	3	2	1			

Terminal No.	Color of Wire	Signal Name [Specification]
4	BR	-
5	P	- [A/T models with automatic drive position]
6	SB	- [Except for A/T models with automatic drive position]
7	R	-
8	G	-
9	P	-
10	LG	-
11	W	-
12	L	-
13	B	-
14	V	-
15	Y	-
16	Y/B	-
17	Y	-
20	V	-
21	R	-
22	P	-
23	O	-
24	Y	-
25	SB	-
26	GR	-
27	GR	-
28	LG	-
29	G	-
30	Y	-
31	W	-
32	BR	-
33	L	-
34	R	-
35	V	-
37	B	-
38	O	-
39	GR	-
40	G	-
41	Y	-
42	LG	-
43	BR	-

44	V	-
45	P	-
46	W	-
47	V	-
48	P	-
49	W	-
50	SB	-
51	R	-
52	L	-

Connector No.	D8
Connector Name	POWER WINDOW MAIN SWITCH
Connector Type	NS16FW-CS

2	4	5	6
8	9	10	11
13	14	15	

Terminal No.	Color of Wire	Signal Name [Specification]
2	G	-
4	V	-
5	BR	-
6	W	-
8	L	-
9	W	-
10	SB	-
11	BR	-
13	R	-
14	V	-
15	BG	-

Connector No.	D9
Connector Name	POWER WINDOW MAIN SWITCH
Connector Type	NS50FW-CS

17	19
----	----

Terminal No.	Color of Wire	Signal Name [Specification]
--------------	---------------	-----------------------------

17	B	-
19	Y	-

Connector No.	D15
Connector Name	DRIVER SIDE DOOR LOCK ASSEMBLY
Connector Type	E06FGY-RS

1	2	3	4	5	6
---	---	---	---	---	---

Terminal No.	Color of Wire	Signal Name [Specification]
1	LG	-
2	P	-
3	L	-
4	B	-
5	W	-
6	V	-

Connector No.	E5
Connector Name	SPOLE R INTELLIGENT POWER DISTRIBUTION MODULE (ENGINE ROOM)
Connector Type	TH20FW-CS1Z-M4-IV

9	10	11	12	13	14
15	16	17	18	19	20
21	22	23	24	25	26
27	28	29	30	31	32

Terminal No.	Color of Wire	Signal Name [Specification]
4	V	-
5	L	-
6	SB	-
7	R	-
11	BR	-
12	B/W	-
13	Y	-
16	LG	-
19	W	-
25	G	-
26	R	-
27	BG	-

28	L	-
30	GR	-
32	V	-
33	P	-
36	G	-

Connector No.	E6
Connector Name	SPOLE R INTELLIGENT POWER DISTRIBUTION MODULE (ENGINE ROOM)
Connector Type	TH08FW-NH

42	41	40	39
46	45	44	43

Terminal No.	Color of Wire	Signal Name [Specification]
39	P	-
40	L	-
41	B/W	-
42	Y	-
43	SB	-
44	LG	-
45	G	-
46	W	-

Connector No.	E9
Connector Name	SPOLE R INTELLIGENT POWER DISTRIBUTION MODULE (ENGINE ROOM)
Connector Type	TH18FW-NH

89	97	96	95	94	93	92	91
108	105	104	103	102	101	100	99

Terminal No.	Color of Wire	Signal Name [Specification]
91	P	-
92	BG	-
97	V	-
104	LG	-
105	L	-

VEHICLE SECURITY SYSTEM

< DTC/CIRCUIT DIAGNOSIS >

VEHICLE SECURITY SYSTEM

Connector No.	E11
Connector Name	HORN RELAY 1
Connector Type	24381-7980A



Terminal No.	Color of Wire	Signal Name [Specification]
1	LG	-
2	SB	-
3	Y	-

Connector No.	E18
Connector Name	HORN RELAY 2
Connector Type	M02FW-R-LG



Terminal No.	Color of Wire	Signal Name [Specification]
1	P	-
2	Y	-
3	G	-

Connector No.	E30
Connector Name	HOOD SWITCH
Connector Type	RH02FB



Terminal No.	Color of Wire	Signal Name [Specification]
1	P	-
2	Y	-

1	B	-
2	LG	-

Connector No.	E61
Connector Name	HORN (HIGH)
Connector Type	P01FB-A



Terminal No.	Color of Wire	Signal Name [Specification]
1	Y	-

Connector No.	E62
Connector Name	HORN (HIGH)
Connector Type	P01FB-A



Terminal No.	Color of Wire	Signal Name [Specification]
2	B	-

Connector No.	E69
Connector Name	HORN (LOW)
Connector Type	P01FB-A



Terminal No.	Color of Wire	Signal Name [Specification]
1	B	-

1	Y	-
---	---	---

Connector No.	E70
Connector Name	HORN (LOW)
Connector Type	P01FB-A



Terminal No.	Color of Wire	Signal Name [Specification]
2	B	-

Connector No.	E106
Connector Name	WIRE TO WIRE
Connector Type	TH00FW-C516-TM4

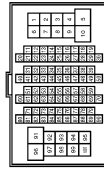

Terminal No.	Color of Wire	Signal Name [Specification]
1	GR	-
2	BG	-
3	B/W	-
4	G	-
5	BG	-
6	LG	-
7	GR	-
8	R	-
9	W	-
10	V	-
11	R	-
12	L	-
13	GR	-
14	GR	-
15	P	-
16	W	-
17	V	-
18	BG	-
19	GR	-

20	LG	-
30	R	-
31	L	-
32	BG	-
33	P	-
34	V	-
35	BR	-
36	W	-
37	Y	-
38	R	-
39	B	-
40	G	-
41	W	-
42	LG	-
43	SB	-
44	GR	-
45	BG	-
46	LG	-
47	V	-
48	P	-
49	L	-
59	B	-
66	LG	-
67	SB	-
68	R	-
69	W	-
70	G	-
80	W	-
81	P	-
82	G	-
83	V	-
84	L	-
85	BG	-
86	LG	-
87	Y	-
88	GR	-
89	W	-
90	W	-
91	G	-
92	B	-
93	GR	-
94	L	-
95	Y	-
97	BR	-
98	SHIELD	-
99	L	-
100	P	-

A
B
C
D
E
F
G
H
I
J
K
L
M
N
O
P

SEC

JCKWM5261GB

VEHICLE SECURITY SYSTEM

< DTC/CIRCUIT DIAGNOSIS >

VEHICLE SECURITY SYSTEM

Connector No.	M1
Connector Name	FUSE BLOCK (J/B)
Connector Type	NS08FW-MZ



Terminal No.	Color of Wire	Signal Name [Specification]
1A	V	-
2A	G	-
3A	L	-
4A	P	-
5A	BR	-
6A	Y	-
7A	GR	-
8A	L	-

Connector No.	M3
Connector Name	FUSE BLOCK (J/B)
Connector Type	NS12FW-CS

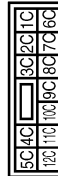

Terminal No.	Color of Wire	Signal Name [Specification]
1C	R	-
2C	B	-
3C	W	-
4C	BG	-
5C	L	-
6C	LG	-
7C	R	-
8C	R	-

Connector No.	M5
Connector Name	WIRE TO WIRE
Connector Type	TH40MW-CS15

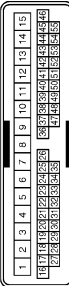

Terminal No.	Color of Wire	Signal Name [Specification]
4	R	-
5	B	-
6	BG	-
7	W	-
8	B	-
9	G	-
10	V	-
11	W	-
12	L	-
13	B	-
14	GR	-
15	Y	-
16	Y/B	-
17	Y	-
20	BG	-
21	W	-
22	P	-
23	BG	-
24	V	-
25	BR	-
26	R	-
27	P	-
28	LG	-
29	SS	-
30	G	-
31	V	-
32	BR	-
33	GR	-
34	G	-
35	L	-
37	B	-
38	G	- [With automatic drive positioner]
38	L	- [Without automatic drive positioner]
39	BR	- [With automatic drive positioner]
39	L	- [Without automatic drive positioner]
40	Y	-
41	BR	- [With automatic drive positioner]
41	G	- [Without automatic drive positioner]

42	R	-
43	G	-
44	V	-
45	GR	-
46	BR	-
47	V	-
48	LG	-
49	P	-
50	SB	-
51	GR	-
52	L	-

Connector No.	M6
Connector Name	WIRE TO WIRE
Connector Type	TH60MW-CS16-TM4

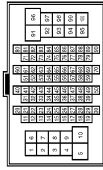

Terminal No.	Color of Wire	Signal Name [Specification]
1	BG	-
3	R	-
4	G	-
5	G	-
6	BR	-
7	BR	-
8	Y	-
9	R	-
10	W	-
11	GR	-
12	R	-
13	L	-
14	G	-
15	P	-
16	W	-
17	BR	-
18	V	-
19	BG	-
20	L	-
30	R	-
31	L	-
32	Y	-
33	GR	-
34	P	-
35	BR	-

36	BR	-
37	Y	-
38	LG	-
39	SS	-
40	G	-
41	W	-
42	LG	-
43	P	-
44	GR	- [With A/T]
44	R	- [With M/T]
45	BG	-
46	G	-
47	P	-
48	P	-
49	L	-
59	B	-
66	Y	-
67	G	-
68	R	-
69	W	-
70	G	-
80	SB	-
81	R	-
82	V	-
83	W	-
84	L	-
85	BG	-
86	G	-
87	V	-
88	B	-
89	SS	-
90	G	-
91	W	-
92	B	-
93	G	-
94	L	-
95	BR	-
97	P	-
98	SHIELD	-
99	V	-
100	SB	-

JCKWM5262GB

VEHICLE SECURITY SYSTEM

< DTC/CIRCUIT DIAGNOSIS >

VEHICLE SECURITY SYSTEM

Connector No.	M7
Connector Name	WIRE TO WIRE
Connector Type	THORNW-CSE-TM4



Terminal No.	Color of Wire	Signal Name [Specification]
1	BG	-
2	LG	-
3	G	-
4	Y	-
5	L	-
6	B	-
7	L	-
8	L	-
9	L	-
10	BR	-
11	SHIELD	-
12	SHIELD	-
13	V	-
14	BR	-
15	GR	-
16	LG	-
17	L	-
18	BR	-
19	G	-
20	G	-
21	R	-
22	R	-
23	SB	-
24	B	-
25	W	-
26	Y	-
27	V	-
28	P	-
29	V	-
30	SHIELD	-
31	SHIELD	-
32	G	-
33	R	-
34	BG	-
35	GR	-
36	BR	-
37	P	- [With climate controlled seat]
38	V	- [Without climate controlled seat]
39	V	- [With climate controlled seat]
40	SHIELD	- [Without climate controlled seat]
41	L	-
42	P	-
43	SHIELD	-

44	Y	-
45	BR	-
46	SB	-
47	SB	-
48	LG	-
49	LG	- [With BOSE system]
50	SB	- [Without BOSE system]
51	LG	- [With BOSE system]
52	LG	- [Without BOSE system]
53	V	-
54	P	-
55	Y	- [With A/T]
56	BG	- [With M/T]
57	L	-
58	R	-
59	R	-
60	LG	-
61	BG	-
62	B	-
63	V	-
64	SB	-
65	BR	-
66	Y	-
67	P	-
68	L	-
69	P	-
70	L	-
80	G	-
81	LG	-
82	Y	-
83	BR	-
84	V	-
85	L	-
86	Y	-
87	GR	-
88	R	-
89	G	-
90	P	-
91	R	-
92	G	-
93	G	-
94	P	-
95	GR	-
96	Y	-
97	SB	-
98	Y	-
99	Y/B	-
100	Y/B	-

Connector No.	M24
Connector Name	DATA LINK CONNECTOR
Connector Type	BD16FN



Terminal No.	Color of Wire	Signal Name [Specification]
3	LG	-
4	B	-
5	BR	-
6	L	-
7	V	-
8	G	-
11	SB	-
14	P	-
18	R	-

Connector No.	M53
Connector Name	COMBINATION METER
Connector Type	SAB40FW

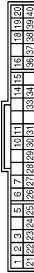

Terminal No.	Color of Wire	Signal Name [Specification]
1	V	BATTERY POWER SUPPLY
2	LG	COMMUNICATION SIGNAL (METER->AMP.)
3	GR	COMMUNICATION SIGNAL (AMP->METER)
5	B	GROUND
6	W	ALTERNATOR SIGNAL
7	LG	AIR BAG SIGNAL
10	R	SECURITY SIGNAL
15	B	GROUND
16	B	METER CONTROL SWITCH GROUND
18	GR	ILL GND
19	B	ILL GND
20	R	ILL
21	R	IGNITION SIGNAL

22	B	GROUND
24	SB	COMMUNICATION SIGNAL (LCD->AMP.)
25	B	COMMUNICATION SIGNAL (AMP->LCD)
26	R	VEHICLE SPEED SIGNAL (P-PULSE)
27	V	PARKING BRAKE SWITCH SIGNAL
28	SB	BRAKE FLUID LEVEL SWITCH SIGNAL
29	L	SEAT BELT BUCKLE SW SIGNAL (DRIVER SIDE)
30	G	SEAT BELT BUCKLE SWITCH SIGNAL (PASSENGER SIDE)
31	L	WASHER LEVEL SWITCH SIGNAL
33	R	ILLUMINATION CONTROL SIGNAL
36	LG	SELECT SWITCH SIGNAL
37	SB	ENTER SWITCH SIGNAL
38	L	TRIP A/B RESET SWITCH SIGNAL
39	P	ILLUMINATION CONTROL SWITCH (-)
40	BG	ILLUMINATION CONTROL SWITCH (+)

JCKWM5263GB

A
B
C
D
E
F
G
H
I
J
K
L
M
N
O
P

SEC

VEHICLE SECURITY SYSTEM

< DTC/CIRCUIT DIAGNOSIS >

VEHICLE SECURITY SYSTEM

Connector No.	M117
Connector Name	WIRE TO WIRE
Connector Type	THB0MW-CS (E-TM4)

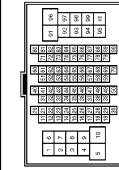

Terminal No.	Color of Wire	Signal Name [Specification]
1	Y	-
3	B	-
5	SB	-
6	R	-
7	G	-
8	SB	-
9	GR	-
10	LG	-
40	Y	-
41	G	-
42	LG	-
44	SHIELD	-
45	G	-
47	P	-
48	L	-
49	SHIELD	-
50	V	-
51	SB	-
52	BG	-
53	L	-
54	G	-
55	Y	-
56	LG	-
57	SB	-
58	LG	-
67	SB	-
68	LG	-
80	W	-
81	B	-
82	R	-
83	G	-
84	SHIELD	-
85	G	-
86	L	-
87	P	-
88	SHIELD	-
88	Y	-

90	W	-
91	GR	-
92	P	-
93	W	-
94	BG	-
95	BG	-
96	P	-
97	L	-
98	Y/B	-
99	Y	-

Connector No.	M118
Connector Name	BCM (BODY CONTROL MODULE)
Connector Type	M03FB-LC



Terminal No.	Color of Wire	Signal Name [Specification]
1	W	BAT (F/L)
2	Y	POWER WINDOW POWER SUPPLY (BAT)
3	BG	POWER WINDOW POWER SUPPLY (RAP)

Connector No.	M119
Connector Name	BCM (BODY CONTROL MODULE)
Connector Type	NS10FW-CS



Terminal No.	Color of Wire	Signal Name [Specification]
4	LG	INTERIOR ROOM LAMP POWER SUPPLY
5	P	PASSENGER DOOR UNLOCK OUTPUT
7	SB	STEP LAMP
8	V	ALL DOOR FUEL LID LOCK OUTPUT
9	G	DRIVER DOOR FUEL LID UNLOCK OUTPUT
11	GR	BAT (FALSE)
13	B	GND

14	W	PUSH-BUTTON IGNITION SW ILL GND
15	BG	ACC IND
17	BR	TURN SIGNAL RH (FRONT)
18	BG	TURN SIGNAL LH (FRONT)
19	V	ROOM LAMP-TIMER CONTROL

Connector No.	M121
Connector Name	BCM (BODY CONTROL MODULE)
Connector Type	TH40FGY-NH



Terminal No.	Color of Wire	Signal Name [Specification]
34	SB	TRUNK ROOM ANT-
35	V	TRUNK ROOM ANT+
38	B	REAR BUMPER ANT-
39	W	REAR BUMPER ANT+
47	Y	IGN RELAY (EDM E/R) CONT
50	G	TRUNK ROOM LAMP SW
52	BR	STARTER RELAY CONT
60	BR	PUSH SW
61	SB	TRUNK LID OPENER REQUEST SW
64	G	I-KEY WARN BUZZER (ENG ROOM)
67	GR	TRUNK LID OPENER SW

Connector No.	M122
Connector Name	BCM (BODY CONTROL MODULE)
Connector Type	TH40FB-NH



Terminal No.	Color of Wire	Signal Name [Specification]
72	R	ROOM ANT 2-
73	G	ROOM ANT 2+
74	SB	PASSENGER DOOR ANT-
75	BR	PASSENGER DOOR ANT+

76	V	DRIVER DOOR ANT-
77	LG	DRIVER DOOR ANT+
78	Y	ROOM ANT 1-
79	BR	ROOM ANT 1+
80	GR	MATS ANTENNA AMP-
81	W	MATS ANTENNA AMP+
82	R	IGN RELAY (F/B) CONT
83	Y	KEYLESS ENTRY RECEIVER COMM
88	BG	COMBI SW INPUT 5
89	BR	COMBI SW INPUT 3
89	BR	PUSH SW
90	P	GAN-L
91	L	GAN-H
92	LG	KEY SLOT ILL
93	V	ON IND
95	BG	ACC RELAY CONT
96	GR	A/T SHIFT SELECTOR POWER SUPPLY
97	L	S/L CONDITION 1
98	SB	S/L CONDITION 2
99	R	ASCD CLUTCH SW (R/H, M/T)
99	R	SHIFT P (R/H, A/T)
100	Y	PASSENGER DOOR REQUEST SW
101	P	DRIVER DOOR REQUEST SW
102	BG	BLOWER FAN MOTOR RELAY CONT
103	LG	KEYLESS ENTRY RECEIVER POWER SUPPLY
106	W	S/L UNIT POWER SUPPLY
107	LG	COMBI SW INPUT 1
108	R	COMBI SW INPUT 4
109	W	COMBI SW INPUT 2
110	G	HAZARD SW
111	Y	S/L UNIT COMM

VEHICLE SECURITY SYSTEM

< DTC/CIRCUIT DIAGNOSIS >

VEHICLE SECURITY SYSTEM

Connector No.	M123
Connector Name	BCM (BODY CONTROL MODULE)
Connector Type	TH40FG-1M



Terminal No.	Color of Wire	Signal Name [Specification]
112	BR	RAIN SENSOR SERIAL LINK
113	G	OPTICAL SENSOR
114	R	CLUTCH INTERLOCK SW
116	SB	STOP LAMP SW 1
118	BR	STOP LAMP SW 2
119	GR	DR DOOR UNLOCK SENSOR
121	SB	KEY SLOT SW
123	W	IGN P/B
124	BG	PASSENGER DOOR SW
129	BG	TRUNK LID OPENER CANCEL SW
132	LG	P/W SW & RRH C/U COMM
133	Y	PUSH-BUTTON IGNITION SW ILL POWER
134	LG	LOCK IND
137	BG	RECEIVER / SENSOR GND
138	Y	RECEIVER / SENSOR POWER SUPPLY
139	L	TIRE PRESSURE RECEIVER COMM
140	GR	SHIFT N/P
141	R	SECURITY INDICATOR LAMP
142	BR	COMBI SW OUTPUT 5
143	V	COMBI SW OUTPUT 1
144	G	COMBI SW OUTPUT 2
145	L	COMBI SW OUTPUT 3
146	SB	COMBI SW OUTPUT 4
150	R	DRIVER DOOR SW
151	G	REAR WINDOW DEFOGGER RELAY CONT

JCKWM5265GB

A
B
C
D
E
F
G
H
I
J
L
M
N
O
P

SEC

BCM (BODY CONTROL MODULE)

< ECU DIAGNOSIS INFORMATION >

ECU DIAGNOSIS INFORMATION

BCM (BODY CONTROL MODULE)

Reference Value

INFOID:000000006956338

VALUES ON THE DIAGNOSIS TOOL

CONSULT-III MONITOR ITEM

Monitor Item	Condition	Value/Status
FR WIPER HI	Other than front wiper switch HI	Off
	Front wiper switch HI	On
FR WIPER LOW	Other than front wiper switch LO	Off
	Front wiper switch LO	On
FR WASHER SW	Front washer switch OFF	Off
	Front washer switch ON	On
FR WIPER INT	Other than front wiper switch INT/AUTO	Off
	Front wiper switch INT/AUTO	On
FR WIPER STOP	Front wiper is not in STOP position	Off
	Front wiper is in STOP position	On
INT VOLUME	Wiper volume dial is in a dial position 1 - 7	Wiper volume dial position
TURN SIGNAL R	Other than turn signal switch RH	Off
	Turn signal switch RH	On
TURN SIGNAL L	Other than turn signal switch LH	Off
	Turn signal switch LH	On
TAIL LAMP SW	Other than lighting switch 1ST and 2ND	Off
	Lighting switch 1ST or 2ND	On
HI BEAM SW	Other than lighting switch HI	Off
	Lighting switch HI	On
HEAD LAMP SW 1	Other than lighting switch 2ND	Off
	Lighting switch 2ND	On
HEAD LAMP SW 2	Other than lighting switch 2ND	Off
	Lighting switch 2ND	On
PASSING SW	Other than lighting switch PASS	Off
	Lighting switch PASS	On
AUTO LIGHT SW	Other than lighting switch AUTO	Off
	Lighting switch AUTO	On
FR FOG SW	Front fog lamp switch OFF	Off
	Front fog lamp switch ON	On
RR FOG SW	NOTE: The item is indicated, but not monitored.	Off
DOOR SW-DR	Driver door closed	Off
	Driver door opened	On
DOOR SW-AS	Passenger door closed	Off
	Passenger door opened	On
DOOR SW-RR	NOTE: The item is indicated, but not monitored.	Off

BCM (BODY CONTROL MODULE)

< ECU DIAGNOSIS INFORMATION >

Monitor Item	Condition	Value/Status	
DOOR SW-RL	NOTE: The item is indicated, but not monitored.	Off	A
DOOR SW-BK	NOTE: The item is indicated, but not monitored.	Off	B
CDL LOCK SW	Other than power door lock switch LOCK	Off	C
	Power door lock switch LOCK	On	
CDL UNLOCK SW	Other than power door lock switch UNLOCK	Off	D
	Power door lock switch UNLOCK	On	
KEY CYL LK-SW	Other than driver door key cylinder LOCK position	Off	E
	Driver door key cylinder LOCK position	On	
KEY CYL UN-SW	Other than driver door key cylinder UNLOCK position	Off	F
	Driver door key cylinder UNLOCK position	On	
KEY CYL SW-TR	NOTE: The item is indicated, but not monitored.	Off	G
HAZARD SW	Hazard switch is OFF	Off	H
	Hazard switch is ON	On	
REAR DEF SW	NOTE: The item is indicated, but not monitored.	Off	I
H/L WASH SW	NOTE: The item is indicated, but not monitored.	Off	J
TR CANCEL SW	Trunk lid opener cancel switch OFF	Off	K
	Trunk lid opener cancel switch ON	On	
TR/BD OPEN SW	Trunk lid opener switch OFF	Off	L
	While the trunk lid opener switch is turned ON	On	
TRNK/HAT MNTR	Trunk lid closed	Off	M
	Trunk lid opened	On	
RKE-LOCK	LOCK button of the Intelligent Key is not pressed	Off	N
	LOCK button of the Intelligent Key is pressed	On	
RKE-UNLOCK	UNLOCK button of the Intelligent Key is not pressed	Off	O
	UNLOCK button of the Intelligent Key is pressed	On	
RKE-TR/BD	TRUNK OPEN button of the Intelligent Key is not pressed	Off	P
	TRUNK OPEN button of the Intelligent Key is pressed	On	
RKE-PANIC	PANIC button of the Intelligent Key is not pressed	Off	P
	PANIC button of the Intelligent Key is pressed	On	
RKE-P/W OPEN	UNLOCK button of the Intelligent Key is not pressed	Off	P
	UNLOCK button of the Intelligent Key is pressed and held	On	
RKE-MODE CHG	LOCK/UNLOCK button of the Intelligent Key is not pressed and held simultaneously	Off	P
	LOCK/UNLOCK button of the Intelligent Key is pressed and held simultaneously	On	
OPTICAL SENSOR	Bright outside of the vehicle	Close to 5 V	P
	Dark outside of the vehicle	Close to 0 V	
REQ SW -DR	Driver door request switch is not pressed	Off	P
	Driver door request switch is pressed	On	
REQ SW -AS	Passenger door request switch is not pressed	Off	P
	Passenger door request switch is pressed	On	
REQ SW -RR	NOTE: The item is indicated, but not monitored.	Off	P

SEC

BCM (BODY CONTROL MODULE)

< ECU DIAGNOSIS INFORMATION >

Monitor Item	Condition	Value/Status
REQ SW -RL	NOTE: The item is indicated, but not monitored.	Off
REQ SW -BD/TR	Trunk lid opener request switch is not pressed	Off
	Trunk lid opener request switch is pressed	On
PUSH SW	Push-button ignition switch (push switch) is not pressed	Off
	Push-button ignition switch (push switch) is pressed	On
IGN RLY2 -F/B	Ignition switch in OFF or ACC position	Off
	Ignition switch in ON position	On
ACC RLY -F/B	NOTE: The item is indicated, but not monitored.	Off
CLUCH SW	The clutch pedal is not depressed	Off
	The clutch pedal is depressed	On
BRAKE SW 1	The brake pedal is depressed when No. 7 fuse is blown	Off
	The brake pedal is not depressed when No. 7 fuse is blown, or No. 7 fuse is normal	On
BRAKE SW 2	The brake pedal is not depressed	Off
	The brake pedal is depressed	On
DETE/CANCL SW	<ul style="list-style-type: none"> • Selector lever in P position (Except M/T models) • The clutch pedal is depressed (M/T models) 	Off
	<ul style="list-style-type: none"> • Selector lever in any position other than P (Except M/T models) • The clutch pedal is not depressed (M/T models) 	On
SFT PN/N SW	Selector lever in any position other than P and N	Off
	Selector lever in P or N position	On
S/L -LOCK NOTE: For models without steering lock unit, this item is not monitored.	Steering is unlocked	Off
	Steering is locked	On
S/L -UNLOCK NOTE: For models without steering lock unit, this item is not monitored.	Steering is locked	Off
	Steering is unlocked	On
S/L RELAY-F/B NOTE: For models without steering lock unit, this item is not monitored.	Ignition switch in OFF or ACC position	Off
	Ignition switch in ON position	On
UNLK SEN -DR	Driver door is unlocked	Off
	Driver door is locked	On
PUSH SW -IPDM	Push-button ignition switch (push-switch) is not pressed	Off
	Push-button ignition switch (push-switch) is pressed	On
IGN RLY1 -F/B	Ignition switch in OFF or ACC position	Off
	Ignition switch in ON position	On
DETE SW -IPDM	Selector lever in any position other than P	Off
	Selector lever in P position	On
SFT PN -IPDM	<ul style="list-style-type: none"> • Selector lever in any position other than P and N (Except M/T models) • The clutch pedal is not depressed (M/T models) 	Off
	<ul style="list-style-type: none"> • Selector lever in P or N position • The clutch pedal is depressed 	On

BCM (BODY CONTROL MODULE)

< ECU DIAGNOSIS INFORMATION >

Monitor Item	Condition	Value/Status	
SFT P -MET	Selector lever in any position other than P	Off	A
	Selector lever in P position	On	
SFT N -MET	Selector lever in any position other than N	Off	B
	Selector lever in N position	On	
ENGINE STATE	Engine stopped	Stop	
	While the engine stalls	Stall	C
	At engine cranking	Crank	
	Engine running	Run	D
S/L LOCK-IPDM NOTE: For models without steering lock unit, this item is not monitored.	Steering is unlocked	Off	E
	Steering is locked	On	
S/L UNLK-IPDM NOTE: For models without steering lock unit, this item is not monitored.	Steering is locked	Off	F
	Steering is unlocked	On	
S/L RELAY-REQ NOTE: For models without steering lock unit, this item is not monitored.	Steering lock system is not the LOCK condition and the changing condition from LOCK to UNLOCK	Off	G
	Steering lock system are not the LOCK condition or the changing condition from LOCK to UNLOCK	On	H
VEH SPEED 1	While driving	Equivalent to speedometer reading	I
VEH SPEED 2	While driving	Equivalent to speedometer reading	
DOOR STAT-DR	Driver door is locked	LOCK	J
	Wait with selective UNLOCK operation (60 seconds)	READY	
	Driver door is unlocked	UNLOCK	
DOOR STAT-AS	Passenger door is locked	LOCK	SEC
	Wait with selective UNLOCK operation (60 seconds)	READY	
	Passenger door is unlocked	UNLOCK	L
ID OK FLAG	Driver side door is open after ignition switch is turned OFF (Selector lever is in the P position except for M/T models)	Reset	
	Ignition switch ON	Set	M
PRMT ENG STRT	The engine start is prohibited	Reset	
	The engine start is permitted	Set	
PRMT RKE STRT	NOTE: The item is indicated, but not monitored.	Reset	N
KEY SW -SLOT	The Intelligent Key is not inserted into key slot	Off	O
	The Intelligent Key is inserted into key slot	On	
RKE OPE COUN1	During the operation of the Intelligent Key	Operation frequency of the Intelligent Key	P
RKE OPE COUN2	NOTE: The item is indicated, but not monitored.	—	
CONFRM ID ALL	The key ID that the key slot receives is not recognized by any key ID registered to BCM.	Yet	
	The key ID that the key slot receives is recognized by any key ID registered to BCM.	Done	

BCM (BODY CONTROL MODULE)

< ECU DIAGNOSIS INFORMATION >

Monitor Item	Condition	Value/Status
CONFIRM ID4	The key ID that the key slot receives is not recognized by the fourth key ID registered to BCM.	Yet
	The key ID that the key slot receives is recognized by the fourth key ID registered to BCM.	Done
CONFIRM ID3	The key ID that the key slot receives is not recognized by the third key ID registered to BCM.	Yet
	The key ID that the key slot receives is recognized by the third key ID registered to BCM.	Done
CONFIRM ID2	The key ID that the key slot receives is not recognized by the second key ID registered to BCM.	Yet
	The key ID that the key slot receives is recognized by the second key ID registered to BCM.	Done
CONFIRM ID1	The key ID that the key slot receives is not recognized by the first key ID registered to BCM.	Yet
	The key ID that the key slot receives is recognized by the first key ID registered to BCM.	Done
TP 4	The ID of fourth Intelligent Key is not registered to BCM	Yet
	The ID of fourth Intelligent Key is registered to BCM	Done
TP 3	The ID of third Intelligent Key is not registered to BCM	Yet
	The ID of third Intelligent Key is registered to BCM	Done
TP 2	The ID of second Intelligent Key is not registered to BCM	Yet
	The ID of second Intelligent Key is registered to BCM	Done
TP 1	The ID of first Intelligent Key is not registered to BCM	Yet
	The ID of first Intelligent Key is registered to BCM	Done
AIR PRESS FL	Ignition switch ON (Only when the signal from the transmitter is received)	Air pressure of front LH tire
AIR PRESS FR	Ignition switch ON (Only when the signal from the transmitter is received)	Air pressure of front RH tire
AIR PRESS RR	Ignition switch ON (Only when the signal from the transmitter is received)	Air pressure of rear RH tire
AIR PRESS RL	Ignition switch ON (Only when the signal from the transmitter is received)	Air pressure of rear LH tire
ID REGST FL1	ID of front LH tire transmitter is registered	Done
	ID of front LH tire transmitter is not registered	Yet
ID REGST FR1	ID of front RH tire transmitter is registered	Done
	ID of front RH tire transmitter is not registered	Yet
ID REGST RR1	ID of rear RH tire transmitter is registered	Done
	ID of rear RH tire transmitter is not registered	Yet
ID REGST RL1	ID of rear LH tire transmitter is registered	Done
	ID of rear LH tire transmitter is not registered	Yet
WARNING LAMP	Tire pressure indicator OFF	Off
	Tire pressure indicator ON	On
BUZZER	Tire pressure warning alarm is not sounding	Off
	Tire pressure warning alarm is sounding	On

BCM (BODY CONTROL MODULE)

< ECU DIAGNOSIS INFORMATION >

TERMINAL LAYOUT

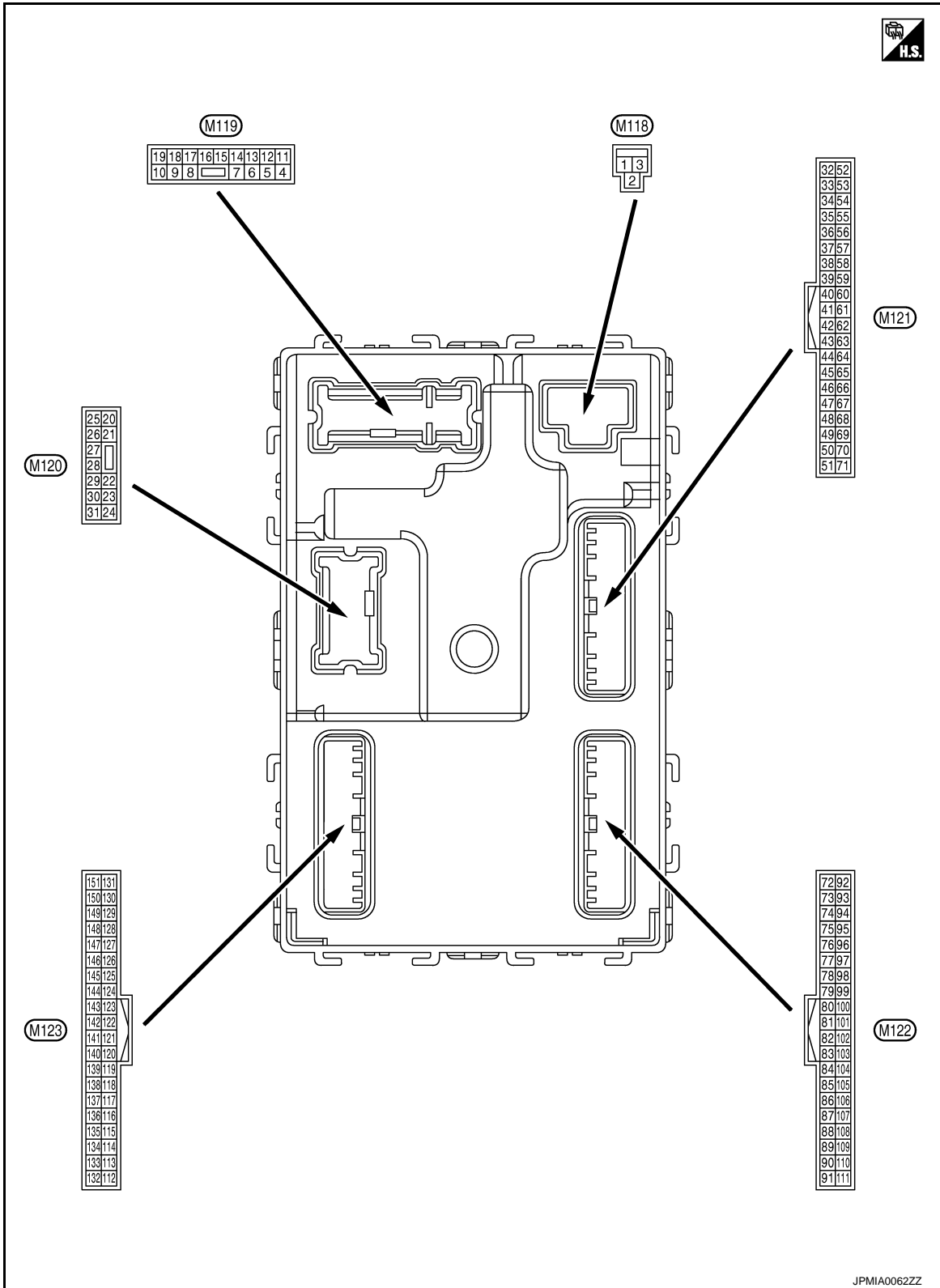

PHYSICAL VALUES

A
B
C
D
E
F
G
H
I
J
K
L
M
N
O
P

SEC

BCM (BODY CONTROL MODULE)

< ECU DIAGNOSIS INFORMATION >

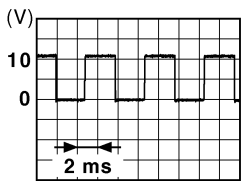
Terminal No. (Wire color)		Description		Condition		Value (Approx.)
		Signal name	Input/ Output			
+	-					
1 (W)	Ground	Battery power supply	Input	Ignition switch OFF		Battery voltage
2 (Y)	Ground	P/W power supply (BAT)	Output	Ignition switch OFF		12 V
3 (BG)	Ground	P/W power supply (RAP)	Output	Ignition switch ON		12 V
4 (LG)	Ground	Interior room lamp power supply	Output	Interior room lamp battery saver is activated. (Cuts the interior room lamp power supply)		0 V
				Interior room lamp battery saver is not activated. (Outputs the interior room lamp power supply)		12 V
5 (P)	Ground	Passenger door UN- LOCK	Output	Passenger door	UNLOCK (Actuator is activated)	12 V
					Other than UNLOCK (Actuator is not activated)	0 V
7 (SB)	Ground	Step lamp	Output	Step lamp	ON	0 V
					OFF	12 V
8 (V)	Ground	All doors, fuel lid LOCK	Output	All doors, fuel lid	LOCK (Actuator is activated)	12 V
					Other than LOCK (Actuator is not activated)	0 V
9 (G)	Ground	Driver door, fuel lid UNLOCK	Output	Driver door, fuel lid	UNLOCK (Actuator is activated)	12 V
					Other than UNLOCK (Actuator is not activated)	0 V
11 (GR)	Ground	Battery power supply	Input	Ignition switch OFF		Battery voltage
13 (B)	Ground	Ground	—	Ignition switch ON		0 V
14 (W)	Ground	Push-button ignition switch illumination ground	Output	Tail lamp	OFF	0 V
					ON	<p style="text-align: center;">NOTE: When the illumination brightening/dimming level is in the neutral position.</p>  <p style="text-align: right; font-size: small;">JSNIA0010GB</p>
15 (BG)	Ground	ACC indicator lamp	Output	Ignition switch	OFF (LOCK indicator is not illuminated)	Battery voltage
					ACC	0 V

BCM (BODY CONTROL MODULE)

< ECU DIAGNOSIS INFORMATION >

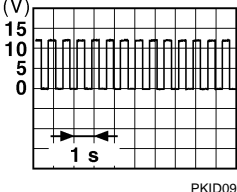
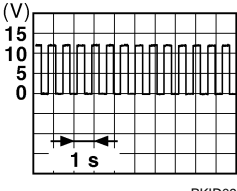
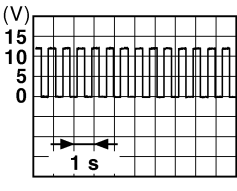
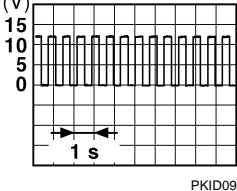
Terminal No. (Wire color)		Description		Condition	Value (Approx.)	
		Signal name	Input/ Output			
+	-					
17 (BR)	Ground	Turn signal RH (Front)	Output	Ignition switch ON	Turn signal switch OFF	0 V
					Turn signal switch RH	 6.5 V
18 (BG)	Ground	Turn signal LH (Front)	Output	Ignition switch ON	Turn signal switch OFF	0 V
					Turn signal switch LH	 6.5 V
19 (V)	Ground	Room lamp timer control	Output	Interior room lamp	OFF	12 V
					ON	0 V
20 (V)	Ground	Turn signal RH (Rear)	Output	Ignition switch ON	Turn signal switch OFF	0 V
					Turn signal switch RH	 6.5 V
23 (Y)	Ground	Trunk lid open	Output	Trunk lid	OPEN (Trunk lid opener actuator is activated)	12 V
					Other than OPEN (Trunk lid opener actuator is not activated)	0 V
25 (Y)	Ground	Turn signal LH (Rear)	Output	Ignition switch ON	Turn signal switch OFF	0 V
					Turn signal switch LH	 6.5 V
30 (P)	Ground	Trunk room lamp	Output	Trunk room lamp	ON	0 V
					OFF	12 V

A
B
C
D
E
F
G
H
I
J
L
M
N
O
P

SEC

BCM (BODY CONTROL MODULE)

< ECU DIAGNOSIS INFORMATION >

Terminal No. (Wire color)		Description		Condition	Value (Approx.)
+	-	Signal name	Input/ Output		
34 (SB)	Ground	Trunk room antenna (-)	Output	Ignition switch OFF	<p style="text-align: right; font-size: small;">JMKIA0062GB</p>
				When Intelligent Key is not in the passenger compart- ment	<p style="text-align: right; font-size: small;">JMKIA0063GB</p>
35 (V)	Ground	Trunk room antenna (+)	Output	Ignition switch OFF	<p style="text-align: right; font-size: small;">JMKIA0062GB</p>
				When Intelligent Key is not in the passenger compart- ment	<p style="text-align: right; font-size: small;">JMKIA0063GB</p>
38 (B)	Ground	Rear bumper anten- na (-)	Output	When the trunk lid opener re- quest switch is operated with ignition switch OFF	<p style="text-align: right; font-size: small;">JMKIA0062GB</p>
				When Intelligent Key is not in the antenna detection area	<p style="text-align: right; font-size: small;">JMKIA0063GB</p>

BCM (BODY CONTROL MODULE)

< ECU DIAGNOSIS INFORMATION >

Terminal No. (Wire color)		Description		Condition	Value (Approx.)	
+	-	Signal name	Input/ Output			
39 (W)	Ground	Rear bumper antenna (+)	Output	When Intelligent Key is in the antenna detection area	<p style="text-align: right; font-size: small;">JMKIA0062GB</p>	
				When the trunk lid opener request switch is operated with ignition switch OFF	<p style="text-align: right; font-size: small;">JMKIA0063GB</p>	
47 (Y)	Ground	Ignition relay (IPDM E/R) control	Output	Ignition switch	OFF or ACC	12 V
				ON	0 V	
50 (G)	Ground	Trunk room lamp switch	Input	Trunk room lamp switch	OFF (Trunk lid is closed)	<p style="text-align: right; font-size: small;">JPMIA0011GB</p>
					ON (Trunk lid is opened)	0 V
52 (BR)	Ground	Starter relay control	Output	Ignition switch ON (A/T models)	When selector lever is in P or N position	12 V
				Ignition switch ON (M/T models)	When selector lever is not in P or N position	0 V
			Input	Push-button ignition switch (push switch)	Pressed	0 V
				Not pressed	Battery voltage	
61 (SB)	Ground	Trunk lid opener request switch	Input	Trunk lid opener request switch	ON (Pressed)	0 V
				OFF (Not pressed)	<p style="text-align: right; font-size: small;">JPMIA0016GB</p>	
64 (G)	Ground	Intelligent Key warning buzzer (Engine room)	Output	Intelligent Key warning buzzer (Engine room)	Sounding	0 V
				Not sounding	12 V	

A
B
C
D
E
F
G
H
I
J
L
M
N
O
P

SEC

BCM (BODY CONTROL MODULE)

< ECU DIAGNOSIS INFORMATION >

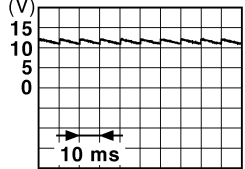
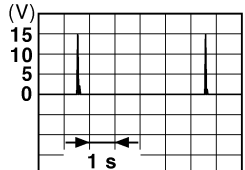
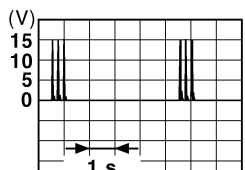
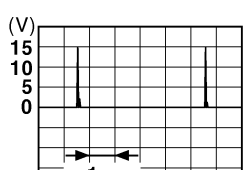
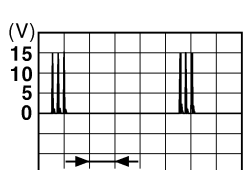
Terminal No. (Wire color)		Description		Condition	Value (Approx.)	
+	-	Signal name	Input/ Output			
67 (GR)	Ground	Trunk lid opener switch	Input	Trunk lid open- er switch	Pressed	0 V
					Not pressed	 <p style="text-align: right; font-size: small;">JPMIA0011GB</p>
72 (R)	Ground	Room antenna 2 (-) (Center console)	Output	Ignition switch OFF	When Intelligent Key is in the passenger compart- ment	 <p style="text-align: right; font-size: small;">JMKIA0062GB</p>
					When Intelligent Key is not in the passenger compart- ment	 <p style="text-align: right; font-size: small;">JMKIA0063GB</p>
73 (G)	Ground	Room antenna 2 (+) (Center console)	Output	Ignition switch OFF	When Intelligent Key is in the passenger compart- ment	 <p style="text-align: right; font-size: small;">JMKIA0062GB</p>
					When Intelligent Key is not in the passenger compart- ment	 <p style="text-align: right; font-size: small;">JMKIA0063GB</p>

BCM (BODY CONTROL MODULE)

< ECU DIAGNOSIS INFORMATION >

Terminal No. (Wire color)		Description		Condition	Value (Approx.)
+	-	Signal name	Input/ Output		
74 (SB)	Ground	Passenger door antenna (-)	Output	When Intelligent Key is in the antenna detection area	<p style="text-align: right; font-size: small;">JMkia0062GB</p>
				When the passenger door request switch is operated with ignition switch OFF	<p style="text-align: right; font-size: small;">JMkia0063GB</p>
75 (BR)	Ground	Passenger door antenna (+)	Output	When Intelligent Key is in the antenna detection area	<p style="text-align: right; font-size: small;">JMkia0062GB</p>
				When the passenger door request switch is operated with ignition switch OFF	<p style="text-align: right; font-size: small;">JMkia0063GB</p>
76 (V)	Ground	Driver door antenna (-)	Output	When Intelligent Key is in the antenna detection area	<p style="text-align: right; font-size: small;">JMkia0062GB</p>
				When the driver door request switch is operated with ignition switch OFF	<p style="text-align: right; font-size: small;">JMkia0063GB</p>

A
B
C
D
E
F
G
H
I
J
L
M
N
O
P

SEC

BCM (BODY CONTROL MODULE)

< ECU DIAGNOSIS INFORMATION >

Terminal No. (Wire color)		Description		Condition	Value (Approx.)
+	-	Signal name	Input/ Output		
77 (LG)	Ground	Driver door antenna (+)	Output	When Intelligent Key is in the antenna detection area	<p style="text-align: right; font-size: small;">JMKIA0062GB</p>
				When the driver door request switch is oper- ated with igni- tion switch OFF	When Intelligent Key is not in the antenna detection area
78 (Y)	Ground	Room antenna 1 (-) (Instrument panel)	Output	When Intelligent Key is in the passenger compart- ment	<p style="text-align: right; font-size: small;">JMKIA0062GB</p>
				Ignition switch OFF	When Intelligent Key is not in the passenger compart- ment
79 (BR)	Ground	Room antenna 1 (+) (Instrument panel)	Output	When Intelligent Key is in the passenger compart- ment	<p style="text-align: right; font-size: small;">JMKIA0062GB</p>
				Ignition switch OFF	When Intelligent Key is not in the passenger compart- ment

BCM (BODY CONTROL MODULE)

< ECU DIAGNOSIS INFORMATION >

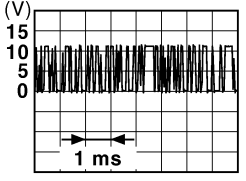
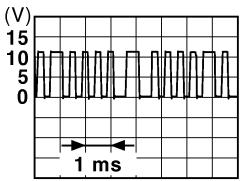
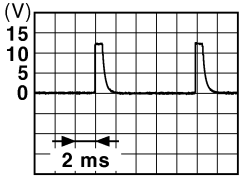
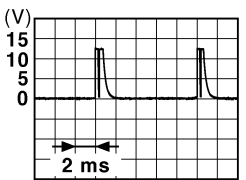
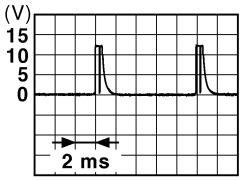
Terminal No. (Wire color)		Description		Condition		Value (Approx.)
+	-	Signal name	Input/ Output			
80 (GR)	Ground	NATS antenna amp.	Input/ Output	During waiting	Ignition switch is pressed while inserting the Intelligent Key into the key slot.	Just after pressing ignition switch. Pointer of tester should move.
81 (W)	Ground	NATS antenna amp.	Input/ Output	During waiting	Ignition switch is pressed while inserting the Intelligent Key into the key slot.	Just after pressing ignition switch. Pointer of tester should move.
82 (R)	Ground	Ignition relay [Fuse block (J/B)] control	Output	Ignition switch	OFF or ACC ON	0 V 12 V
83 (Y)	Ground	Remote keyless entry receiver communication	Input/ Output	During waiting		 <p style="text-align: right; font-size: small;">JMKIA0064GB</p>
				When operating either button on the Intelligent Key		 <p style="text-align: right; font-size: small;">JMKIA0065GB</p>
87 (Y)	Ground	Combination switch INPUT 5	Input	Combination switch	All switches OFF (Wiper volume dial 4)	 <p style="text-align: right; font-size: small;">JPMIA0041GB</p> <p style="text-align: center;">1.4 V</p>
					Front fog lamp switch ON (Wiper volume dial 4)	 <p style="text-align: right; font-size: small;">JPMIA0037GB</p> <p style="text-align: center;">1.3 V</p>
					Any of the conditions below with all switches OFF <ul style="list-style-type: none"> • Wiper volume dial 1 • Wiper volume dial 2 • Wiper volume dial 6 • Wiper volume dial 7 	 <p style="text-align: right; font-size: small;">JPMIA0040GB</p> <p style="text-align: center;">1.3 V</p>

A
B
C
D
E
F
G
H
I
J
L
M
N
O
P

SEC

BCM (BODY CONTROL MODULE)

< ECU DIAGNOSIS INFORMATION >

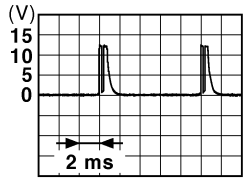
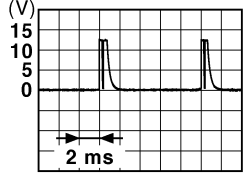
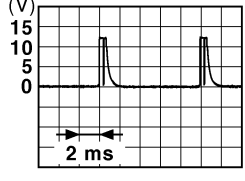
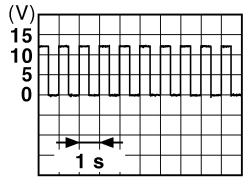
Terminal No. (Wire color)		Description		Condition	Value (Approx.)	
+	-	Signal name	Input/ Output			
88 (BG)	Ground	Combination switch INPUT 3	Input	Combination switch	All switches OFF (Wiper volume dial 4)	 <p style="text-align: right; font-size: small;">JPMAI0041GB</p> <p style="text-align: center;">1.4 V</p>
					Lighting switch HI (Wiper volume dial 4)	 <p style="text-align: right; font-size: small;">JPMAI0036GB</p> <p style="text-align: center;">1.3 V</p>
					Lighting switch 2ND (Wiper volume dial 4)	 <p style="text-align: right; font-size: small;">JPMAI0037GB</p> <p style="text-align: center;">1.3 V</p>
					Any of the conditions below with all switches OFF <ul style="list-style-type: none"> • Wiper volume dial 1 • Wiper volume dial 2 • Wiper volume dial 3 	 <p style="text-align: right; font-size: small;">JPMAI0040GB</p> <p style="text-align: center;">1.3 V</p>
89*2 (BR)	Ground	Push-button ignition switch (Push switch)	Input	Push-button ignition switch (push switch)	Pressed	0 V
					Not pressed	Battery voltage
90 (P)	Ground	CAN-L	Input/ Output	—	—	
91 (L)	Ground	CAN-H	Input/ Output	—	—	
92 (LG)	Ground	Key slot illumination	Output	Key slot illumina- tion	OFF	0 V
					Blinking	 <p style="text-align: right; font-size: small;">JPMAI0015GB</p> <p style="text-align: center;">6.5 V</p>
					ON	12 V

BCM (BODY CONTROL MODULE)

< ECU DIAGNOSIS INFORMATION >

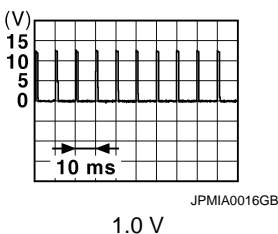
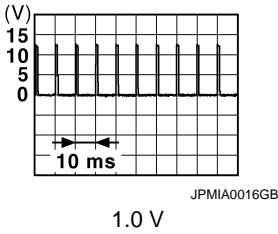



Terminal No. (Wire color)		Description		Condition		Value (Approx.)
		Signal name	Input/ Output			
+	-					
93 (V)	Ground	ON indicator lamp	Output	Ignition switch	OFF (LOCK indicator is not illuminated)	Battery voltage
					ON	0 V
95 (BG)	Ground	ACC relay control	Output	Ignition switch	OFF	0 V
					ACC or ON	12 V
96 (GR)	Ground	A/T shift selector (Detention switch) power supply	Output	—		12 V
97*2 (L)	Ground	Steering lock condition No. 1	Input	Steering lock	LOCK status	0 V
					UNLOCK status	12 V
98*2 (SB)	Ground	Steering lock condition No. 2	Input	Steering lock	LOCK status	12 V
					UNLOCK status	0 V
99 (R)	Ground	Selector lever P position switch	Input	Selector lever	P position	0 V
					Any position other than P	12 V
		ASCD clutch switch (M/T models without ICC)		ASCD clutch switch	OFF (Clutch pedal is depressed)	0 V
					ON (Clutch pedal is not depressed)	12 V
		ICC clutch switch (M/T models with ICC)		ICC clutch switch	OFF (Clutch pedal is depressed)	0 V
					ON (Clutch pedal is not depressed)	12 V
100 (Y)	Ground	Passenger door request switch	Input	Passenger door request switch	ON (Pressed)	0 V
					OFF (Not pressed)	
101 (P)	Ground	Driver door request switch	Input	Driver door request switch	ON (Pressed)	0 V
					OFF (Not pressed)	
102 (BG)	Ground	Blower fan motor relay control	Output	Ignition switch	OFF or ACC	0 V
					ON	12 V
103 (LG)	Ground	Remote keyless entry receiver power supply	Output	Ignition switch OFF		12 V
106*2 (W)	Ground	Steering lock unit power supply	Output	Ignition switch	OFF or ACC	12 V
					ON	0 V

A
B
C
D
E
F
G
H
I
J
L
M
N
O
P

SEC

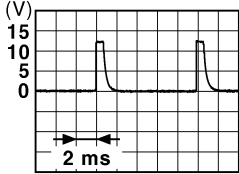

BCM (BODY CONTROL MODULE)

< ECU DIAGNOSIS INFORMATION >

Terminal No. (Wire color)		Description		Condition	Value (Approx.)	
		Signal name	Input/ Output			
+	-					
107 (LG)	Ground	Combination switch INPUT 1	Input	Combination switch (Wiper volume dial 4)	All switches OFF	 <p style="text-align: right;">1.4 V</p>
					Turn signal switch LH	 <p style="text-align: right;">1.3 V</p>
					Turn signal switch RH	 <p style="text-align: right;">1.3 V</p>
					Front wiper switch LO	 <p style="text-align: right;">1.3 V</p>
					Front washer switch ON	 <p style="text-align: right;">1.3 V</p>

BCM (BODY CONTROL MODULE)

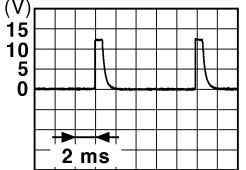
< ECU DIAGNOSIS INFORMATION >

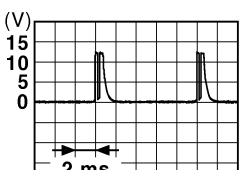
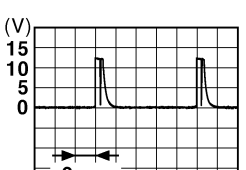
Terminal No. (Wire color)		Description		Condition	Value (Approx.)	
		Signal name	Input/ Output			
+	-					
108 (R)	Ground	Combination switch INPUT 4	Input	Combination switch	All switches OFF (Wiper volume dial 4)	 <p style="text-align: right; font-size: small;">JPMIA0041GB</p> <p style="text-align: center;">1.4 V</p>
					Lighting switch AUTO (Wiper volume dial 4)	 <p style="text-align: right; font-size: small;">JPMIA0038GB</p> <p style="text-align: center;">1.3 V</p>
					Lighting switch 1ST (Wiper volume dial 4)	 <p style="text-align: right; font-size: small;">JPMIA0036GB</p> <p style="text-align: center;">1.3 V</p>
					Any of the conditions below with all switches OFF <ul style="list-style-type: none"> • Wiper volume dial 1 • Wiper volume dial 5 • Wiper volume dial 6 	 <p style="text-align: right; font-size: small;">JPMIA0039GB</p> <p style="text-align: center;">1.3 V</p>

A
B
C
D
E
F
G
H
I
J
L
M
N
O
P

SEC

BCM (BODY CONTROL MODULE)

< ECU DIAGNOSIS INFORMATION >

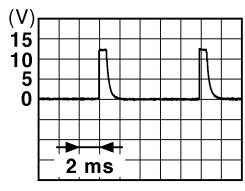
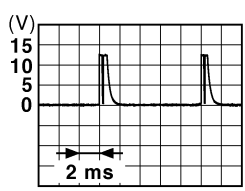
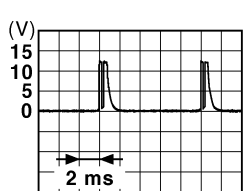
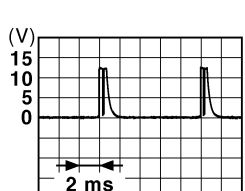
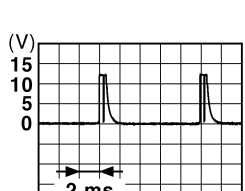
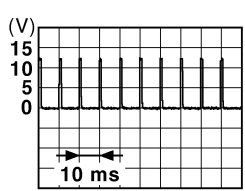
Terminal No. (Wire color)		Description		Condition	Value (Approx.)	
+	-	Signal name	Input/ Output			
109 (W)	Ground	Combination switch INPUT 2	Input	Combination switch (Wiper volume dial 4)	All switches OFF	 <p style="text-align: right; font-size: small;">JPMA0041GB</p> <p style="text-align: center;">1.4 V</p>
					Lighting switch PASS	 <p style="text-align: right; font-size: small;">JPMA0037GB</p> <p style="text-align: center;">1.3 V</p>
					Lighting switch 2ND	 <p style="text-align: right; font-size: small;">JPMA0036GB</p> <p style="text-align: center;">1.3 V</p>
					Front wiper switch INT/ AUTO	 <p style="text-align: right; font-size: small;">JPMA0038GB</p> <p style="text-align: center;">1.3 V</p>
					Front wiper switch HI	 <p style="text-align: right; font-size: small;">JPMA0040GB</p> <p style="text-align: center;">1.3 V</p>
110 (G)	Ground	Hazard switch	Input	Hazard switch	ON	0 V
				Hazard switch	OFF	 <p style="text-align: right; font-size: small;">JPMA0012GB</p> <p style="text-align: center;">1.1 V</p>

BCM (BODY CONTROL MODULE)

< ECU DIAGNOSIS INFORMATION >

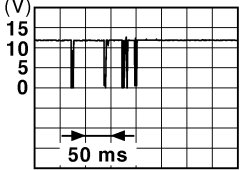
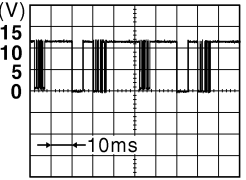
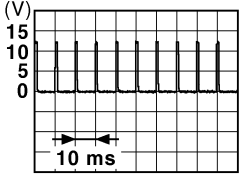
Terminal No. (Wire color)		Description		Condition	Value (Approx.)	
+	-	Signal name	Input/ Output			
111*2 (Y)	Ground	Steering lock unit communication	Input/ Output	Steering lock	LOCK status	12 V
					LOCK or UNLOCK	 <p style="text-align: right; font-size: small;">JMKIA0066GB</p>
					For 15 seconds after UN- LOCK	12 V
				15 seconds or later after UNLOCK	0 V	
112 (BR)	Ground	Rain sensor serial link	Input/ Output	Ignition switch ON	 <p style="text-align: right; font-size: small;">JPMIA0156GB</p>	
					8.7 V	
113 (G)	Ground	Optical sensor	Input	Ignition switch ON	When bright outside of the vehicle	Close to 5 V
				When dark outside of the vehicle	Close to 0 V	
114 (R)	Ground	Clutch interlock switch	Input	Clutch interlock switch	OFF (Clutch pedal is not depressed)	0 V
					ON (Clutch pedal is de- pressed)	Battery voltage
116 (SB)	Ground	Stop lamp switch 1	Input	—	Battery voltage	
118 (BR)	Ground	Stop lamp switch 2 (Without ICC)	Input	Stop lamp switch	OFF (Brake pedal is not depressed)	0 V
					ON (Brake pedal is de- pressed)	Battery voltage
		Stop lamp switch 2 (With ICC)		Stop lamp switch OFF (Brake pedal is not depressed) and ICC brake hold relay OFF	0 V	
				Stop lamp switch ON (Brake pedal is de- pressed) or ICC brake hold relay ON	Battery voltage	
119 (GR)	Ground	Driver side door lock assembly (Unlock sensor)	Input	Driver door	LOCK status (Unlock sensor switch OFF)	 <p style="text-align: right; font-size: small;">JPMIA0012GB</p>
					UNLOCK status (Unlock switch sensor ON)	1.1 V
					0 V	

A
B
C
D
E
F
G
H
I
J
L
M
N
O
P

SEC

BCM (BODY CONTROL MODULE)

< ECU DIAGNOSIS INFORMATION >

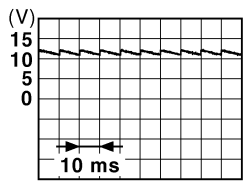
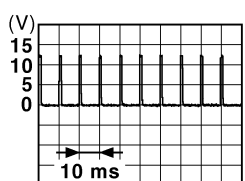
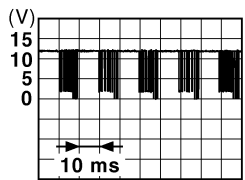
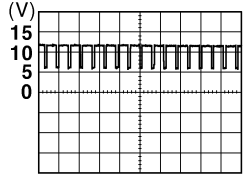
Terminal No. (Wire color)		Description		Condition	Value (Approx.)	
		Signal name	Input/ Output			
+	-					
121 (SB)	Ground	Key slot switch	Input	When the Intelligent Key is inserted into key slot	12 V	
				When the Intelligent Key is not inserted into key slot	0 V	
123 (W)	Ground	IGN feedback	Input	Ignition switch	OFF or ACC	0 V
					ON	Battery voltage
124 (BG)	Ground	Passenger door switch	Input	Passenger door switch	OFF (Door close)	 <small>JPMIA0011GB</small> 11.8 V
					ON (Door open)	0 V
129 (BG)	Ground	Trunk lid opener cancel switch	Input	Trunk lid opener cancel switch	CANCEL	 <small>JPMIA0012GB</small> 1.1 V
					ON	0 V
132 (LG)	Ground	Power window switch and R.H.T. control unit communication	Input/ Output	Ignition switch ON	 <small>JPMIA0013GB</small> 10.2 V	
				Ignition switch OFF or ACC	12 V	
133 (Y)	Ground	Push-button ignition switch illumination	Output	Push-button ignition switch illumination	ON (Tail lamps OFF)	9.5 V
					ON (Tail lamps ON)	<p style="text-align: center;">NOTE: The pulse width of this wave is varied by the illumination brightening/dimming level.</p>  <small>JPMIA0159GB</small>
					OFF	0 V
134 (LG)	Ground	LOCK indicator lamp	Output	LOCK indicator lamp	OFF	Battery voltage
					ON	0 V
137 (BG)	Ground	Receiver and sensor ground	Input	Ignition switch ON	0 V	

BCM (BODY CONTROL MODULE)

< ECU DIAGNOSIS INFORMATION >

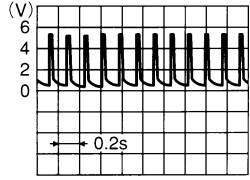
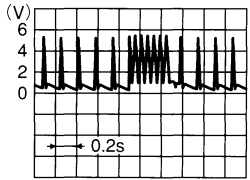
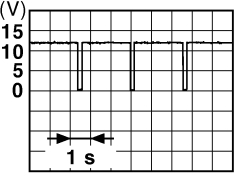
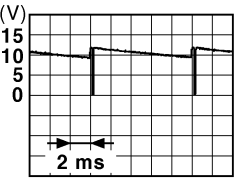
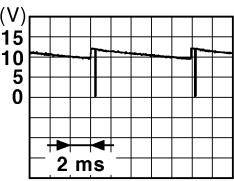
Terminal No. (Wire color)		Description		Condition		Value (Approx.)
+	-	Signal name	Input/ Output			
138 (Y)	Ground	Receiver and sensor power supply	Output	Ignition switch	OFF	0 V
					ACC or ON	5.0 V
139 (L)	Ground	Tire pressure receiver communication	Input/ Output	Ignition switch ON	Standby state	 OCC3881D
					When receiving the signal from the transmitter	 OCC3880D
140 (GR)	Ground	Selector lever P/N position (A/T models)	Input	Selector lever	P or N position	12 V
					Except P and N positions	0 V
141 (R)	Ground	Security indicator lamp	Output	Security indica- tor lamp	ON	0 V
					Blinking	 JPMAI0014GB 11.3 V
					OFF	12 V
142 (BR)	Ground	Combination switch OUTPUT 5	Output	Combination switch (Wiper volume dial 4)	All switches OFF	0 V
					Lighting switch 1ST	 JPMAI0031GB 10.7 V
					Lighting switch HI	
					Lighting switch 2ND	
Turn signal switch RH						
143 (V)	Ground	Combination switch OUTPUT 1	Output	Combination switch	All switches OFF (Wiper volume dial 4)	0 V
					Front wiper switch HI (Wiper volume dial 4)	 JPMAI0032GB 10.7 V
					Any of the conditions below with all switches OFF <ul style="list-style-type: none"> • Wiper volume dial 1 • Wiper volume dial 2 • Wiper volume dial 3 • Wiper volume dial 6 • Wiper volume dial 7 	

A

B

C

D

E

F

G

H

I

J

SEC

L

M

N

O

P

BCM (BODY CONTROL MODULE)

< ECU DIAGNOSIS INFORMATION >

Terminal No. (Wire color)		Description		Condition	Value (Approx.)	
+	-	Signal name	Input/ Output			
144 (G)	Ground	Combination switch OUTPUT 2	Output	Combination switch	All switches OFF (Wiper volume dial 4)	0 V
					Front washer switch ON (Wiper volume dial 4)	
					Any of the conditions below with all switches OFF <ul style="list-style-type: none"> • Wiper volume dial 1 • Wiper volume dial 5 • Wiper volume dial 6 	
10.7 V						
145 (L)	Ground	Combination switch OUTPUT 3	Output	Combination switch (Wiper volume dial 4)	All switches OFF	0 V
					Front wiper switch INT/ AUTO	
					Front wiper switch LO	
Lighting switch AUTO	10.7 V					
146 (SB)	Ground	Combination switch OUTPUT 4	Output	Combination switch (Wiper volume dial 4)	All switches OFF	0 V
					Front fog lamp switch ON	
					Lighting switch 2ND	
					Lighting switch PASS	
Turn signal switch LH	10.7 V					
150 (R)	Ground	Driver door switch	Input	Driver door switch	OFF (Door close)	
					ON (Door open)	0 V
151 (G)	Ground	Rear window defog- ger relay control	Output	Rear window defogger	Active	0 V
				Not activated	Battery voltage	

*1: Without steering lock unit

*2: With steering lock unit

BCM (BODY CONTROL MODULE)

< ECU DIAGNOSIS INFORMATION >

Wiring Diagram - BCM -

INFOID:000000006956339

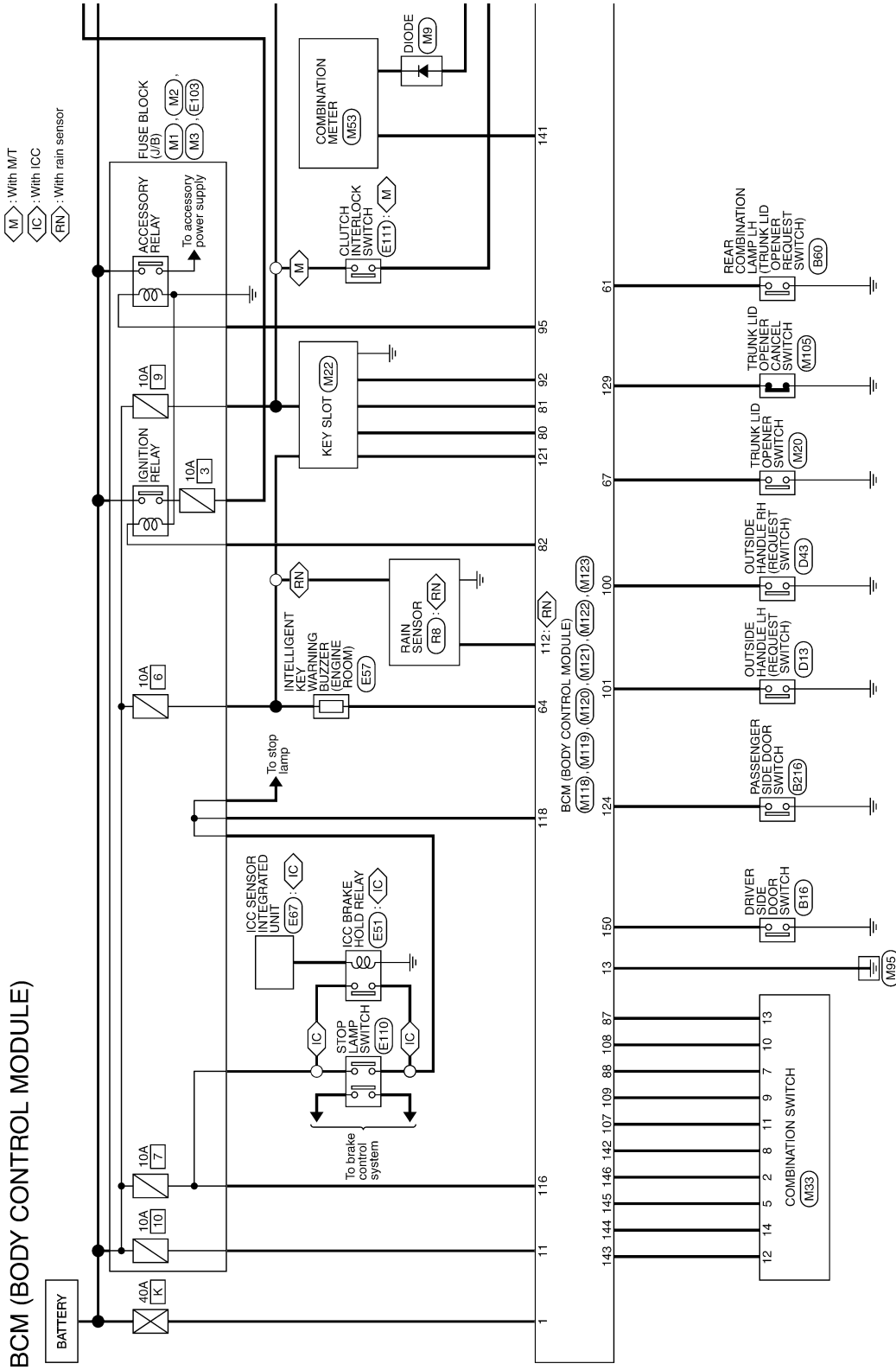

2010/10/12

JCMWN0248GB

A
B
C
D
E
F
G
H
I
J
K
L
M
N
O
P

SEC

BCM (BODY CONTROL MODULE)

< ECU DIAGNOSIS INFORMATION >

- SL : With steering lock unit
- XS : Without steering lock unit
- A : With A/T
- M : With M/T
- *1
- 89
- 60

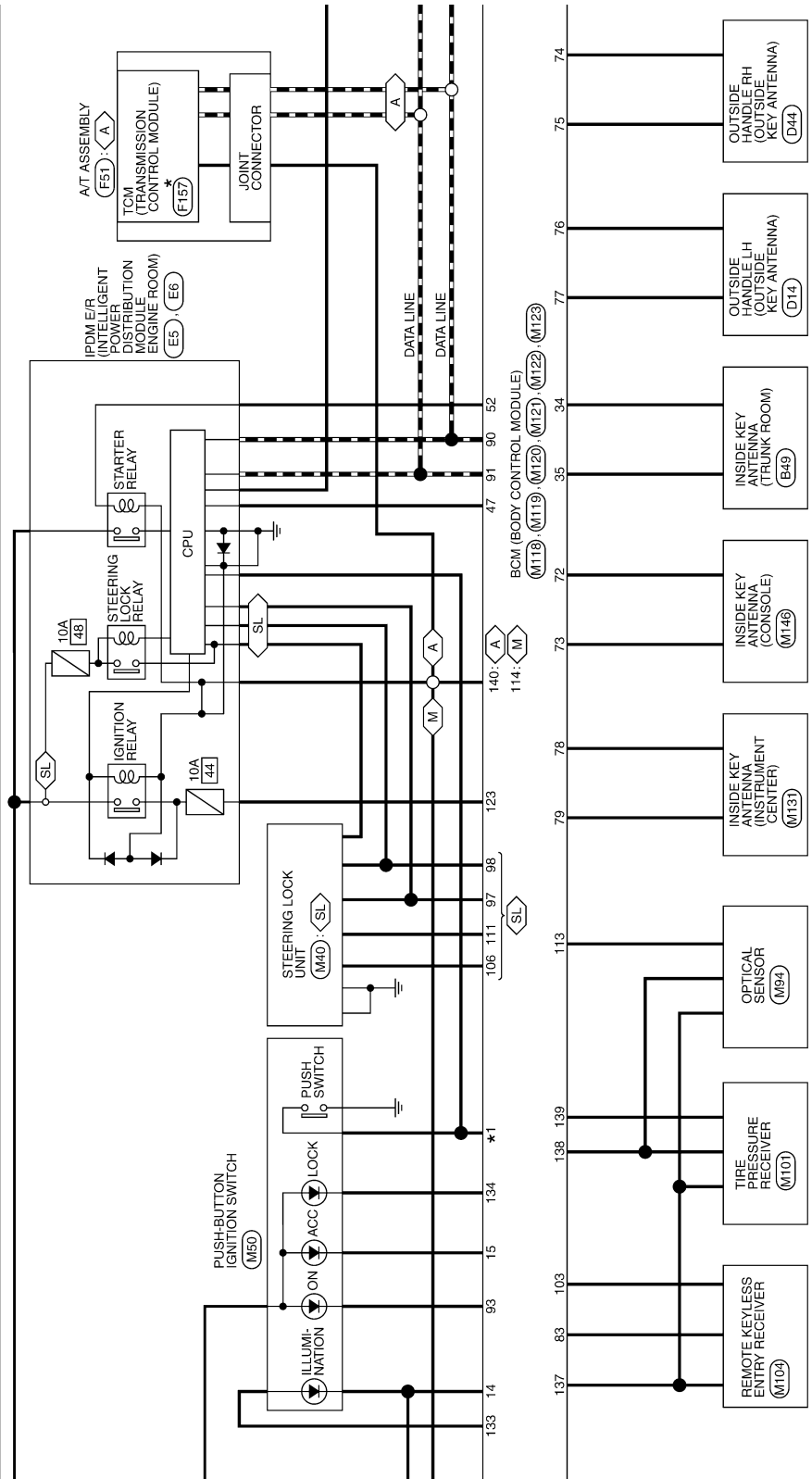

*: This connector is not shown in "Harness Layout".

JCMWN0249GB

BCM (BODY CONTROL MODULE)

< ECU DIAGNOSIS INFORMATION >

◊ A : With A/T
 ◊ M : With M/T

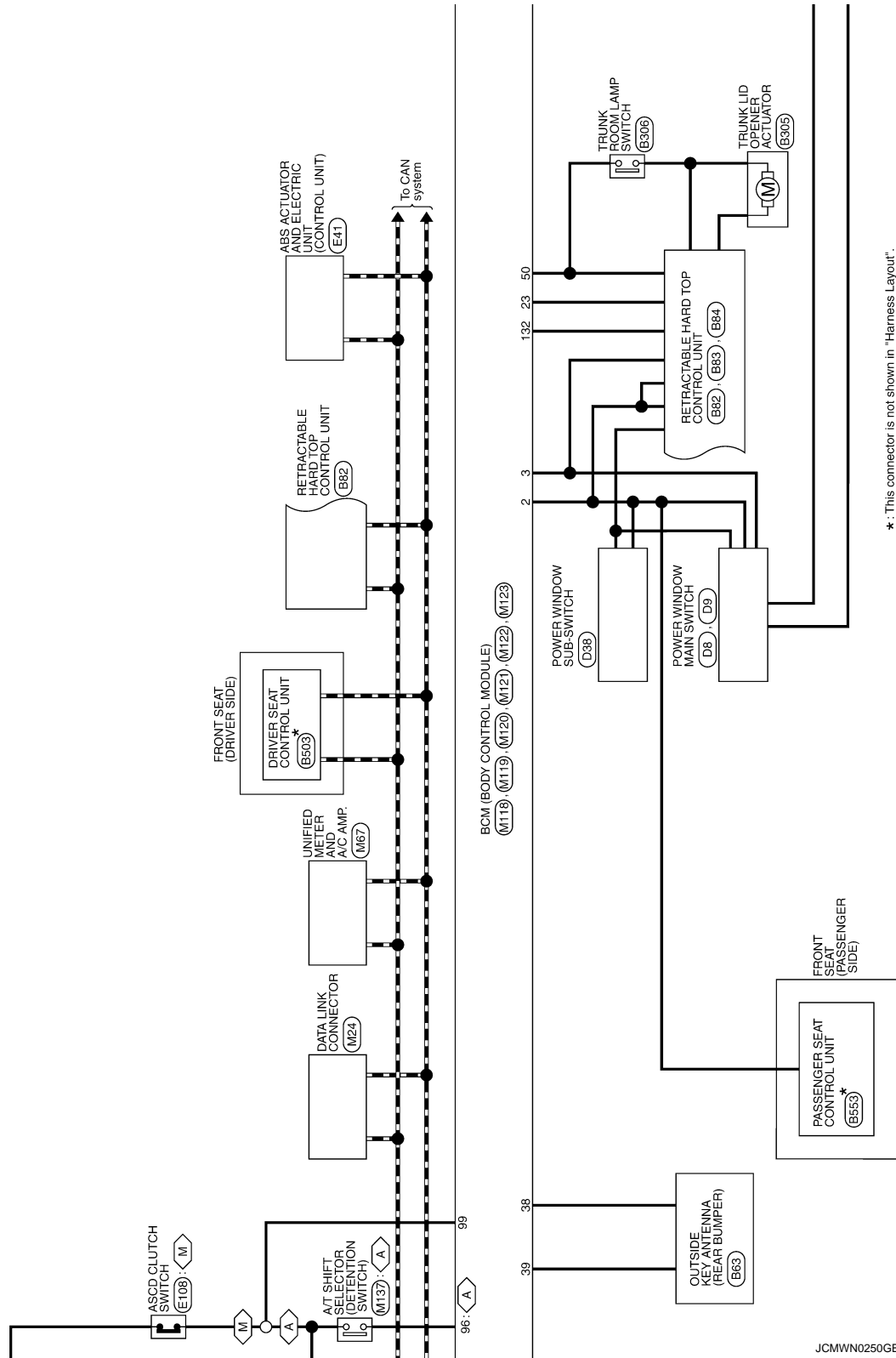

*: This connector is not shown in "Harness Layout".

JCMWN0250GB

A
B
C
D
E
F
G
H
I
J
L
M
N
O
P

SEC

BCM (BODY CONTROL MODULE)

< ECU DIAGNOSIS INFORMATION >

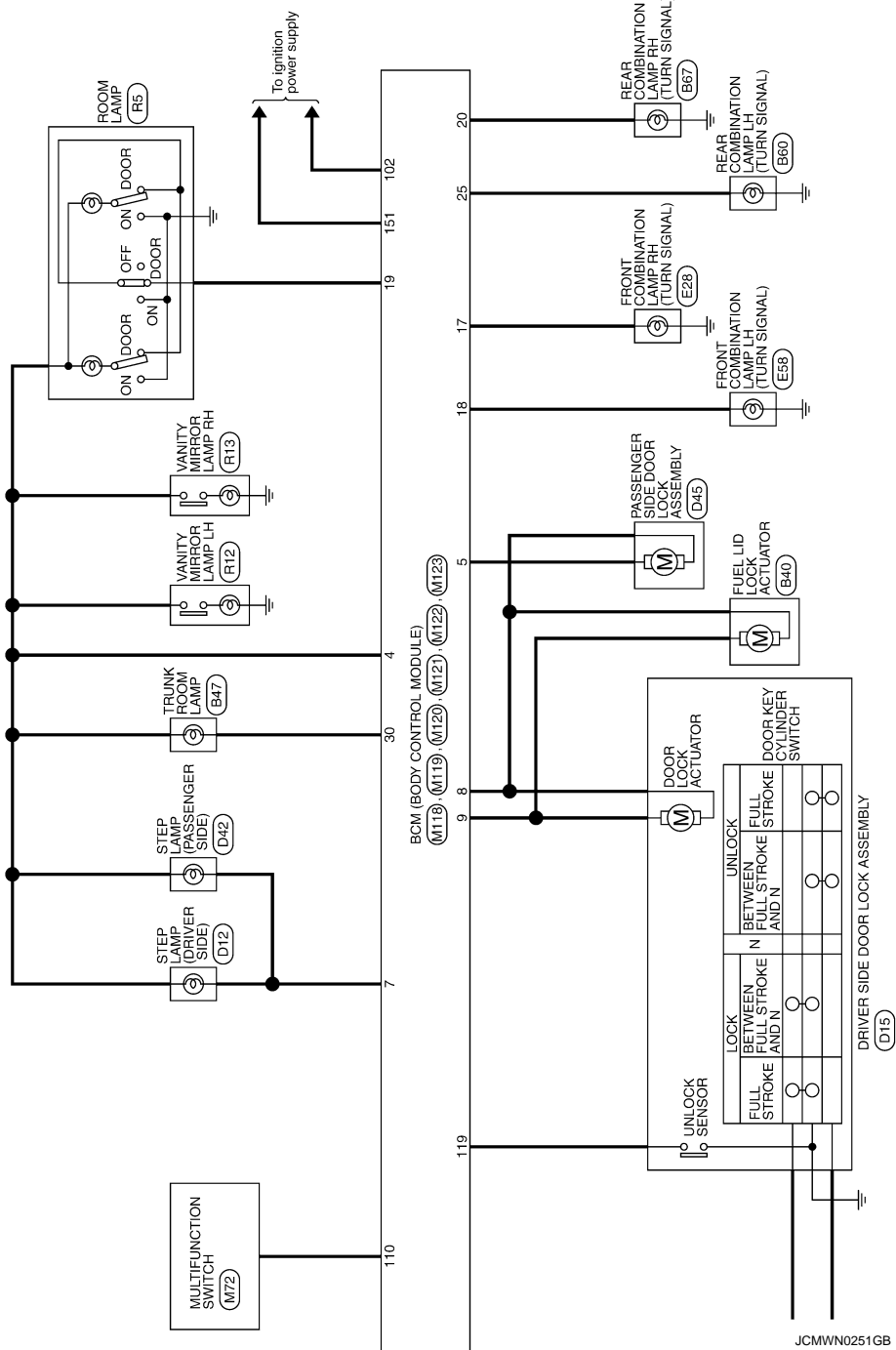

BCM (BODY CONTROL MODULE)

< ECU DIAGNOSIS INFORMATION >

BCM (BODY CONTROL MODULE)

Connector No.	M33
Connector Name	COMBINATION SWITCH
Connector Type	TH167V-NH



Terminal No.	Color of Wire	Signal Name [Specification]
1	P	FR WASHER (-)
2	SB	OUTPUT 4
5	L	OUTPUT 3
6	B	GND
7	EG	INPUT 3
8	BR	OUTPUT 5
9	W	INPUT 2
10	R	INPUT 4
11	LG	INPUT 1
12	V	OUTPUT 1
13	Y	INPUT 5
14	G	OUTPUT 2

Connector No.	M18
Connector Name	BCM (BODY CONTROL MODULE)
Connector Type	M03FB-LG



Terminal No.	Color of Wire	Signal Name [Specification]
1	W	BAT (F/L)
2	Y	POWER WINDOW POWER SUPPLY (BAT)
3	EG	POWER WINDOW POWER SUPPLY (RAP)

Connector No.	M119
Connector Name	BCM (BODY CONTROL MODULE)
Connector Type	NS16FF-CS



Terminal No.	Color of Wire	Signal Name [Specification]
4	LG	INTERIOR ROOM LAMP POWER SUPPLY
5	P	PASSENGER DOOR UNLOCK OUTPUT
7	SB	STEP LAMP
8	V	ALL DOOR FUEL LID LOCK OUTPUT
9	G	DRIVER DOOR FUEL LID UNLOCK OUTPUT
11	GR	BAT (FUSE)
13	B	GND
14	W	PUSH BUTTON IGNITION SW ILL GND
15	EG	ACC IND
17	BR	TURN SIGNAL RH (FRONT)
18	EG	TURN SIGNAL LH (FRONT)
19	V	ROOM LAMP TIMER CONTROL

Connector No.	M120
Connector Name	BCM (BODY CONTROL MODULE)
Connector Type	NS12FW-CS



Terminal No.	Color of Wire	Signal Name [Specification]
20	V	TURN SIGNAL RH (REAR)
23	Y	TRUNK LID OPEN OUTPUT
25	Y	TURN SIGNAL LH (REAR)
30	P	TRUNK ROOM LAMP

Connector No.	M121
Connector Name	BCM (BODY CONTROL MODULE)
Connector Type	TH40FGY-NH



Terminal No.	Color of Wire	Signal Name [Specification]
34	SB	TRUNK ROOM ANT-
35	V	TRUNK ROOM ANT+
38	B	REAR BUMPER ANT-
39	W	REAR BUMPER ANT+
47	Y	IGN RELAY (BDM F/R) CONT
50	G	TRUNK ROOM LAMP SW
52	BR	STARTER RELAY CONT
60	BR	PUSH SW
61	SB	TRUNK LID OPENER REQUEST SW
64	G	I-KEY WARN BUZZER (ENG ROOM)
67	GR	TRUNK LID OPENER SW

Connector No.	M122
Connector Name	BCM (BODY CONTROL MODULE)
Connector Type	TH40FB-NH



Terminal No.	Color of Wire	Signal Name [Specification]
72	R	ROOM ANT 2-
73	G	ROOM ANT 2+
74	SB	PASSENGER DOOR ANT-
75	BR	PASSENGER DOOR ANT+
76	V	DRIVER DOOR ANT-
77	LG	DRIVER DOOR ANT+
78	Y	ROOM ANT 1-
79	BR	ROOM ANT 1+
80	GR	NATS ANTENNA AMP
81	W	NATS ANTENNA AMP
82	R	IGN RELAY (F/B) CONT

83	Y	KEYLESS ENTRY RECEIVER COMM
87	Y	COMBI SW INPUT 5
88	EG	COMBI SW INPUT 3
89	BR	PUSH SW
90	P	CAN-L
91	L	CAN-H
92	LG	KEY SLOT ILL
93	V	ACC RELAY CONT
95	EG	ACC RELAY CONT
96	GR	A/T SHIFT SELECTOR POWER SUPPLY
97	L	S/L CONDITION 1
98	SB	S/L CONDITION 2
99	R	ASGD CLUTCH SW [With M/T]
99	R	SHIFT P [With A/T]
100	Y	PASSENGER DOOR REQUEST SW
101	P	DRIVER DOOR REQUEST SW
102	EG	BLOWER FAN MOTOR RELAY CONT
103	LG	KEYLESS ENTRY RECEIVER POWER SUPPLY
106	W	S/L UNIT POWER SUPPLY
107	LG	COMBI SW INPUT 1
108	R	COMBI SW INPUT 4
109	W	COMBI SW INPUT 2
110	G	HAZARD SW
111	Y	S/L UNIT COMM

A
B
C
D
E
F
G
H
I
J
K
L
M
N
O
P

SEC

BCM (BODY CONTROL MODULE)

< ECU DIAGNOSIS INFORMATION >

BCM (BODY CONTROL MODULE)	
Connector No.	M123
Connector Name	BCM (BODY CONTROL MODULE)
Connector Type	TH40FG-1N1

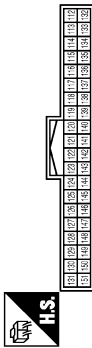

Terminal No.	Color of Wire	Signal Name [Specification]
112	BR	RAIN SENSOR SERIAL LINK
113	G	OPTICAL SENSOR
114	R	CLUTCH INTERLOCK SW
116	SB	STOP LAMP SW 1
118	BR	STOP LAMP SW 2
119	GR	DR DOOR UNLOCK SENSOR
121	SB	KEY SLOT SW
123	W	IGN P/B
124	EG	PASSENGER DOOR SW
129	EG	TRUNK LID OPENER CANCEL SW
132	LG	P/W SW & PRT C/U COMM
133	Y	PUSH-BUTTON IGNITION SW ILL POWER
134	LG	LOCK IND
137	BG	RECEIVER / SENSOR GND
138	Y	RECEIVER / SENSOR POWER SUPPLY
139	L	TIRE PRESSURE RECEIVER COMM
140	GR	SHIFT N/P
141	R	SECURITY INDICATOR LAMP
142	BR	COMBI SW OUTPUT 5
143	V	COMBI SW OUTPUT 1
144	G	COMBI SW OUTPUT 2
145	L	COMBI SW OUTPUT 3
146	SB	COMBI SW OUTPUT 4
150	R	DRIVER DOOR SW
151	G	REAR WINDOW DEFOGGER RELAY CONT

JCMWN0253GB

Fail-safe

INFOID:000000006956340

FAIL-SAFE CONTROL BY DTC

BCM performs fail-safe control when any DTC are detected.

BCM (BODY CONTROL MODULE)

< ECU DIAGNOSIS INFORMATION >

Display contents of CONSULT	Fail-safe	Cancellation	A
B2013: ID DISCORD BCM-S/L	Inhibit engine cranking	Erase DTC	A
B2014: CHAIN OF S/L-BCM	Inhibit engine cranking	Erase DTC	B
B2190: NATS ANTENNA AMP	Inhibit engine cranking	Erase DTC	B
B2191: DIFFERENCE OF KEY	Inhibit engine cranking	Erase DTC	C
B2192: ID DISCORD BCM-ECM	Inhibit engine cranking	Erase DTC	C
B2193: CHAIN OF BCM-ECM	Inhibit engine cranking	Erase DTC	D
B2195: ANTI-SCANNING	Inhibit engine cranking	Ignition switch ON → OFF	D
B2557: VEHICLE SPEED	Inhibit steering lock	When normal vehicle speed signals are received from ABS actuator and electric unit (control unit) for 500 ms	E
B2560: STARTER CONT RELAY	Inhibit engine cranking	500 ms after the following CAN signal communication status becomes consistent <ul style="list-style-type: none"> • Starter control relay signal • Starter relay status signal 	E
B2601: SHIFT POSITION	Inhibit steering lock	500 ms after the following signal reception status becomes consistent <ul style="list-style-type: none"> • Selector lever P position switch signal • P range signal (CAN) 	F
B2602: SHIFT POSITION	Inhibit steering lock	5 seconds after the following BCM recognition conditions are fulfilled <ul style="list-style-type: none"> • Ignition switch is in the ON position • Selector lever P position switch signal: Except P position (12 V) • Vehicle speed: 4 km/h (2.5 MPH) or more 	F
B2603: SHIFT POSI STATUS	Inhibit steering lock	500 ms after the following BCM recognition conditions are fulfilled <ul style="list-style-type: none"> • Ignition switch is in the ON position • Selector lever P position switch signal: Except P position (12 V) • Selector lever P/N position signal: Except P and N positions (0 V) 	G
B2604: PNP/CLUTCH SW	Inhibit steering lock	500 ms after any of the following BCM recognition conditions are fulfilled <ul style="list-style-type: none"> • Status 1 <ul style="list-style-type: none"> - Ignition switch is in the ON position - Selector lever P/N position signal: P and N position (12 V) - P range signal or N range signal (CAN): ON • Status 2 <ul style="list-style-type: none"> - Ignition switch is in the ON position - Selector lever P/N position signal: Except P and N positions (0 V) - P range signal and N range signal (CAN): OFF 	G
B2605: PNP/CLUTCH SW	Inhibit steering lock	500 ms after any of the following BCM recognition conditions are fulfilled <ul style="list-style-type: none"> • Status 1 <ul style="list-style-type: none"> - Ignition switch is in the ON position - Selector lever P/N position signal: Except P and N positions (0 V) - Interlock/PNP switch signal (CAN): OFF • Status 2 <ul style="list-style-type: none"> - Ignition switch is in the ON position - Selector lever P/N position signal: P or N position (12 V) - PNP switch signal (CAN): ON 	H
B2606: S/L RELAY	Inhibit engine cranking	500 ms after the following CAN signal communication status becomes consistent <ul style="list-style-type: none"> • Steering lock relay signal (Request signal) • Steering lock relay signal (Condition signal) 	H
B2607: S/L RELAY	Inhibit engine cranking	500 ms after the following CAN signal communication status has become consistent <ul style="list-style-type: none"> • Steering lock relay signal (Request signal) • Steering lock relay signal (Condition signal) 	I

SEC

BCM (BODY CONTROL MODULE)

< ECU DIAGNOSIS INFORMATION >

Display contents of CONSULT	Fail-safe	Cancellation
B2608: STARTER RELAY	Inhibit engine cranking	500 ms after the following signal communication status becomes consistent <ul style="list-style-type: none"> • Starter motor relay control signal • Starter relay status signal (CAN)
B2609: S/L STATUS	<ul style="list-style-type: none"> • Inhibit engine cranking • Inhibit steering lock 	When the following steering lock conditions agree <ul style="list-style-type: none"> • BCM steering lock control status • Steering lock condition No. 1 signal status • Steering lock condition No. 2 signal status
B260A: IGNITION RELAY	Inhibit engine cranking	500 ms after the following conditions are fulfilled <ul style="list-style-type: none"> • IGN relay (IPDM E/R) control signal: OFF (12 V) • Ignition ON signal (CAN to IPDM E/R): OFF (Request signal) • Ignition ON signal (CAN from IPDM E/R): OFF (Condition signal)
B260F: ENG STATE SIG LOST	Maintains the power supply position attained at the time of DTC detection	When any of the following conditions are fulfilled <ul style="list-style-type: none"> • Power position changes to ACC • Receives engine status signal (CAN)
B2612: S/L STATUS	<ul style="list-style-type: none"> • Inhibit engine cranking • Inhibit steering lock 	When any of the following conditions are fulfilled <ul style="list-style-type: none"> • Steering lock unit status signal (CAN) is received normally • The BCM steering lock control status matches the steering lock status recognized by the steering lock unit status signal (CAN from IPDM E/R)
B2617: BCM	Inhibit engine cranking	1 second after the starter motor relay control inside BCM becomes normal
B2618: BCM	Inhibit engine cranking	1 second after the ignition relay (IPDM E/R) control inside BCM becomes normal
B2619: BCM	Inhibit engine cranking	1 second after the steering lock unit power supply output control inside BCM becomes normal
B261E: VEHICLE TYPE	Inhibit engine cranking	BCM initialization
B26E8: CLUTCH SW	Inhibit engine cranking	When any of the following BCM recognition conditions are fulfilled <ul style="list-style-type: none"> • Status 1 <ul style="list-style-type: none"> - Clutch switch signal (CAN from ECM): ON - Clutch interlock switch signal: OFF (0 V) • Status 2 <ul style="list-style-type: none"> - Clutch switch signal (CAN from ECM): OFF - Clutch interlock switch signal: ON (Battery voltage)
B26E9: S/L STATUS	<ul style="list-style-type: none"> • Inhibit engine cranking • Inhibit steering lock 	When BCM transmits the LOCK request signal to steering lock unit, and receives LOCK response signal from steering lock unit, the following conditions are fulfilled <ul style="list-style-type: none"> • Steering condition No. 1 signal: LOCK (0 V) • Steering condition No. 2 signal: LOCK (12 V)

DTC Inspection Priority Chart

INFOID:000000006956341

If some DTCs are displayed at the same time, perform inspections one by one based on the following priority chart.

Priority	DTC
1	B2562: LOW VOLTAGE
2	<ul style="list-style-type: none"> • U1000: CAN COMM • U1010: CONTROL UNIT (CAN)
3	<ul style="list-style-type: none"> • B2190: NATS ANTENNA AMP • B2191: DIFFERENCE OF KEY • B2192: ID DISCORD BCM-ECM • B2193: CHAIN OF BCM-ECM • B2195: ANTI-SCANNING

BCM (BODY CONTROL MODULE)

< ECU DIAGNOSIS INFORMATION >

Priority	DTC	
4	• B2013: ID DISCORD BCM-S/L	A
	• B2014: CHAIN OF S/L-BCM	
	• B2553: IGNITION RELAY	
	• B2555: STOP LAMP	B
	• B2556: PUSH-BTN IGN SW	
	• B2557: VEHICLE SPEED	
	• B2560: STARTER CONT RELAY	
	• B2601: SHIFT POSITION	C
	• B2602: SHIFT POSITION	
	• B2603: SHIFT POSI STATUS	
	• B2604: PNP/CLUTCH SW	
	• B2605: PNP/CLUTCH SW	D
	• B2606: S/L RELAY	
	• B2607: S/L RELAY	
	• B2608: STARTER RELAY	
	• B2609: S/L STATUS	E
	• B260A: IGNITION RELAY	
	• B260B: STEERING LOCK UNIT	
	• B260C: STEERING LOCK UNIT	F
	• B260D: STEERING LOCK UNIT	
	• B260F: ENG STATE SIG LOST	
	• B2612: S/L STATUS	
	• B2614: BCM	G
	• B2615: BCM	
	• B2616: BCM	
	• B2617: BCMC	
• B2618: BCM	H	
• B2619: BCM		
• B261A: PUSH-BTN IGN SW		
• B261E: VEHICLE TYPE		
• B26E8: CLUTCH SW	I	
• B26E9: S/L STATUS		
• B26EA: KEY REGISTRATION		
• C1729: VHCL SPEED SIG ERR	J	
• U0415: VEHICLE SPEED		
5	• C1704: LOW PRESSURE FL	
	• C1705: LOW PRESSURE FR	
	• C1706: LOW PRESSURE RR	
	• C1707: LOW PRESSURE RL	
	• C1708: [NO DATA] FL	
	• C1709: [NO DATA] FR	
	• C1710: [NO DATA] RR	
	• C1711: [NO DATA] RL	
	• C1716: [PRESSDATA ERR] FL	
	• C1717: [PRESSDATA ERR] FR	
	• C1718: [PRESSDATA ERR] RR	
	• C1719: [PRESSDATA ERR] RL	
	• C1734: CONTROL UNIT	
6	• B2621: INSIDE ANTENNA	
	• B2622: INSIDE ANTENNA	
	• B2623: INSIDE ANTENNA	

SEC

DTC Index

INFOID:000000006956342

NOTE:

The details of time display are as follows.

- CRNT: A malfunction is detected now.
- PAST: A malfunction was detected in the past.

IGN counter is displayed on Freeze Frame Data. For details of Freeze Frame Data, refer to [SEC-24. "COMMON ITEM : CONSULT-III Function \(BCM - COMMON ITEM\)"](#).

BCM (BODY CONTROL MODULE)

< ECU DIAGNOSIS INFORMATION >

CONSULT display	Fail-safe	Freeze Frame Data •Vehicle Speed •Odo/Trip Meter •Vehicle condition	Intelligent Key warning lamp ON	Tire pressure monitor warning lamp ON	Refer- ence page
No DTC is detected. further testing may be required.	—	—	—	—	—
U1000: CAN COMM	—	—	—	—	BCS-35
U1010: CONTROL UNIT (CAN)	—	—	—	—	BCS-36
U0415: VEHICLE SPEED	—	—	—	—	BCS-37
B2013: ID DISCORD BCM-S/L*	×	×	—	—	SEC-49
B2014: CHAIN OF S/L-BCM*	×	×	—	—	SEC-50
B2190: NATS ANTENNA AMP	×	—	—	—	SEC-41
B2191: DIFFERENCE OF KEY	×	—	—	—	SEC-44
B2192: ID DISCORD BCM-ECM	×	—	—	—	SEC-45
B2193: CHAIN OF BCM-ECM	×	—	—	—	SEC-47
B2195: ANTI-SCANNING	×	—	—	—	SEC-48
B2553: IGNITION RELAY	—	×	—	—	PCS-49
B2555: STOP LAMP	—	×	—	—	SEC-53
B2556: PUSH-BTN IGN SW	—	×	×	—	SEC-55
B2557: VEHICLE SPEED	×	×	×	—	SEC-57
B2560: STARTER CONT RELAY	×	×	×	—	SEC-58
B2562: LOW VOLTAGE	—	×	—	—	BCS-38
B2601: SHIFT POSITION	×	×	×	—	SEC-59
B2602: SHIFT POSITION	×	×	×	—	SEC-62
B2603: SHIFT POSI STATUS	×	×	×	—	SEC-64
B2604: PNP/CLUTCH SW	×	×	×	—	SEC-67
B2605: PNP/CLUTCH SW	×	×	×	—	SEC-69
B2606: S/L RELAY*	×	×	×	—	SEC-71
B2607: S/L RELAY*	×	×	×	—	SEC-72
B2608: STARTER RELAY	×	×	×	—	SEC-74
B2609: S/L STATUS*	×	×	×	—	SEC-76
B260A: IGNITION RELAY	×	×	×	—	PCS-51
B260B: STEERING LOCK UNIT*	—	×	×	—	SEC-80
B260C: STEERING LOCK UNIT*	—	×	×	—	SEC-81
B260D: STEERING LOCK UNIT*	—	×	×	—	SEC-82
B260F: ENG STATE SIG LOST	×	×	×	—	SEC-83
B2612: S/L STATUS*	×	×	×	—	SEC-88
B2614: BCM	—	×	×	—	PCS-53
B2615: BCM	—	×	×	—	PCS-56
B2616: BCM	—	×	×	—	PCS-59
B2617: BCM	×	×	×	—	SEC-92
B2618: BCM	×	×	×	—	PCS-62
B2619: BCM*	×	×	×	—	SEC-94
B261A: PUSH-BTN IGN SW	—	×	×	—	PCS-63
B261E: VEHICLE TYPE	×	×	× (Turn ON for 15 seconds)	—	SEC-95

BCM (BODY CONTROL MODULE)

< ECU DIAGNOSIS INFORMATION >

CONSULT display	Fail-safe	Freeze Frame Data •Vehicle Speed •Odo/Trip Meter •Vehicle condition	Intelligent Key warning lamp ON	Tire pressure monitor warning lamp ON	Refer- ence page	
B2621: INSIDE ANTENNA	—	×	—	—	DLK-62	A
B2622: INSIDE ANTENNA	—	×	—	—	DLK-64	B
B2623: INSIDE ANTENNA	—	×	—	—	DLK-66	
B26E8: CLUTCH SW	×	×	×	—	SEC-84	C
B26E9: S/L STATUS*	×	×	× (Turn ON for 15 seconds)	—	SEC-86	D
B26EA: KEY REGISTRATION	—	×	× (Turn ON for 15 seconds)	—	SEC-87	D
C1704: LOW PRESSURE FL	—	—	—	×	WT-24	E
C1705: LOW PRESSURE FR	—	—	—	×		
C1706: LOW PRESSURE RR	—	—	—	×		
C1707: LOW PRESSURE RL	—	—	—	×		
C1708: [NO DATA] FL	—	—	—	×	WT-26	F
C1709: [NO DATA] FR	—	—	—	×		
C1710: [NO DATA] RR	—	—	—	×		
C1711: [NO DATA] RL	—	—	—	×		
C1716: [PRESSDATA ERR] FL	—	—	—	×	WT-29	H
C1717: [PRESSDATA ERR] FR	—	—	—	×		
C1718: [PRESSDATA ERR] RR	—	—	—	×		
C1719: [PRESSDATA ERR] RL	—	—	—	×		
C1729: VHCL SPEED SIG ERR	—	—	—	×	WT-30	I
C1734: CONTROL UNIT	—	—	—	×	WT-31	J

*: For models without steering lock unit, this DTC is not applied.

SEC

L

M

N

O

P

IPDM E/R (INTELLIGENT POWER DISTRIBUTION MODULE ENGINE ROOM)

< ECU DIAGNOSIS INFORMATION >

IPDM E/R (INTELLIGENT POWER DISTRIBUTION MODULE ENGINE ROOM)

Reference Value

INFOID:000000006956334

VALUES ON THE DIAGNOSIS TOOL

Monitor Item	Condition		Value/Status
RAD FAN REQ	Engine idle speed	Changes depending on engine coolant temperature, air conditioner operation status, vehicle speed, etc.	0 - 100 %
AC COMP REQ	Engine running	A/C switch OFF	Off
		A/C switch ON (Compressor is operating)	On
TAIL&CLR REQ	Lighting switch OFF		Off
	Lighting switch 1ST, 2ND, HI or AUTO (Light is illuminated)		On
HL LO REQ	Lighting switch OFF		Off
	Lighting switch 2ND HI or AUTO (Light is illuminated)		On
HL HI REQ	Lighting switch OFF		Off
	Lighting switch HI		On
FR FOG REQ	Lighting switch 2ND or AUTO (Light is illuminated)	Front fog lamp switch OFF	Off
		<ul style="list-style-type: none"> • Front fog lamp switch ON • Daytime running light activated (Only for Canada) 	On
FR WIP REQ	Ignition switch ON	Front wiper switch OFF	Stop
		Front wiper switch INT	1LOW
		Front wiper switch LO	Low
		Front wiper switch HI	Hi
WIP AUTO STOP	Ignition switch ON	Front wiper stop position	STOP P
		Any position other than front wiper stop position	ACT P
WIP PROT	Ignition switch ON	Front wiper operates normally	Off
		Front wiper stops at fail-safe operation	BLOCK
IGN RLY1 -REQ	Ignition switch OFF or ACC		Off
	Ignition switch ON		On
IGN RLY	Ignition switch OFF or ACC		Off
	Ignition switch ON		On
PUSH SW	Release the push-button ignition switch		Off
	Press the push-button ignition switch		On
INTER/NP SW	Ignition switch ON	Selector lever in any position other than P or N (A/T models)	Off
		Release clutch pedal (M/T models)	
	Ignition switch ON	Selector lever in P or N position (A/T models)	On
		Depress clutch pedal (M/T models)	
ST RLY CONT	Ignition switch ON		Off
	At engine cranking		On

IPDM E/R (INTELLIGENT POWER DISTRIBUTION MODULE ENGINE ROOM)

< ECU DIAGNOSIS INFORMATION >

Monitor Item	Condition	Value/Status
IHBT RLY -REQ	Ignition switch ON	Off
	At engine cranking	On
ST/INHI RLY	Ignition switch ON	Off
	At engine cranking	INHI ON → ST ON
	The status of starter relay or starter control relay cannot be recognized by the battery voltage malfunction, etc. when the starter relay is ON and the starter control relay is OFF	UNKWN
DETENT SW	Ignition switch ON <ul style="list-style-type: none"> Press the selector button with selector lever in P position Selector lever in any position other than P 	Off
	Release the selector button with selector lever in P position NOTE: Fixed On for M/T models	On
S/L RLY -REQ NOTE: For models without steering lock unit, this item is not monitored.	None of the conditions below are present	Off
	<ul style="list-style-type: none"> Open the driver door after the ignition switch is turned OFF (for a few seconds) Press the push-button ignition switch when the steering lock is activated Depress the clutch pedal when the steering lock is activated 	On
S/L STATE NOTE: For models without steering lock unit, this item is not monitored.	Steering lock is activated	LOCK
	Steering lock is deactivated	UNLOCK
	[DTC: B210A] is detected	UNKWN
DTRL REQ	NOTE: The item is indicated, but not monitored.	Off
OIL P SW	Ignition switch OFF, ACC or engine running	Open
	Ignition switch ON	Close
HOOD SW	Close the hood	Off
	Open the hood	On
HL WASHER REQ	NOTE: The item is indicated, but not monitored.	Off
THFT HRN REQ	Not operation	Off
	<ul style="list-style-type: none"> Panic alarm is activated Horn is activated with VEHICLE SECURITY (THEFT WARNING) SYSTEM 	On
HORN CHIRP	Not operating	Off
	Door locking with Intelligent Key (horn chirp mode)	On
CRNRNG LMP REQ	NOTE: The item is indicated, but not monitored.	Off

A
B
C
D
E
F
G
H
I
J
L
M
N
O
P

SEC

IPDM E/R (INTELLIGENT POWER DISTRIBUTION MODULE ENGINE ROOM)

< ECU DIAGNOSIS INFORMATION >

TERMINAL LAYOUT

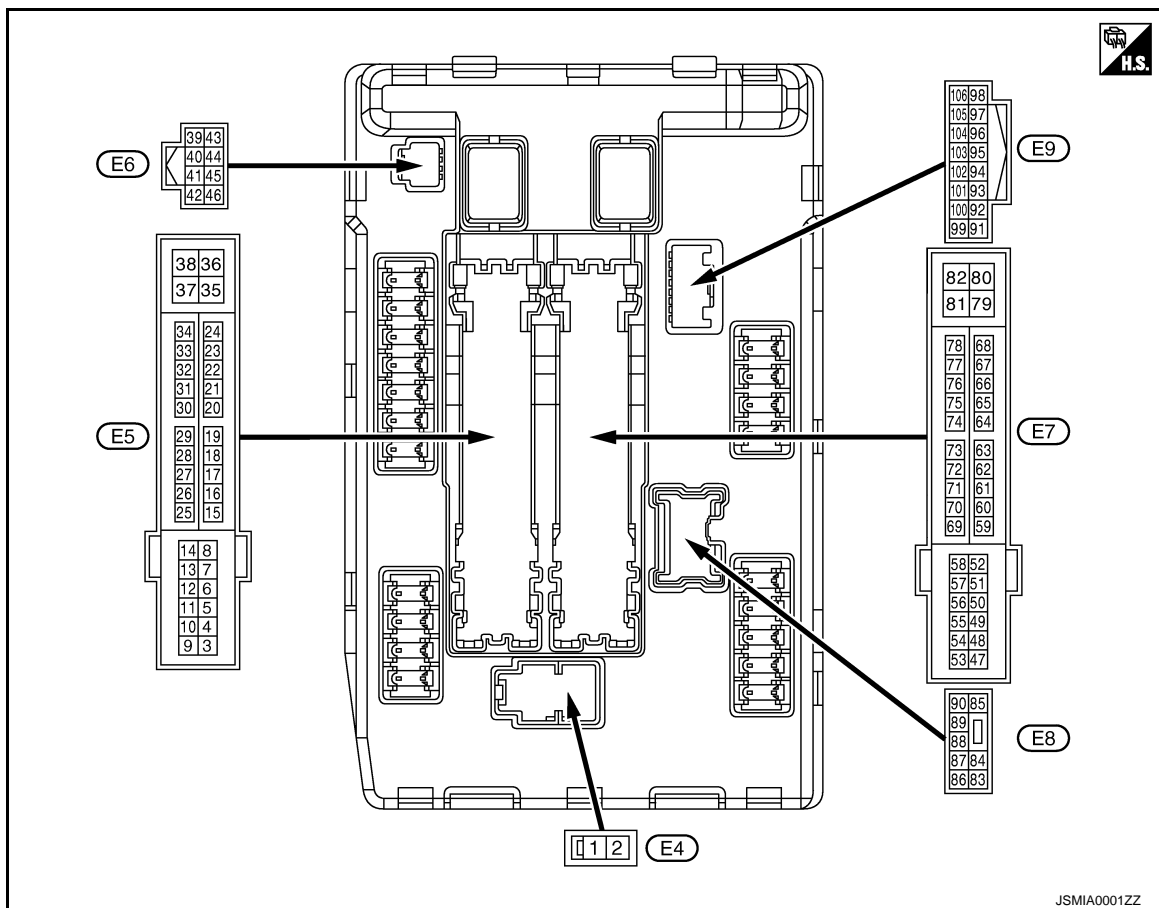

PHYSICAL VALUES

Terminal No. (Wire color)		Description		Condition		Value (Approx.)
+	-	Signal name	Input/ Output			
1 (W)	Ground	Battery power supply	Input	Ignition switch OFF		Battery voltage
2 (L)	Ground	Battery power supply	Input	Ignition switch OFF		Battery voltage
4 (V)	Ground	Front wiper LO	Output	Ignition switch OFF	Front wiper switch OFF	0 V
				Ignition switch ON	Front wiper switch LO	Battery voltage
5 (L)	Ground	Front wiper HI	Output	Ignition switch OFF	Front wiper switch OFF	0 V
				Ignition switch ON	Front wiper switch HI	Battery voltage
6*5 (SB)	Ground	Daytime running light relay	Input	Ignition switch OFF		Battery voltage
7 (R)	Ground	Tail, license plate lamps & illuminations	Output	Ignition switch OFF	Lighting switch OFF	0 V
				Ignition switch ON	Lighting switch 1ST	Battery voltage
11*4 (BR)	Ground	Steering lock unit power supply	Output	Ignition switch OFF	A few seconds after opening the driver door	Battery voltage
				Ignition switch LOCK	Press the push-button ignition switch	Battery voltage
				Ignition switch ACC or ON		0 V

IPDM E/R (INTELLIGENT POWER DISTRIBUTION MODULE ENGINE ROOM)

< ECU DIAGNOSIS INFORMATION >

Terminal No. (Wire color)		Description		Condition	Value (Approx.)	
+	-	Signal name	Input/ Output			
12 (B/W)	Ground	Ground	—	Ignition switch ON	0 V	
13 (Y)	Ground	Fuel pump power supply	Output	Approximately 1 second or more after turning the ignition switch ON	0 V	
				<ul style="list-style-type: none"> Approximately 1 second after turning the ignition switch ON Engine running 	Battery voltage	
16 (LG)	Ground	Front wiper auto stop	Input	Ignition switch ON	0 V	
				Front wiper stop position	0 V	
				Any position other than front wiper stop position	Battery voltage	
19 (W)	Ground	Ignition relay power supply	Output	Ignition switch OFF	0 V	
				Ignition switch ON	Battery voltage	
25 (G)	Ground	Ignition relay power supply	Output	Ignition switch OFF	0 V	
				Ignition switch ON	Battery voltage	
26*1 (R)	Ground	Ignition relay power supply	Output	Ignition switch OFF	0 V	
				Ignition switch ON	Battery voltage	
27 (BG)	Ground	Ignition relay monitor	Input	Ignition switch OFF or ACC	Battery voltage	
				Ignition switch ON	0 V	
28 (L)	Ground	Push-button ignition switch	Input	Press the push-button ignition switch	0 V	
				Release the push-button ignition switch	Battery voltage	
30 (GR)	Ground	Starter relay control	Input	A/T models	Selector lever in any position other than P or N (Ignition switch ON)	0 V
					Selector lever P or N (Ignition switch ON)	Battery voltage
				M/T models	Release the clutch pedal	0 V
					Depress the clutch pedal	Battery voltage
32*4 (V)	Ground	Steering lock unit condition-1	Input	Steering lock is activated	0 V	
				Steering lock is deactivated	Battery voltage	
33*4 (P)	Ground	Steering lock unit condition-2	Input	Steering lock is activated	Battery voltage	
				Steering lock is deactivated	0 V	
36 (G)	Ground	Battery power supply	Input	Ignition switch OFF	Battery voltage	
39 (P)	—	CAN-L	Input/ Output	—	—	
40 (L)	—	CAN-H	Input/ Output	—	—	
41 (B/W)	Ground	Ground	—	Ignition switch ON	0 V	
42 (Y)	Ground	Cooling fan relay control	Input	Ignition switch OFF or ACC	0 V	
				Ignition switch ON	0.7 V	
43*2 (SB)	Ground	A/T shift selector (Detention switch)	Input	Ignition switch ON	Press the selector button (selector lever P)	Battery voltage
					<ul style="list-style-type: none"> Selector lever in any position other than P Release the selector button (selector lever P) 	0 V

A
B
C
D
E
F
G
H
I
J
L
M
N
O
P

SEC

IPDM E/R (INTELLIGENT POWER DISTRIBUTION MODULE ENGINE ROOM)

< ECU DIAGNOSIS INFORMATION >

Terminal No. (Wire color)		Description		Condition		Value (Approx.)
+	-	Signal name	Input/ Output			
44 (LG)	Ground	Horn relay control	Input	The horn is deactivated		Battery voltage
				The horn is activated		0 V
45 (G)	Ground	Anti theft horn relay control	Input	The horn is deactivated		Battery voltage
				The horn is activated		0 V
46 (W)	Ground	Starter relay control	Input	A/T models	Selector lever in any position other than P or N (Ignition switch ON)	0 V
					Selector lever P or N (Ignition switch ON)	Battery voltage
				M/T models	Release the clutch pedal	0 V
					Depress the clutch pedal	Battery voltage
48 (BR)	Ground	A/C relay power supply	Output	Engine running	A/C switch OFF	0 V
					A/C switch ON (A/C compressor is operating)	Battery voltage
49 (BG)	Ground	ECM relay power supply	Output	Ignition switch OFF (More than a few seconds after turning ignition switch OFF)		0 V
				<ul style="list-style-type: none"> • Ignition switch ON • Ignition switch OFF (For a few seconds after turning ignition switch OFF) 		Battery voltage
51 (Y)	Ground	Ignition relay power supply	Output	Ignition switch OFF		0 V
				Ignition switch ON		Battery voltage
53 (W)	Ground	ECM relay power supply	Output	Ignition switch OFF (More than a few seconds after turning ignition switch OFF)		0 V
				<ul style="list-style-type: none"> • Ignition switch ON • Ignition switch OFF (For a few seconds after turning ignition switch OFF) 		Battery voltage
54 (P)	Ground	Throttle control motor relay power supply	Output	Ignition switch OFF (More than a few seconds after turning ignition switch OFF)		0 V
				<ul style="list-style-type: none"> • Ignition switch ON • Ignition switch OFF (For a few seconds after turning ignition switch OFF) 		Battery voltage
55 (SB)	Ground	ECM power supply	Output	Ignition switch OFF		Battery voltage
56 (LG)	Ground	Ignition relay power supply	Output	Ignition switch OFF		0 V
				Ignition switch ON		Battery voltage
57 (G)	Ground	Ignition relay power supply	Output	Ignition switch OFF		0 V
				Ignition switch ON		Battery voltage
58*2 (GR)	Ground	Ignition relay power supply	Output	Ignition switch OFF		0 V
				Ignition switch ON		Battery voltage

IPDM E/R (INTELLIGENT POWER DISTRIBUTION MODULE ENGINE ROOM)

< ECU DIAGNOSIS INFORMATION >

Terminal No. (Wire color)		Description		Condition	Value (Approx.)
+	-	Signal name	Input/ Output		
69 (BR)	Ground	ECM relay control	Output	Ignition switch OFF (More than a few seconds after turning ignition switch OFF)	Battery voltage
				<ul style="list-style-type: none"> Ignition switch ON Ignition switch OFF (For a few seconds after turning igni- tion switch OFF) 	0 - 1.5 V
70 (BG)	Ground	Throttle control motor re- lay control	Output	Ignition switch ON → OFF	0 - 1.0 V ↓ Battery voltage ↓ 0 V
				Ignition switch ON	0 - 1.0 V
73*3 (P)	Ground	Ignition relay power supply	Output	Ignition switch OFF	0 V
				Ignition switch ON	Battery voltage
74 (G)	Ground	Ignition relay power supply	Output	Ignition switch OFF	0 V
				Ignition switch ON	Battery voltage
75 (SB)	Ground	Oil pressure switch	Input	Ignition switch ON	Engine stopped 0 V
				Engine running Battery voltage	
76 (Y)	Ground	Power generation com- mand signal	Output	Ignition switch ON	<p style="text-align: right;">JPMIA0001GB 6.3 V</p>
				40% is set on "ACTIVE TEST", "AL- TERNATOR DUTY" of "ENGINE"	<p style="text-align: right;">JPMIA0002GB 3.8 V</p>
				80% is set on "ACTIVE TEST", "AL- TERNATOR DUTY" of "ENGINE"	<p style="text-align: right;">JPMIA0003GB 1.4 V</p>
77 (R)	Ground	Fuel pump relay control	Output	<ul style="list-style-type: none"> Approximately 1 second after turning the ignition switch ON Engine running 	0 - 1.0 V
				Approximately 1 second or more after turning the ignition switch ON	Battery voltage
80 (W)	Ground	Starter motor	Output	At engine cranking	Battery voltage

A
B
C
D
E
F
G
H
I
J
L
M
N
O
P

SEC

IPDM E/R (INTELLIGENT POWER DISTRIBUTION MODULE ENGINE ROOM)

< ECU DIAGNOSIS INFORMATION >

Terminal No. (Wire color)		Description		Condition		Value (Approx.)
+	-	Signal name	Input/ Output			
83 (R)	Ground	Headlamp LO (RH)	Output	Ignition switch ON	Lighting switch OFF	0 V
					Lighting switch 2ND	Battery voltage
84 (P)	Ground	Headlamp LO (LH)	Output	Ignition switch ON	Lighting switch OFF	0 V
					Lighting switch 2ND	Battery voltage
86 (W)	Ground	Front fog lamp (RH)	Output	Lighting switch 2ND	Front fog lamp switch OFF	0 V
						<ul style="list-style-type: none"> • Front fog lamp switch ON • Daytime running light activated (Only for Canada)
87 (L)	Ground	Front fog lamp (LH)	Output	Lighting switch 2ND	Front fog lamp switch OFF	0 V
						<ul style="list-style-type: none"> • Front fog lamp switch ON • Daytime running light activated (Only for Canada)
88 (G)	Ground	Washer pump power supply	Output	Ignition switch ON		Battery voltage
89 (BR)	Ground	Headlamp HI (RH)	Output	Ignition switch ON	Lighting switch OFF	0 V
						<ul style="list-style-type: none"> • Lighting switch HI • Lighting switch PASS
90 (LG)	Ground	Headlamp HI (LH)	Output	Ignition switch ON	Lighting switch OFF	0 V
						<ul style="list-style-type: none"> • Lighting switch HI • Lighting switch PASS
91 (P)	Ground	Parking lamp (RH)	Output	Ignition switch ON	Lighting switch OFF	0 V
						Lighting switch 1ST
92 (BG)	Ground	Parking lamp (LH)	Output	Ignition switch ON	Lighting switch OFF	0 V
						Lighting switch 1ST
97 (V)	Ground	Cooling fan control	Output	Engine idling		0 - 5 V
104 (LG)	Ground	Hood switch	Input	Close the hood		Battery voltage
				Open the hood		0 V
105*5 (L)	Ground	Daytime running light relay control	Output	<ul style="list-style-type: none"> • Park-ing lamp • Li- cense plate lamp • Tail lamp 	Turned OFF	Battery voltage
					Turned ON	

*1: Only for the models with ICC system

*2: A/T models only

*3: M/T models only

*4: Models with steering lock unit

*5: Models with daytime running light system

IPDM E/R (INTELLIGENT POWER DISTRIBUTION MODULE ENGINE ROOM)

< ECU DIAGNOSIS INFORMATION >

Wiring Diagram - IPDM E/R -

INFOID:000000006956335

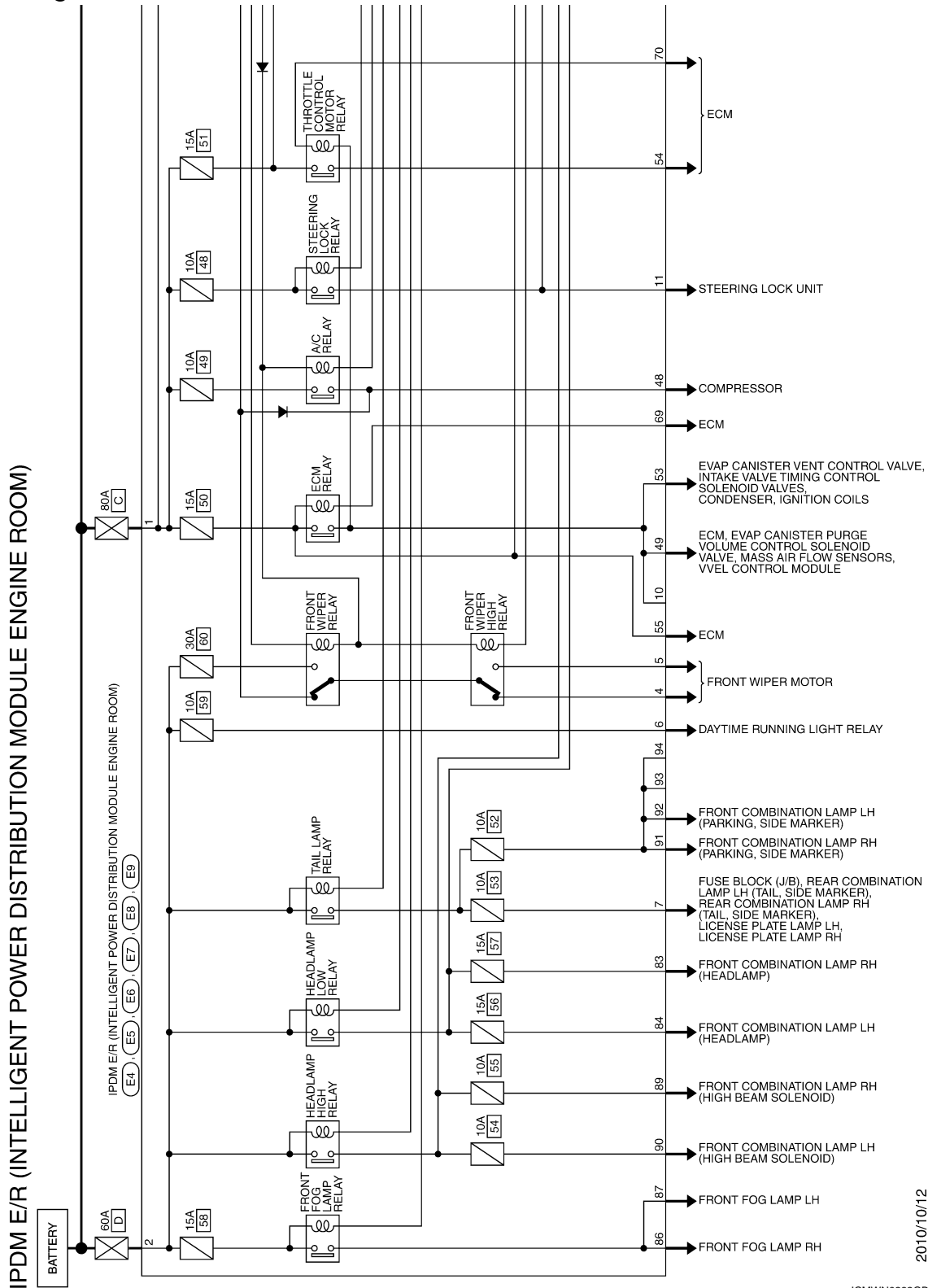

A
B
C
D
E
F
G
H
I
J
K
L
M
N
O
P

SEC

2010/10/12

JCMWN0262GB

IPDM E/R (INTELLIGENT POWER DISTRIBUTION MODULE ENGINE ROOM)

< ECU DIAGNOSIS INFORMATION >

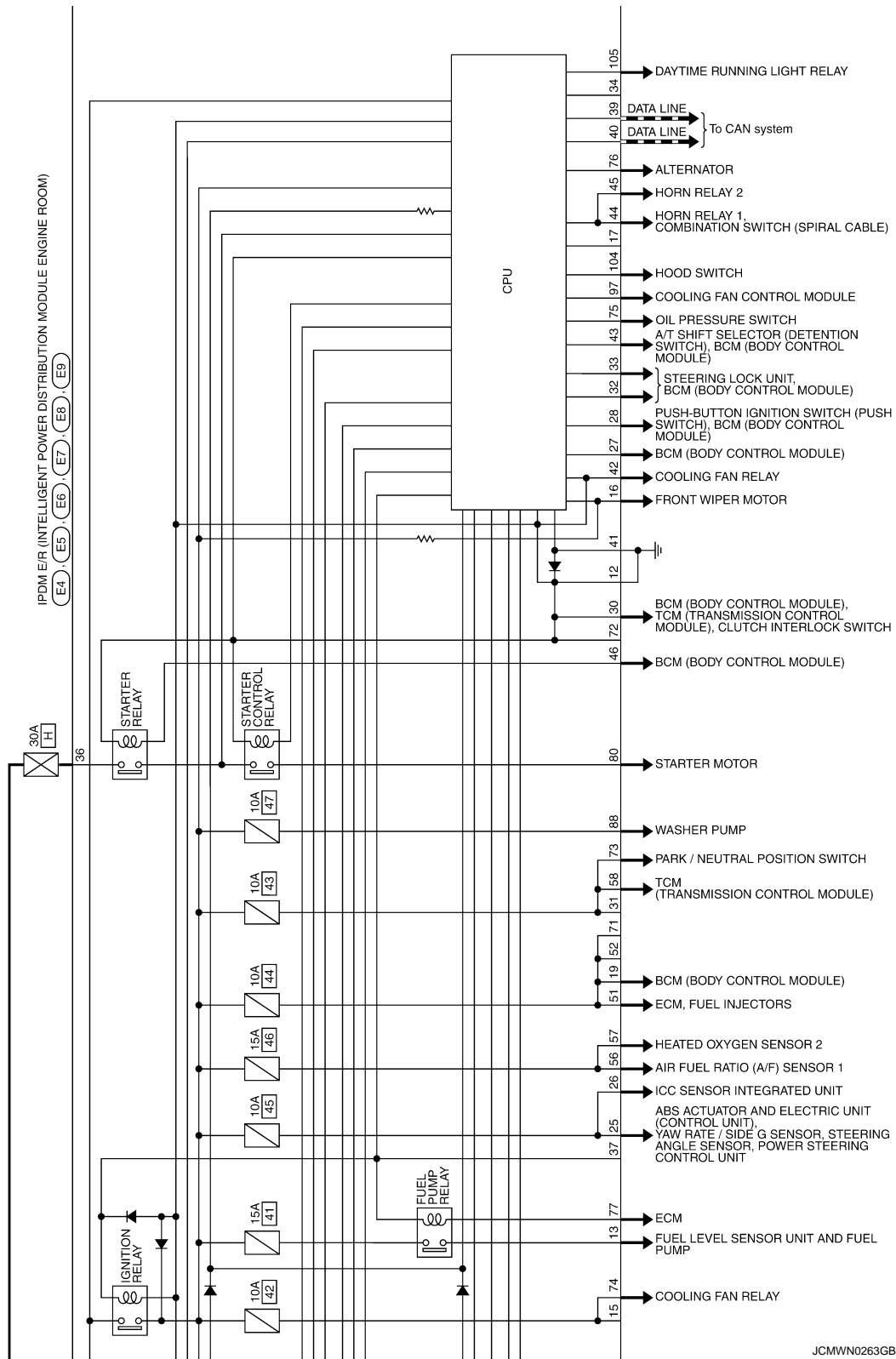

JCMWN0263GB

IPDM E/R (INTELLIGENT POWER DISTRIBUTION MODULE ENGINE ROOM)

< ECU DIAGNOSIS INFORMATION >

A
B
C
D
E
F
G
H
I
J
L
M
N
O
P

SEC

IPDM E/R
(INTELLIGENT POWER
DISTRIBUTION MODULE
ENGINE ROOM)
E4 E5 E6
E7 E8 E9

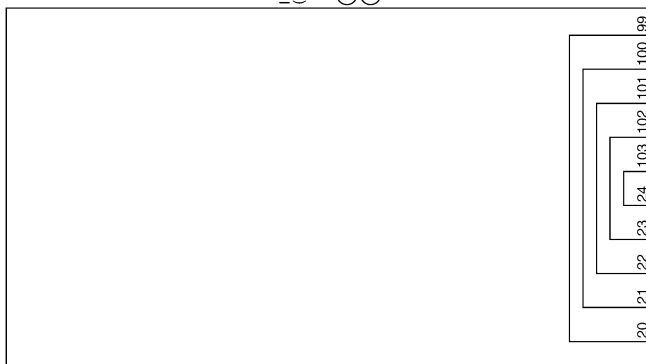

JCMWN0264GB

IPDM E/R (INTELLIGENT POWER DISTRIBUTION MODULE ENGINE ROOM)

< ECU DIAGNOSIS INFORMATION >

IPDM E/R (INTELLIGENT POWER DISTRIBUTION MODULE ENGINE ROOM)			
Terminal No.	Color of Wire	Signal Name [Specification]	
76	Y	-	
77	R	-	
80	W	-	
HS Connector No. E6 IPDM E/R (INTELLIGENT POWER DISTRIBUTION MODULE ENGINE ROOM) Connector Name Connector Type TH08FW-NH			
39	P	-	
40	L	-	
41	B/W	-	
42	Y	-	
43	SB	-	
44	LG	-	
45	G	-	
46	W	-	
HS Connector No. E7 IPDM E/R (INTELLIGENT POWER DISTRIBUTION MODULE ENGINE ROOM) Connector Name Connector Type TH20FW-CS12-M4			
9	B	-	
10	W	-	
11	L	-	
12	B/W	-	
13	Y	-	
14	LG	-	
15	W	-	
16	LG	-	
17	Y	-	
18	W	-	
19	W	-	
20	G	-	
21	R	-	
22	EG	-	
23	EG	-	
24	R	-	
25	G	-	
26	R	-	
27	EG	-	
28	L	-	
29	L	-	
30	GR	-	
31	Y	-	
32	V	-	
33	P	-	
34	P	-	
35	SB	-	
36	G	-	
37	SB	-	
38	SB	-	
HS Connector No. E4 IPDM E/R (INTELLIGENT POWER DISTRIBUTION MODULE ENGINE ROOM) Connector Name Connector Type TH08FW-MC			
HS Connector No. E5 IPDM E/R (INTELLIGENT POWER DISTRIBUTION MODULE ENGINE ROOM) Connector Name Connector Type TH20FW-CS12-M4-TV			
HS Connector No. E6 IPDM E/R (INTELLIGENT POWER DISTRIBUTION MODULE ENGINE ROOM) Connector Name Connector Type TH08FW-NH			
HS Connector No. E7 IPDM E/R (INTELLIGENT POWER DISTRIBUTION MODULE ENGINE ROOM) Connector Name Connector Type TH20FW-CS12-M4			
HS Connector No. E8 IPDM E/R (INTELLIGENT POWER DISTRIBUTION MODULE ENGINE ROOM) Connector Name Connector Type NS08FW-CS			
HS Connector No. E9 IPDM E/R (INTELLIGENT POWER DISTRIBUTION MODULE ENGINE ROOM) Connector Name Connector Type TH18FW-NH			

JCMWN0265GB

INFOID:000000006956336

Fail-safe

CAN COMMUNICATION CONTROL

When CAN communication with ECM and BCM is impossible, IPDM E/R performs fail-safe control. After CAN communication recovers normally, it also returns to normal control.

If No CAN Communication Is Available With ECM

IPDM E/R (INTELLIGENT POWER DISTRIBUTION MODULE ENGINE ROOM)

< ECU DIAGNOSIS INFORMATION >

Control part	Fail-safe operation
Cooling fan	<ul style="list-style-type: none"> • Outputs the pulse duty signal (PWM signal) 100% when the ignition switch is turned ON • Outputs the pulse duty signal (PWM signal) 0% when the ignition switch is turned OFF
A/C compressor	A/C relay OFF
Alternator	Outputs the power generation command signal (PWM signal) 0%

If No CAN Communication Is Available With BCM

Control part	Fail-safe operation
Headlamp	<ul style="list-style-type: none"> • Turns ON the headlamp low relay when the ignition switch is turned ON • Turns OFF the headlamp low relay when the ignition switch is turned OFF • Headlamp high relay OFF
<ul style="list-style-type: none"> • Parking lamps • Side maker lamp • License plate lamps • Illuminations • Tail lamps 	<ul style="list-style-type: none"> • Turns ON the tail lamp relay when the ignition switch is turned ON • Turns OFF the tail lamp relay when the ignition switch is turned OFF
Front wiper	<ul style="list-style-type: none"> • The status just before activation of fail-safe control is maintained until the ignition switch is turned OFF while the front wiper is operating at LO or HI speed. • The wiper is operated at LO speed until the ignition switch is turned OFF if the fail-safe control is activated while the front wiper is set in the INT mode and the front wiper motor is operating.
Horn	Horn relay OFF
Ignition relay	The status just before activation of fail-safe is maintained.
Starter motor	Starter control relay OFF
Steering lock unit*	Steering lock relay OFF

*: For models with steering lock unit

IGNITION RELAY MALFUNCTION DETECTION FUNCTION

- IPDM E/R monitors the voltage at the contact circuit and excitation coil circuit of the ignition relay inside it.
- IPDM E/R judges the ignition relay error if the voltage differs between the contact circuit and the excitation coil circuit.
- If the ignition relay cannot turn OFF due to contact seizure, it activates the tail lamp relay for 10 minutes to alert the user to the ignition relay malfunction when the ignition switch is turned OFF.

SEC

Voltage judgment		IPDM E/R judgment	Operation
Ignition relay contact side	Ignition relay excitation coil side		
ON	ON	Ignition relay ON normal	—
OFF	OFF	Ignition relay OFF normal	—
ON	OFF	Ignition relay ON stuck	<ul style="list-style-type: none"> • Detects DTC "B2098: IGN RELAY ON" • Turns ON the tail lamp relay for 10 minutes
OFF	ON	Ignition relay OFF stuck	Detects DTC "B2099: IGN RELAY OFF"

FRONT WIPER CONTROL

IPDM E/R detects front wiper stop position by a front wiper stop position signal.

When a front wiper stop position signal is in the conditions listed below, IPDM E/R stops power supply to wiper after repeating a front wiper 10 seconds activation and 20 seconds stop five times.

Ignition switch	Front wiper switch	Front wiper stop position signal
ON	OFF	The front wiper stop position signal (stop position) cannot be input for 10 seconds.
	ON	The front wiper stop position signal does not change for 10 seconds.

IPDM E/R (INTELLIGENT POWER DISTRIBUTION MODULE ENGINE ROOM)

< ECU DIAGNOSIS INFORMATION >

NOTE:

This operation status can be confirmed on the IPDM E/R “Data Monitor” that displays “BLOCK” for the item “WIP PROT” while the wiper is stopped.

STARTER MOTOR PROTECTION FUNCTION

IPDM E/R turns OFF the starter control relay to protect the starter motor when the starter control relay remains active for 90 seconds.

DTC Index

INFOID:000000006956337

NOTE:

- The details of time display are as follows.
 - CRNT: A malfunction is detected now.
 - PAST: A malfunction was detected in the past.
- IGN counter is displayed on FFD (Freeze Frame data).
 - The number is 0 when is detected now.
 - The number increases like 1 → 2 ... 38 → 39 after returning to the normal condition whenever IGN OFF → ON.
 - The number is fixed to 39 until the self-diagnosis results are erased if it is over 39.

×: Applicable

CONSULT display	Fail-safe	Refer to
No DTC is detected. further testing may be required.	—	—
U1000: CAN COMM CIRCUIT	×	PCS-15
B2098: IGN RELAY ON	×	PCS-16
B2099: IGN RELAY OFF	—	PCS-17
B2108: S/L RELAY ON*	—	SEC-98
B2109: S/L RELAY OFF*	—	SEC-100
B210A: S/L STATE SW*	—	SEC-101
B210B: START CONT RLY ON	—	SEC-105
B210C: START CONT RLY OFF	—	SEC-106
B210D: STARTER RELAY ON	—	SEC-107
B210E: STARTER RELAY OFF	—	SEC-108
B210F: INTRLCK/PNP SW ON	—	SEC-110
B2110: INTRLCK/PNP SW OFF	—	SEC-112

*: For models without steering lock unit, this DTC is not applied.

ENGINE DOES NOT START WHEN INTELLIGENT KEY IS INSIDE OF VEHICLE

< SYMPTOM DIAGNOSIS >

SYMPTOM DIAGNOSIS

ENGINE DOES NOT START WHEN INTELLIGENT KEY IS INSIDE OF VEHICLE

Description

INFOID:000000006472050

Engine does not start when push-button ignition switch is pressed while carrying Intelligent Key.

NOTE:

- Check that vehicle is under the condition shown in “Conditions of vehicle” before starting diagnosis, and check each symptom.
- The engine start function, door lock function, power distribution system, and NATS-IVIS/NVIS in the Intelligent Key system are closely related to each other regarding control. The vehicle security function can operate only when the door lock and power distribution system are operating normally.

Conditions of Vehicle (Operating Conditions)

- “ENGINE START BY I-KEY” in “WORK SUPPORT” is ON when setting on CONSULT-III.
- Intelligent Key is not inserted in key slot.
- One or more of Intelligent Keys with registered Intelligent Key ID is in the vehicle.

Diagnosis Procedure

INFOID:000000006472051

1. CHECK INTELLIGENT KEY SYSTEM (DOOR LOCK FUNCTION)

Lock/unlock door with door request switch.

Refer to [DLK-19, "DOOR LOCK FUNCTION : System Description"](#).

Is the operation normal?

YES >> GO TO 2.

NO >> Check Intelligent Key system (door lock function). Refer to [DLK-213, "ALL DOOR : Diagnosis Procedure"](#).

2. PERFORM WORK SUPPORT

Perform “INSIDE ANT DIAGNOSIS” on Work Support in “INTELLIGENT KEY”.

Refer to [SEC-25, "INTELLIGENT KEY : CONSULT-III Function \(BCM - INTELLIGENT KEY\)"](#).

>> GO TO 3.

3. PERFORM SELF DIAGNOSTIC RESULT

Perform Self Diagnostic Result in “BCM”, and check whether or not DTC of inside key antenna is detected.

Is DTC detected?

YES >> Refer to [DLK-62, "DTC Logic"](#) (instrument center), [DLK-64, "DTC Logic"](#) (console) or [DLK-66, "DTC Logic"](#) (trunk room).

NO >> GO TO 4.

4. CHECK PUSH-BUTTON IGNITION SWITCH

Check push-button ignition switch.

Refer to [PCS-66, "Component Function Check"](#).

Is the operation normal?

YES >> GO TO 5.

NO >> Repair or replace malfunctioning parts.

5. CONFIRM THE OPERATION

Confirm the operation again.

Is the inspection normal?

YES >> Check intermittent incident. Refer to [GI-43, "Intermittent Incident"](#).

NO >> GO TO 1.

A
B
C
D
E
F
G
H
I
J
L
M
N
O
P

SEC

STEERING DOES NOT LOCK

< SYMPTOM DIAGNOSIS >

STEERING DOES NOT LOCK

Description

INFOID:000000006472052

Steering does not lock when door is open while ignition switch is OFF.

NOTE:

Before performing the diagnosis, check "Work Flow". Refer to [SEC-5, "Work Flow"](#).

Diagnosis Procedure

INFOID:000000006472053

1. CHECK DOOR SWITCH

Check door switch.

Refer to [DLK-71, "Component Function Check"](#).

Is the inspection normal?

YES >> GO TO 2.

NO >> Repair or replace malfunctioning parts.

2. CONFIRM THE OPERATION

Confirm the operation again.

Is the inspection normal?

YES >> Check intermittent incident. Refer to [GI-43, "Intermittent Incident"](#).

NO >> GO TO 1.

SECURITY INDICATOR LAMP DOES NOT TURN ON OR FLASH

< SYMPTOM DIAGNOSIS >

SECURITY INDICATOR LAMP DOES NOT TURN ON OR FLASH

Description

INFOID:000000006472054

Security indicator lamp does not blink when ignition switch is in a position other than ON

NOTE:

- Before performing the diagnosis, check "Work Flow". Refer to [SEC-5, "Work Flow"](#).
- Check that vehicle is under the condition shown in "Conditions of vehicle" before starting diagnosis, and check each symptom.

Conditions of Vehicle (Operating Conditions)

- Intelligent Key is not inserted in key slot.
- Ignition switch is not in the ON position.

Diagnosis Procedure

INFOID:000000006472055

1. CHECK SECURITY INDICATOR LAMP

Check security indicator lamp.

Refer to [SEC-118, "Component Function Check"](#).

Is the inspection result normal?

YES >> GO TO 2.

NO >> Repair or replace the malfunctioning parts.

2. CONFIRM THE OPERATION

Confirm the operation again.

Is the result normal?

YES >> Check intermittent incident. Refer to [GI-43, "Intermittent Incident"](#).

NO >> GO TO 1.

A
B
C
D
E
F
G
H
I
J
L
M
N
O
P

SEC

VEHICLE SECURITY SYSTEM CANNOT BE SET

< SYMPTOM DIAGNOSIS >

VEHICLE SECURITY SYSTEM CANNOT BE SET INTELLIGENT KEY

INTELLIGENT KEY : Description

INFOID:000000006472056

Armed phase is not activated when door is locked using Intelligent Key.

NOTE:

Check that vehicle is under the condition shown in "Conditions of vehicle" before starting diagnosis, and check each symptom.

CONDITION OF VEHICLE (OPERATING CONDITION)

Confirm the setting of "SECURITY ALARM SET" in "WORK SUPPORT" in "THEFT ALM" using CONSULT-III.

INTELLIGENT KEY : Diagnosis Procedure

INFOID:000000006472057

1. CHECK INTELLIGENT KEY SYSTEM (REMOTE KEYLESS ENTRY FUNCTION)

Lock/unlock door with Intelligent Key.

Refer to [DLK-28. "REMOTE KEYLESS ENTRY FUNCTION : System Description"](#).

Is the inspection result normal?

YES >> GO TO 2.

NO >> Check Intelligent Key system (remote keyless entry function). Refer to [DLK-215. "Diagnosis Procedure"](#).

2. CHECK HOOD SWITCH

Check hood switch.

Refer to [SEC-116. "Component Function Check"](#).

Is the inspection result normal?

YES >> GO TO 3.

NO >> Repair or replace the malfunctioning parts.

3. CONFIRM THE OPERATION

Confirm the operation again.

Is the result normal?

YES >> Check intermittent incident. Refer to [GI-43. "Intermittent Incident"](#).

NO >> GO TO 1.

DOOR REQUEST SWITCH

DOOR REQUEST SWITCH : Description

INFOID:000000006472058

Armed phase is not activated when door is locked using door request switch.

NOTE:

Check that vehicle is under the condition shown in "Conditions of vehicle" before starting diagnosis, and check each symptom.

CONDITION OF VEHICLE (OPERATING CONDITION)

Confirm the setting of "SECURITY ALARM SET" in "WORK SUPPORT" in "THEFT ALM" using CONSULT-III.

DOOR REQUEST SWITCH : Diagnosis Procedure

INFOID:000000006472059

1. CHECK INTELLIGENT KEY SYSTEM (DOOR LOCK FUNCTION)

Lock/unlock door with door request switch.

Refer to [DLK-19. "DOOR LOCK FUNCTION : System Description"](#).

Is the inspection result normal?

YES >> GO TO 2.

NO >> Check Intelligent Key system (door lock function). Refer to [DLK-213. "ALL DOOR : Diagnosis Procedure"](#).

2. CHECK HOOD SWITCH

VEHICLE SECURITY SYSTEM CANNOT BE SET

< SYMPTOM DIAGNOSIS >

Check hood switch.

Refer to [SEC-116, "Component Function Check"](#).

Is the inspection result normal?

YES >> GO TO 3.

NO >> Repair or replace the malfunctioning parts.

3.CONFIRM THE OPERATION

Confirm the operation again.

Is the result normal?

YES >> Check intermittent incident. Refer to [GI-43, "Intermittent Incident"](#).

NO >> GO TO 1.

A

B

C

D

E

F

G

H

I

J

SEC

L

M

N

O

P

VEHICLE SECURITY ALARM DOES NOT ACTIVATE

< SYMPTOM DIAGNOSIS >

VEHICLE SECURITY ALARM DOES NOT ACTIVATE

Description

INFOID:000000006472060

Alarm does not operate when alarm operating condition is satisfied.

NOTE:

Check that vehicle is under the condition shown in "Conditions of vehicle" before starting diagnosis, and check each symptom.

CONDITIONS OF VEHICLE (OPERATING CONDITIONS)

"SECURITY ALARM SET" in "WORK SUPPORT" of "THEFT ALM" is ON when setting on CONSULT-III.

Diagnosis Procedure

INFOID:000000006472061

1.CHECK DOOR SWITCH

Check door switch.

Refer to [DLK-71, "Component Function Check"](#).

Is the inspection result normal?

YES >> GO TO 2.

NO >> Replace the malfunctioning door switch

2.CHECK HOOD SWITCH

Check hood switch.

Refer to [SEC-116, "Component Function Check"](#).

Is the inspection result normal?

YES >> GO TO 3.

NO >> Repair or replace the malfunctioning parts.

3.CHECK HEADLAMP FUCTION

Check headlamp function.

Refer to [EXL-83, "Component Function Check"](#).

Is the inspection result normal?

YES >> GO TO 4.

NO >> Repair or replace the malfunctioning parts.

4.CHECK HORN FUNCTION

Check horn function.

Refer to [HRN-2, "Wiring Diagram - HORN -"](#).

Is the inspection result normal?

YES >> GO TO 5.

NO >> Repair or replace the malfunctioning parts.

5.CONFIRM THE OPERATION

Confirm the operation again.

Is the result normal?

YES >> Check intermittent incident. Refer to [GI-43, "Intermittent Incident"](#).

NO >> GO TO 1.

INTELLIGENT KEY INSERT INFORMATION DOES NOT OPERATE

< SYMPTOM DIAGNOSIS >

INTELLIGENT KEY INSERT INFORMATION DOES NOT OPERATE

Description

INFOID:000000006472062

Intelligent Key insert information does not operate when push-button ignition switch is operated while Intelligent Key is not inside vehicle.

NOTE:

Warning functions operating condition is extremely complicated. During operation confirmation reconfirm the list above twice in order to ensure proper operation. Refer to [DLK-36, "WARNING FUNCTION : System Description"](#).

Diagnosis Procedure

INFOID:000000006472063

1.CHECK POWER POSITION

Check if ignition switch position is changing or not.

Does ignition switch position change?

YES >> GO TO 3.

NO >> GO TO 2.

2.CHECK PUSH-BUTTON IGNITION SWITCH

Check push-button ignition switch.

Refer to [DLK-115, "Component Function Check"](#).

Is the inspection result normal?

YES >> Check BCM for DTC. Refer to [SEC-187, "DTC Index"](#).

NO >> Repair or replace the malfunctioning parts.

3.CHECK DOOR SWITCH

Check door switch.

Refer to [DLK-71, "Component Function Check"](#).

Is the inspection result normal?

YES >> GO TO 4.

NO >> Repair or replace the malfunctioning parts.

4.CHECK KEY SLOT

Check key slot.

Refer to [DLK-110, "Component Function Check"](#).

Is the inspection result normal?

YES >> GO TO 5.

NO >> Repair or replace the malfunctioning parts.

5.CHECK COMBINATION METER DISPLAY

Check combination meter display.

Refer to [DLK-114, "Component Function Check"](#).

Is the inspection result normal?

YES >> GO TO 6.

NO >> Repair or replace the malfunctioning parts.

6.CHECK KEY SLOT INDICATOR

Check key slot indicator.

Refer to [DLK-112, "Component Function Check"](#).

Is the inspection result normal?

YES >> GO TO 7.

NO >> Repair or replace the malfunctioning parts.

7.CONFIRM THE OPERATION

Confirm the operation again.

Is the result normal?

A

B

C

D

E

F

G

H

I

J

SEC

L

M

N

O

P

INTELLIGENT KEY INSERT INFORMATION DOES NOT OPERATE

< SYMPTOM DIAGNOSIS >

YES >> Check intermittent incident. Refer to [GI-43, "Intermittent Incident"](#).
NO >> GO TO 1.

PANIC ALARM FUNCTION DOES NOT OPERATE

< SYMPTOM DIAGNOSIS >

PANIC ALARM FUNCTION DOES NOT OPERATE

Description

INFOID:000000006472064

NOTE:

- Before performing the diagnosis following procedure, check “Work Flow”. Refer to [SEC-5, "Work Flow"](#).
- Check that vehicle is under the condition shown in “Conditions of vehicle” before starting diagnosis, and check each symptom.

CONDITIONS OF VEHICLE (OPERATION CONDITIONS)

- Ignition switch is in OFF or LOCK position.
- Intelligent Key is removed from key slot.

Diagnosis Procedure

INFOID:000000006472065

1.CHECK REMOTE KEYLESS ENTRY FUNCTION

Check remote keyless entry function.

Does door lock/unlock with Intelligent key button?

YES >> GO TO 2.

NO >> Go to [DLK-11, "System Description"](#).

2.CHECK VEHICLE SECURITY ALARM OPERATION

Check vehicle security alarm operation.

Does alarm (headlamp and horn) active?

YES >> GO TO 3.

NO >> Go to [SEC-20, "System Description"](#).

3.CHECK “PANIC ALARM SET” SETTING IN “WORK SUPPORT”

Check “PANIC ALARM SET” setting in “WORK SUPPORT”.

Refer to [SEC-25, "INTELLIGENT KEY : CONSULT-III Function \(BCM - INTELLIGENT KEY\)"](#).

Is the inspection result normal?

YES >> GO TO 4.

NO >> Set “PANIC ALARM SET” setting in “WORK SUPPORT”.

4.CONFIRM THE OPERATION

Confirm the operation again.

Is the result normal?

YES >> Check intermittent incident. Refer to [GI-43, "Intermittent Incident"](#).

NO >> GO TO 1.

A
B
C
D
E
F
G
H
I
J
L
M
N
O
P

SEC

PRECAUTIONS

< PRECAUTION >

PRECAUTION

PRECAUTIONS

Precaution for Supplemental Restraint System (SRS) "AIR BAG" and "SEAT BELT PRE-TENSIONER"

INFOID:000000006472066

The Supplemental Restraint System such as "AIR BAG" and "SEAT BELT PRE-TENSIONER", used along with a front seat belt, helps to reduce the risk or severity of injury to the driver and front passenger for certain types of collision. This system includes seat belt switch inputs and dual stage front air bag modules. The SRS system uses the seat belt switches to determine the front air bag deployment, and may only deploy one front air bag, depending on the severity of a collision and whether the front occupants are belted or unbelted. Information necessary to service the system safely is included in the "SRS AIR BAG" and "SEAT BELT" of this Service Manual.

WARNING:

Always observe the following items for preventing accidental activation.

- To avoid rendering the SRS inoperative, which could increase the risk of personal injury or death in the event of a collision that would result in air bag inflation, all maintenance must be performed by an authorized NISSAN/INFINITI dealer.
- Improper maintenance, including incorrect removal and installation of the SRS, can lead to personal injury caused by unintentional activation of the system. For removal of Spiral Cable and Air Bag Module, see "SRS AIR BAG".
- Never use electrical test equipment on any circuit related to the SRS unless instructed to in this Service Manual. SRS wiring harnesses can be identified by yellow and/or orange harnesses or harness connectors.

PRECAUTIONS WHEN USING POWER TOOLS (AIR OR ELECTRIC) AND HAMMERS

WARNING:

Always observe the following items for preventing accidental activation.

- When working near the Air Bag Diagnosis Sensor Unit or other Air Bag System sensors with the ignition ON or engine running, never use air or electric power tools or strike near the sensor(s) with a hammer. Heavy vibration could activate the sensor(s) and deploy the air bag(s), possibly causing serious injury.
- When using air or electric power tools or hammers, always switch the ignition OFF, disconnect the battery, and wait at least 3 minutes before performing any service.

Service Procedure Precautions for Models with a Pop-up Roll Bar

INFOID:000000006472067

WARNING:

Always observe the following items for preventing accidental activation.

- Risk of passenger injury or death may increase if the pop-up roll bar does not deploy during a roll over collision. In order to reduce the chance of an incident where the pop-up roll bar is inoperative, all maintenance must be performed by a NISSAN or INFINITI dealer.
- Before removing and installing the pop-up roll bar component parts and harness, always turn the ignition switch OFF, disconnect the battery negative terminal, and wait for 3 minutes or more. (The purpose of this operation is to discharge electricity that is accumulated in the auxiliary power supply circuit in the air bag diagnosis sensor unit.)
- When repairing, removing, and installing a pop-up roll bar, always refer to SRS AIR BAG and SRS AIR BAG CONTROL warnings in the Service Manual.

Precautions Necessary for Steering Wheel Rotation After Battery Disconnection

INFOID:000000006472068

CAUTION:

Comply with the following cautions to prevent any error and malfunction.

- Before removing and installing any control units, first turn the ignition switch to the LOCK position, then disconnect both battery cables.
- After finishing work, confirm that all control unit connectors are connected properly, then re-connect both battery cables.
- Always use CONSULT to perform self-diagnosis as a part of each function inspection after finishing work. If a DTC is detected, perform trouble diagnosis according to self-diagnosis results.

PRECAUTIONS

< PRECAUTION >

For vehicle with steering lock unit, if the battery is disconnected or discharged, the steering wheel will lock and cannot be turned.

If turning the steering wheel is required with the battery disconnected or discharged, follow the operation procedure below before starting the repair operation.

OPERATION PROCEDURE

1. Connect both battery cables.

NOTE:

Supply power using jumper cables if battery is discharged.

2. Turn the ignition switch to ACC position.
(At this time, the steering lock will be released.)
3. Disconnect both battery cables. The steering lock will remain released with both battery cables disconnected and the steering wheel can be turned.
4. Perform the necessary repair operation.
5. When the repair work is completed, re-connect both battery cables. With the brake pedal released, turn the ignition switch from ACC position to ON position, then to LOCK position. (The steering wheel will lock when the ignition switch is turned to LOCK position.)
6. Perform self-diagnosis check of all control units using CONSULT.

Precaution for Procedure without Cowl Top Cover

INFOID:000000006472069

When performing the procedure after removing cowl top cover, cover the lower end of windshield with urethane, etc to prevent damage to windshield.

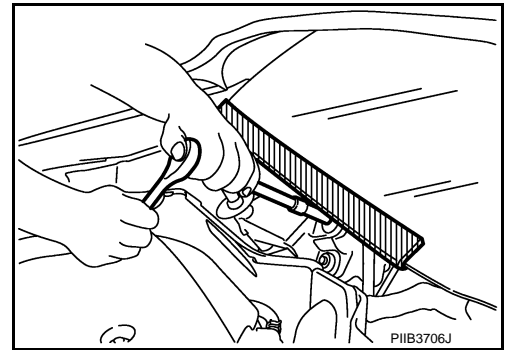

Precaution for Battery Service

INFOID:000000006472070

Before disconnecting the battery, lower both the driver and passenger windows. This will prevent any interference between the window edge and the vehicle when the door is opened/closed. During normal operation, the window slightly raises and lowers automatically to prevent any window to vehicle interference. The automatic window function will not work with the battery disconnected.

A
B
C
D
E
F
G
H
I
J
L
M
N
O
P

SEC

KEY SLOT

< REMOVAL AND INSTALLATION >

REMOVAL AND INSTALLATION

KEY SLOT

Exploded View

INFOID:000000006472071

Refer to [IP-12, "A/T MODELS : Exploded View"](#) (A/T models), [IP-23, "M/T MODELS : Exploded View"](#) (M/T models).

Removal and Installation

INFOID:000000006472072

REMOVAL

1. Remove the instrument driver lower panel (2). Refer to [IP-13, "A/T MODELS : Removal and Installation"](#) (A/T models), [IP-24, "M/T MODELS : Removal and Installation"](#) (M/T models).
2. Disconnect key slot connector.
3. Remove the key slot mounting screw (A), and then remove key slot (1) from instrument driver lower panel (2).

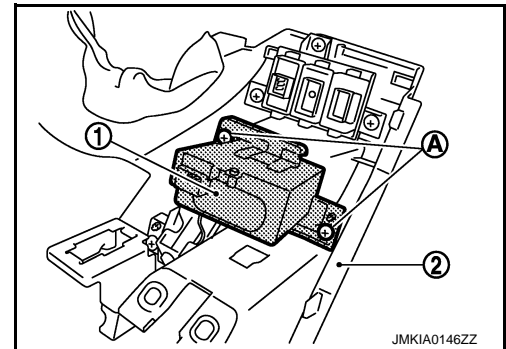

INSTALLATION

Install in the reverse order of removal.

PUSH BUTTON IGNITION SWITCH

< REMOVAL AND INSTALLATION >

PUSH BUTTON IGNITION SWITCH

Exploded View

INFOID:000000006472073

Refer to [IP-12. "A/T MODELS : Exploded View"](#) (A/T models), [IP-23. "M/T MODELS : Exploded View"](#) (M/T models).

Removal and Installation

INFOID:000000006472074

REMOVAL

1. Remove the cluster lid A assembly. Refer to [IP-13. "A/T MODELS : Removal and Installation"](#) (A/T models), [IP-24. "M/T MODELS : Removal and Installation"](#) (M/T models).
2. Remove the push-button ignition switch (1) from cluster lid A assembly, and then remove pawl (A). Press push-button ignition switch (1) back to disengage from cluster lid A assembly.

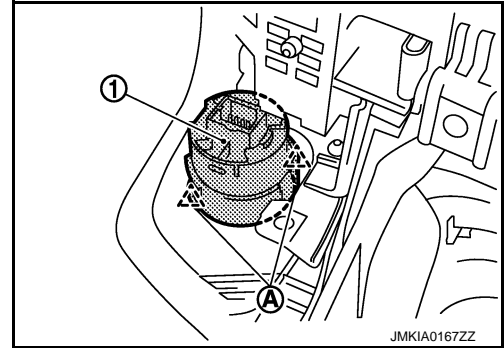

INSTALLATION

Install in the reverse order of removal.

A
B
C
D
E
F
G
H
I
J
L
M
N
O
P

SEC